

EFFICIENT

2016 - 2017

WORK EFFICIENT
WORK WITH SONIC

Welcome to the world of Sonic



WE PROUDLY PRESENT YOU OUR NEW CATALOGUE FOR THE YEAR 2016-2017.

SONIC IS A UNIQUE AND PROFESSIONAL TOOL BRAND SPECIALISED IN THE DEVELOPMENT AND PRODUCTION OF HAND TOOLS, TOOL STORAGE SYSTEMS AND SPECIALTY TOOLS. SONIC HAS A CLEAR VISION AND A MISSION AND CONTINUES WHERE OTHERS STOP. THE SONIC TEAM STRIVES TO PROVIDE TOOL STORAGE SOLUTIONS, HAND TOOLS AND SPECIALISED TOOLS THAT ARE OF THE HIGHEST QUALITY, FUNCTION AND PERFORMANCE TO BEST SERVE ITS GLOBAL CUSTOMERS. SONIC IS REPRESENTED IN 62 COUNTRIES. THE HEADQUARTERS AND THE SONIC EXPERIENCE CENTER ARE SITUATED IN PURMEREND, THE NETHERLANDS.

SONIC OFFERS:

- QUICK DELIVERY
- 10 YEAR WARRANTY
- HIGHEST AVAILABILITY
- THE BEST VALUE FOR MONEY
- EXTENDED RANGE OF PRODUCTS
- PROFESSIONAL TOOL STORAGE SYSTEMS
- HIGH SERVICE
- AN EASY ACCESSIBLE WEBSITE



WE WOULD LIKE TO INVITE YOU TO VISIT OUR WEBSITE WWW.SONIC-EQUIPMENT.COM TO EXPLORE THE WORLD OF SONIC.
WORK EFFICIENT, WORK WITH SONIC!

WORK EFFICIENT
WORK WITH SONIC

Sonic headquarters



Contents

EMPTY STORAGE SYSTEMS	
▪ S7 TOOL BOX	12
▪ S8 TOOL BOX	13
▪ S9 TOOL BOX	14
▪ S9 VAS TOOL BOX	15
▪ S10 TOOL BOX	16
▪ S10 GLASS TOOL BOX	17
▪ S11 TOOL BOX	18
▪ S12 TOOL BOX	19
▪ S12 XD TOOL BOX	20
▪ S12 VAS TOOL BOX	21
▪ S13 TOOL BOX	22
▪ S14 TOOL BOX	23
▪ S15 TOOL BOX	24
▪ SERVICE CARTS	25
▪ TOP BOXES	26
▪ SUITCASES	27
▪ SONIC WORK STATION (SWS)	28
▪ MASTER WORK STATION (MWS)	32
▪ MODULAR STORAGE SYSTEM (MSS)	36
▪ TOOL BOX SPARE PARTS	54
FILLED STORAGE SYSTEMS	
▪ BLACK SERIES TOOL BOXES	64
▪ S7 TOOL BOX	69
▪ S8 TOOL BOXES	70
▪ S9 TOOL BOXES	72
▪ S10 TOOL BOXES	76
▪ S11 TOOL BOXES	96
▪ S12 TOOL BOXES	96
▪ S12 XD TOOL BOX	106
▪ S13 TOOL BOXES	108
▪ S14 TOOL BOXES	110
▪ S15 TOOL BOXES	112
▪ FILLED SUITCASES	114
▪ FILLED MINI TOP BOXES	117
▪ FILLED TOOL BOX	118
▪ S9 FILLED TOP BOXES	119
TOOLS SETS SONIC FOAM SYSTEM (SFS)	123
BLOW MOULD CASE STORAGE (BMCS)	145
SOCKETS ON RAIL	155
GENERAL TOOLS	161
▪ SCREWDRIVERS	161
▪ SOCKETS	163
▪ WRENCHES	165
AUTO SPECIAL TOOLS	167
▪ ASSORTMENTS	189
▪ SPRING COMPRESSORS	194
▪ FLOOR JACKS	197
▪ POWER LIGHTS	201
▪ BOOSTERS	207
▪ POWER PACKS	216
TIMING TOOLS	217
DISPLAY TOOLS	241
SAE TOOLS	247
TOOLS PARTS	
▪ SCREWDRIVERS	255
▪ SOCKETS	261
▪ WRENCHES	271
▪ HEX AND STAR KEYS	277
▪ PLIERS, HAMMERS, CHISELS, FILES, MEASURING AND CUTTING TOOLS	283
▪ RATCHETS, EXTENSIONS, SLIDING T HANDLES, UNIVERSAL JOINTS, ADAPTORS	295
▪ TORQUE WRENCHES	301
▪ SOCKET BITS, BITS	303
PROMOTIONAL ITEMS	311
WARRANTY	313
CONVERSION TABLE FROM INCHES TO MILIMETRES	314
CONVERSION TABLES FOR TORQUE WRENCHES	315
GALLERY	316
INDEX	320
ALPHA INDEX	325

Symbols



SOCKET FLANK 6 PT



SOCKET 12 PT



SOCKET TX



SOCKET SPLINE



SLOTTED



PH



PZ



SQUARE



(BIT) HEX



(BIT) HEX BALL



(BIT) TX TAMPERPROOF



(BIT) TX BALL



(BIT) STAR



(BIT) TS 5 PT TAMPERPROOF



(BIT) SPLINE 12 PT



(BIT) SPLINE 12 PT TAMPERPROOF



(BIT) RIBE



24 TEETH



45 TEETH



48 TEETH



60 TEETH



72 TEETH



QUICK RELEASE



FLEXIBLE HEAD



SWIVEL HEAD



ROTATABLE HEAD

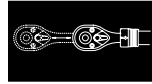

EXTENDABLE



MORE INFO WWW.SONIC-EQUIPMENT.COM



VDE TESTED, VOLTAGE WITH STAND STRENGTH UP TO 1000 VOLT



GS-TUV QUALITY



BLOW MOULD CASE STORAGE



6,3MM (1/4") SQUARE



10MM (3/8") SQUARE



12,5MM (1/2") SQUARE



20MM (3/4") SQUARE



25MM (1") SQUARE



1 YEAR WARRANTY



2 YEAR WARRANTY



3 YEAR WARRANTY



NO WARRANTY



SONIC WARRANTY

THIS SONIC CATALOGUE (SONIC 16-17), CANCELS ALL PREVIOUS CATALOGUES. ALL ILLUSTRATIONS ARE UNRETOUCHED AND THE TOOLS ARE ORIGINATING FROM CURRENT PRODUCTION OR FROM STOCK. THE MEASURES GIVEN IN THIS CATALOGUE ARE NOT BINDING. WHILST EVERY EFFORT HAS BEEN MADE TO ENSURE ACCURACY OF INFORMATION GIVEN IN THE SONIC 2015 CATALOGUE OUR POLICY OF CONTINUOUS IMPROVEMENT DETERMINES THAT WE RESERVE THE RIGHT TO DEVIATE FROM PRINTED DETAILS WITHOUT PRIOR NOTICE TO KEEP PACE WITH LATEST DEVELOPMENTS. COPYRIGHT: ALL TEXT, PHOTOS AND ILLUSTRATIONS ARE PROTECTED BY COPYRIGHT. NO PART OF THIS MATERIAL MAY BE REPRODUCED WITHOUT OUR WRITTEN PERMISSION.

sonic-equipment.com

sonic
equipment

Storage systems | Forklifts | Hand tools | Hot air | Special tools | Hoists | Maintenance

ALSO AUDI C.ABT RACING RELIES ON SONIC

WORK EFFICIENT
WORK WITH SONIC

S7 S8 S9 S10 S11 S12 S13

Sonic Corporate Store
Take a look around in the world of Sonic

Black Series
View the Black Series

New items
Have a look at the new Sonic articles

Promotion 16
Landed brochures

Welcome to the Sonic World

Webshop
Login
New Customer
Terms & Conditions
Privacy Conditions

Downloads
Catalogue
Presentation Flyers

Press
New products
Exhibitions
Sonic in images

Newsletters
03 - 2016
28th Anniversary 2016
02 - 2016
01 - 2016
04 - 2015

Extra
About Sonic Equipment
Jobs
Security and Privacy
Downloads

Sign up for our newsletter

sonic
equipment

SONIC EQUIPMENT BV | COMPANY POLY NV | 1444 BT PUNENBURG | THE NETHERLANDS | T +31 20 494 422 000 | F +31 20 494 422 010 | [INFO@SONIC-EQUIPMENT.COM](mailto:info@sonic-equipment.com)



FOLLOW US. SIGN IN FOR NEWSLETTER ON WWW.SONIC-EQUIPMENT.COM

WELCOME TO THE WORLD OF SONIC

SONIC IS REPRESENTED IN 62 COUNTRIES

ARUBA | AUSTRALIA | AUSTRIA | BARBADOS | BELGIUM | BONAIRE | BOSNIA AND HERZEGOVINA | CHILE | CHINA | CROATIA | CURACAO | CYPRUS | CZECH REPUBLIC | DENMARK
DOMINICAN REPUBLIC | DUTSLAND | ECUADOR | ESTONIA | FINLAND | FRANCE | GREAT BRITAIN / UNITED KINGDOM | GREECE | HUNGARY | ICELAND | INDIA | INDONESIA | IRAN | IRELAND
ISRAEL | ITALY | JORDAN | KOREA | LATVIA | LEBANON | LITHUANIA | LUXEMBOURG | MACEDONIA | MALAYSIA | MAURITIUS | NETHERLANDS | NIGERIA | NORWAY | PAKISTAN | POLAND
PORTUGAL | ROMANIA | SAINT MARTEN | SAUDI ARABIA | SERBIA | SINGAPORE | SLOVAKIA | SLOVENIA | SRI LANK | SURINAM | SWEDEN | SWITZERLAND | TAIWAN | THAILAND
TRINIDAD AND TOBAGO | UNITED ARAB EMIRATES | UNITED STATES OF AMERICA | VIETNAM



USA



SONIC IS PROUD TO BE
TECHNICAL PARTNER OF
THE PORSCHE GT4 TEAM
CJ WILSON USA.

USA



SONIC TAKES OFF AT FULL
THROTTLE IN THE USA.
WE ARE OFFICIAL PARTNER
OF IMSA.

USA



BECAUSE OF ROADSHOWS
AND EXHIBITIONS SONIC IS
GETTING FAMOUS IN THE USA
VERY QUICKLY.

GERMANY



SONIC HAS DEVELOPED
SPECIAL VAS-ITEMS FOR
VOLKSWAGEN AG

BELGIUM



THE WELL-KNOWN RACING TEAM PHOENIX RACING HAS PARTNERED WITH SONIC

FRANCE



THE FERRARI TEAM SCUDERIA CORSA HAS FINISHED SECOND AT THE 24 HOURS OF LE MANS

USA



ALSO PRIVATE GARAGES USE MWS AND MSS



DUBAI



THE AUDI C.ABT RACING TEAM HAS BECOME 3RD AT THE 24-HOURS RACE OF DUBAI.

NETHERLANDS



ALSO BIKE SHOPS USE SONIC

DAKAR



ALSO IN EXTREME CIRCUMSTANCES YOU CAN RELY ON SONIC.

GERMANY

TECHNICAL PARTNER

WE ARE VERY PROUD TO BE THE TECHNICAL PARTNER OF BENTLEY C.ABT RACING TEAM FOR THE COMING YEARS.

GERMANY



WE ARE PROUD SPONSOR OF BLACK FALCON GERMANY



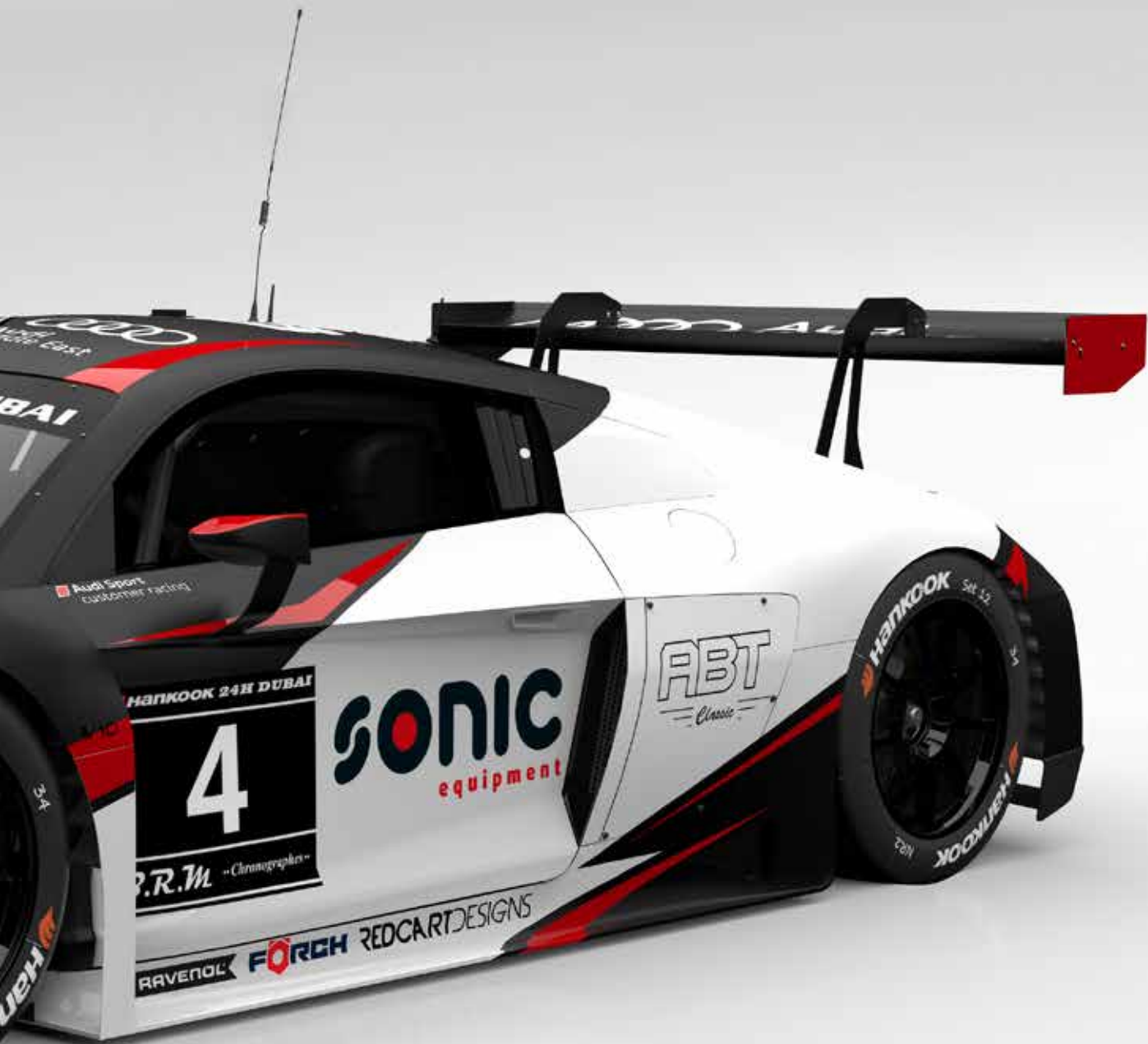

WORK EFFICIENT
WORK WITH SONIC

Explore Sonic



Sonic Equipment
Joined 1 month ago

15 Videos 0 Likes 0 Comments 0 Collections 0 Members 0 Followers

Videos

Sonic Equipment Corporate Movie EU

Welcome to the world of Sonic!
SONIC is a unique and professional tool brand specialised in the development and production of hand tools, tool storage systems and specialised tools. SONIC has a clear vision and a mission and continues where others stop.

The SONIC Team strives to provide tool storage solutions, hand tools and specialist tools that are of the highest quality, function and performance to best serve its global customers. SONIC is represented in 82 countries.

The Headquarters and the SONIC Experience Center are situated in Pijnacker, The Netherlands.

SONIC offers:

- Quick delivery
- 10 year warranty
- Highest reliability
- The best value for money
- Extended range of products
- Professional tool storage systems
- High service
- An easy accessible website

We would like to invite you to visit our website sonic-equipment.com to explore the world of SONIC.

Work efficiently, work with SONIC!

EXPLORE THE WORLD OF SONIC!
WATCH OUR VIDEOS ONLINE:
VIMEO.COM/SONICEQUIPMENT



sonic
equipment

WORK EFFICIENTLY
WORK WITH SONIC

QUARTERLY NEWS Q3-2016
NOV. 3 - 2016

MWS-MSS
The Sonic Modular Work Station(MWS) and the Modular Storage System(MSS) are practical storage solutions in the regular workshop as well as in the larger workshop. Mercedes-Benz, Porsche and Lamborghini are provided with a Sonic storage solution. The demand for our MWS and MSS is increasing. For every demand we can make a suitable solution. That's our challenge!

BMCS
Our Blow Mould Case Storage(BMCS) is a heavy designed Sonic product line with injection blow-mould gys handles and heavy spring loading clips. Sonic offers multiple color variants with different tool fittings in attractively designed forms. The BMCS are now available on our website.

B M C S
BLOW MOULD CASE STORAGE

TIMING TOOLS
The complete new line of Sonic Timing Tools is now available. In the first week of August we write for an independent distributor on our website where your 200 products can be ordered. In our next newsletter additional information will be provided.

STT **SONIC**
TIMING TOOLS

NEW LED LIGHTS
The completely renewed series of LED lights can now be ordered. Here in our selection is our headlamp. The new LED lights are extremely powerful and feature high performance LED technology. This results in a more so strong light intensity than conventional lamps. All LED lights can be charged by USB (USB cable included).

WE HOPE YOU WILL ENJOY READING
THIS CATALOGUE. IF YOU WANT TO READ MORE,
PLEASE SUBSCRIBE TO OUR NEWSLETTER VIA:
WWW.SONIC-EQUIPMENT.COM

Empty storage systems



S7



S8



S9



S9
TOPBOX



S10



S11



S12



S12
XD



S13



S14



S15



ISWS
SONIC
WORK
STATION



IMWS
SONIC
WORK
STATION



IMSS
SONIC
WORK
STATION

S7 tool box

THE SONIC S7 TOOL BOX IS A NEWLY DESIGNED TOOL BOX WITH A INTEGRATED CAN HOLDER. THE S7 TOOL BOX HAS A POWDER COATING EXTERIOR AND IS AVAILABLE IN BLACK.

ART. NO. 4733716

MAIN FEATURES

- 6 DRAWERS;
- 4 SHALLOW DRAWERS (DIM. 575 X 370 X 60MM)
- 2 DEEP DRAWERS (DIM. 575 X 370 X 137MM)
- NO DRAWER RELEASE SYSTEM INTGREGATED
- POWDER COATING EXTERIOR
- FRONT CENTRALIZED SAFETY LOCK
- FOLDING KEYS
- CAN HOLDER
- ABS TOP BLADE
- 4 CASTERS Ø 100MM, WHEREOF 2 SWIVEL CASTERS WITH ROLLING AND TURNING BRAKE
- OVERALL WEIGHT: 48KG
- STATIC LOAD CAPACITY: 400KG
- DRAWER CAPACITY: 40KG
- DIMENSIONS IN MM: W 731 X D 463 X H 911
- AVAILABLE IN: BLACK RAL 9004

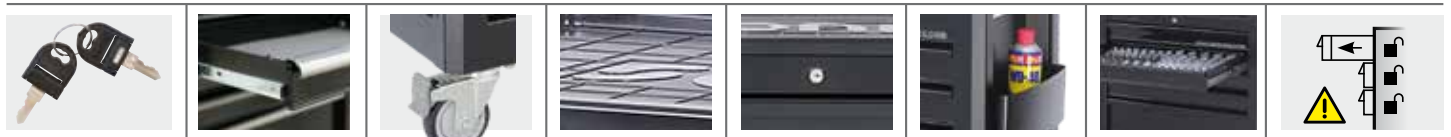

FOLDING KEY

BALL BEARING SLIDES. STATIC RESISTANCE 40 KG

4 CASTERS Ø 100MM, WHEREOF 2 SWIVEL CASTERS WITH ROLLING AND TURNING BRAKE

ABS TOP BLADE

FRONT CENTRALIZED SAFETY LOCK

CAN HOLDER

NO DRAWER RELEASE SYSTEM INTEGRATED

NEVER OPEN MORE THAN 1 DRAWER EACH TIME, TO PREVENT TIPPING OVER!

DIMENSIONS

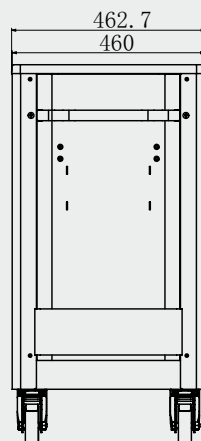
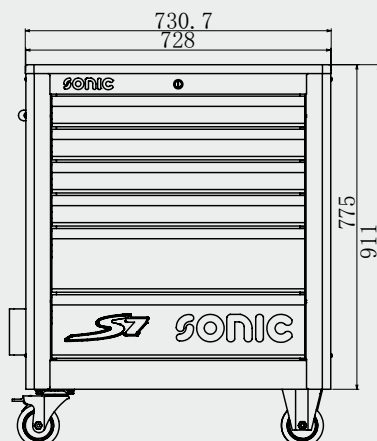

BUILD YOUR OWN UNIQUE S7 TOOL BOX

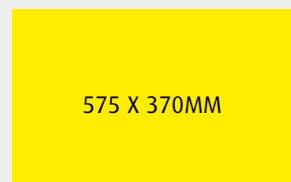

575 X 370MM



1/3

1/3

1/3

190 X 370MM

190 X 370MM

190 X 370MM

FOAM SYSTEM DRAWER

S8 tool box

THE SONIC S8 TROLLEY HAS A DRAWERS A RELEASE SYSTEM INTEGRATED WITHIN THE HANDLE, TO PREVENT MULTIPLE DRAWERS TO OPEN AT ONCE. THE S8 IS EQUIPED WITH 7 DRAWERS OPERATED BY BALL BEARING SLIDES. THE TOOL BOX IS PROVIDED WITH A POWDER COATING EXTERIOR WHICH IS AVAILABLE IN BLACK.

02

ART. NO. 4730167

MAIN FEATURES

- IN TOTAL 7 DRAWERS;
- 5 SHALLOW DRAWERS (DIM. 575 X 370 X 65MM)
- 2 DEEP DRAWERS (DIM. 575 X 370 X 145MM)
- SIDE HANDLE
- POWDER COATING
- ANTI-SLIP FOAM MAT
- INTEGRATED DRAWER LOCKING PREVENTS UNWANTED OPENING OF THE DRAWERS
- 100% RETRACTABLE DRAWERS
- BALL-BEARING DRAWERS
- FRONT CENTRALIZED SAFETY-LOCK
- LOCK INCLUDING 2 FOLDING KEYS
- CAN HOLDER
- RUBBER CASTERS (Ø 125MM-50MM) 2 SWIVEL CASTERS WITH BRAKE AND 2 FIXED CASTERS
- NET WEIGHT: 67KG
- MAXIMUM LOAD: 400KG
- DRAWERS LOADABLE UP TO 40KG
- DIMENSIONS IN MM: W 690 X D 460 X H 1020
- AVAILABLE IN: BLACK RAL 9004

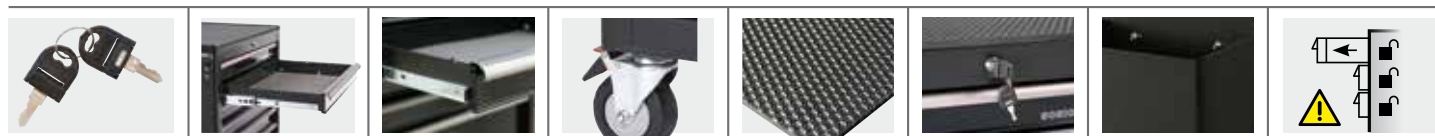

FOLDING KEY

SAFETY DRAWERS RELEASE SYSTEM INTEGRATED WITHIN THE HANDLE

BALL BEARING SLIDES. STATIC RESISTANCE 40 KG

4 EXTRA LARGE WHEELS Ø125MM, WHEREOF 2 CASTERS WITH ROLLING AND TURNING BRAKE

WORKTOP MADE FROM EVA

FRONT CENTRALIZED SAFETY LOCK

CAN HOLDER

NEVER OPEN MORE THAN 1 DRAWER EACH TIME TO PREVENT TIPPING OVER!

DIMENSIONS

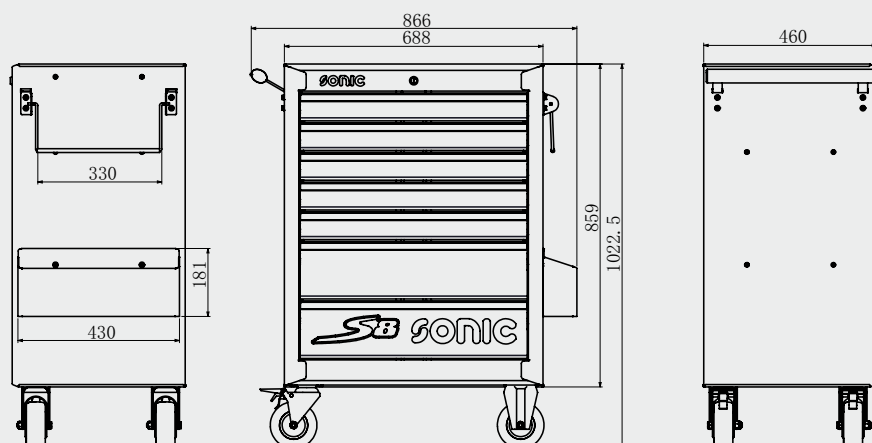

BUILD YOUR OWN UNIQUE S8 TOOL BOX

575 X 370MM

1/3

190 X 370MM

1/3

190 X 370MM

1/3

190 X 370MM

FOAM SYSTEM DRAWER

S9 tool box

THE SONIC S9 TOOL BOX IS EQUIPPED WITH 8 DRAWERS. THE TOOL BOX IS PROVIDED WITH A DARK GREY COLOR EXTERIOR. THE ANGLES OF THE TOOL BOX HAVE A STRENGTHENING PROFILE, WHICH RESULTS IN MORE FIRMNESS AND STABILITY FOR A LONGER LIFE CYCLE.

ART. NO. 4732418

MAIN FEATURES

- IN TOTAL 8 DRAWERS;
- 7 SHALLOW DRAWERS (DIM. 575 X 370 X 60MM)
- 1 DEEP DRAWER (DIM. 575 X 370 X 145MM)
- SIDE HANDLE
- TORSION RESISTANT THROUGH PROFILE CONSTRUCTION AT THE 4 CORNERS
- PLASTIC EDGE PROTECTION
- PERFORATED PANELS TO HANG UP VARIOUS ACCESSORIES
- POWDER COATING
- STAINLESS STEEL WORKTOP
- DRAWER BLOCKING SYSTEM AS PROTECTION AGAINST TIPPING OVER
- 100% RETRACTABLE DRAWERS
- BALL-BEARING DRAWERS
- FRONT CENTRALIZED SAFETY-LOCK
- LOCK INCLUDING 2 FOLDING KEYS
- CAN HOLDER
- PAPER ROLL HOLDER
- 4 RUBBER CASTERS (Ø 125MM-50MM)
- 2 SWIVEL CASTERS WITH BRAKE AND 2 FIXED CASTERS
- NET WEIGHT: 84KG
- MAXIMUM LOAD: 400KG
- DRAWERS LOADABLE UP TO 40KG
- DIMENSIONS IN MM: W 589 X D 532 X H 1035
- AVAILABLE IN: GREY RAL 7011



FOLDING KEY

HANDLE

INCLUDING PAPER ROLL HOLDER

4 EXTRA LARGE WHEELS Ø125MM, WHEREOF 2 CASTERS WITH ROLLING AND TURNING BRAKE

STAINLESS STEEL TOPBLADE

FRONT CENTRALIZED SAFETY LOCK

CAN HOLDER

SAFETY DRAWER BLOCKING SYSTEM, PROTECTION AGAINST TIPPING OVER

DIMENSIONS

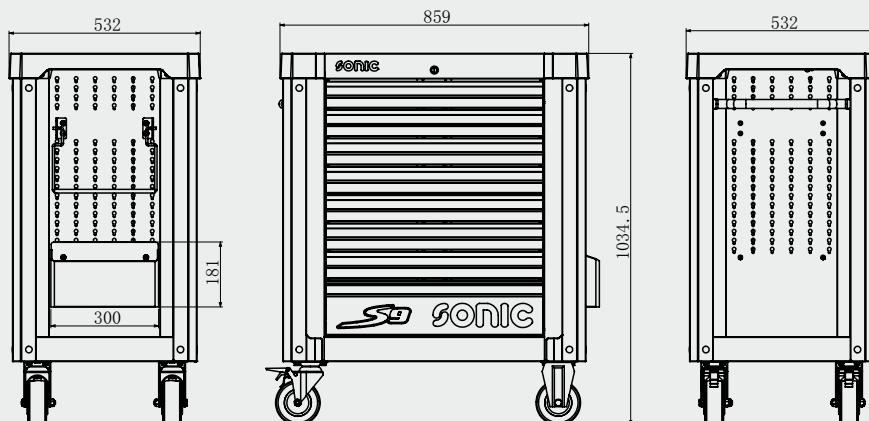

BUILD YOUR OWN UNIQUE S9 TOOL BOX

575 X 370MM

1/3

190 X 370MM

1/3

190 X 370MM

1/3

190 X 370MM

FOAM SYSTEM DRAWER

S9 VAS tool box

AFTER A LONG SELECTION PROCEDURE VOLKSWAGEN HAS DECIDED TO START A COLLABORATION WITH SONIC EQUIPMENT. ESPECIALLY FOR VOLKSWAGEN SONIC HAS DEVELOPED 2 TOOL BOXES. BOTH ARE BASED ON THE S9 AND S12 TOOL BOX. THESE TOOL BOXES ARE DELIVERED IN THE VOLKSWAGEN RAL COLOURS AND CAN BE SUPPLIED WITH FOAM INLETS SPECIALLY DEVELOPED FOR VOLKS-WAGEN. THE RANGE CONSISTS OF A BASIC TOOL SET IN FOAM INLETS AND ADDITIONAL EXTENSION SETS FOR AUDI, VW AND BODY. THESE PRODUCTS ARE EXCLUSIVELY AVAILABLE AT VOLKSWAGEN AND THEIR DISTRIBUTION CENTERS.

02

ART. NO. ASE27600300000

MAIN FEATURES

- IN TOTAL 8 DRAWERS;
- 7 SHALLOW DRAWERS (DIM. 575 X 370 X 60MM)
- 1 DEEP DRAWER (DIM. 575 X 370 X 145MM)
- SIDE HANDLE
- TORSION RESISTANT THROUGH PROFILE CONSTRUCTION AT THE 4 CORNERS
- PLASTIC EDGE PROTECTION
- PERFORATED PANELS TO HANG UP VARIOUS ACCESSORIES
- POWDER COATING
- STAINLESS STEEL WORKTOP
- DRAWER BLOCKING SYSTEM AS PROTECTION AGAINST TIPPING OVER
- 100% RETRACTABLE DRAWERS
- BALL-BEARING DRAWERS
- FRONT CENTRALIZED SAFETY-LOCK
- LOCK INCLUDING 2 FOLDING KEYS
- CAN HOLDER
- PAPER ROLL HOLDER
- 4 RUBBER CASTERS (Ø 125MM-50MM)
- 2 SWIVEL CASTERS WITH BRAKE AND 2 FIXED CASTERS
- NET WEIGHT: 84KG
- MAXIMUM LOAD: 400KG
- DRAWERS LOADABLE UP TO 40KG
- DIMENSIONS IN MM: W 589 X D 532 X H 1035
- AVAILABLE IN: GREY RAL 7021

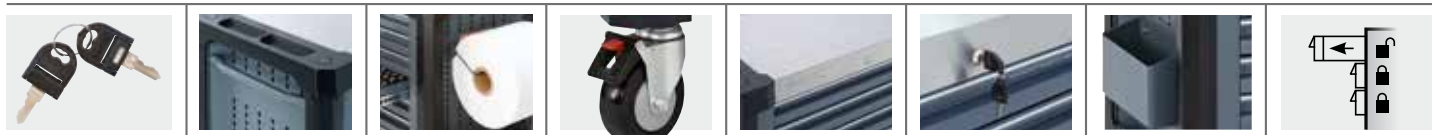

FOLDING KEY

HANDLE

INCLUDING PAPER ROLL HOLDER

4 EXTRA LARGE WHEELS Ø125MM, WHEREOF 2 CASTERS WITH ROLLING AND TURNING BRAKE

STAINLESS STEEL TOPBLADE

FRONT CENTRALIZED SAFETY LOCK

CAN HOLDER

SAFETY DRAWER BLOCKING SYSTEM, PROTECTION AGAINST TIPPING OVER

DIMENSIONS

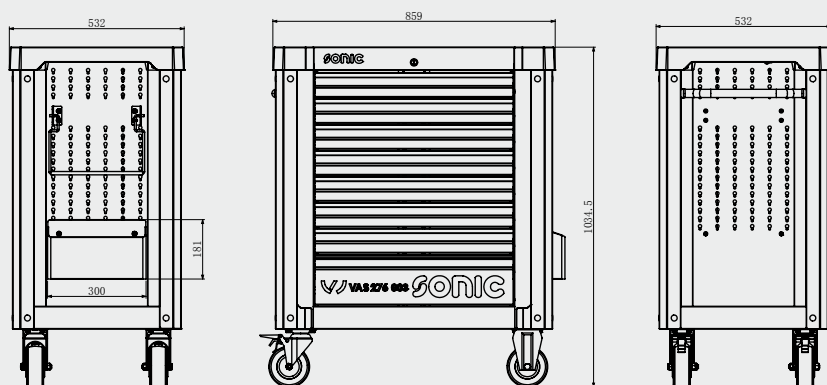

YOU CAN FIND MORE SETS ON OUR WEBSITE.



VAS 275 001/4

ASE 275 002 00 D00

S10 tool box

THE SONIC S10 TOOL BOX HAS INTEGRATED CAN AND PAPER ROLL HOLDERS. THE S10 IS EQUIPPED WITH 8 DRAWERS AS WELL AS THE LATEST BALL BEARING SLIDES. THE TOOL BOX IS PROVIDED WITH A POWDER COATING EXTERIOR WHICH IS AVAILABLE IN BLACK, RED, BLUE AND GREY COLOR.



ART. NO. 4730918 4730928 4730938 4730948

MAIN FEATURES

- IN TOTAL 8 DRAWERS;
 - 7 SHALLOW DRAWERS (DIM. 575 X 370 X 65MM)
 - 1 DEEP DRAWER (DIM. 575 X 370 X 145MM)
- SIDE HANDLE
- TORSION RESISTANT THROUGH PROFILE CONSTRUCTION AT THE 4 CORNERS
- POWDER COATING
- PLASTIC WORKTOP
- DRAWER BLOCKING SYSTEM AS PROTECTION AGAINST TIPPING OVER
- 100% RETRACTABLE DRAWERS
- BALL-BEARING DRAWERS
- FRONT CENTRALIZED SAFETY-LOCK
- LOCK INCLUDING 2 FOLDING KEYS
- 2 EXTRA STORAGE TRAYS ON THE BACK
- 2 INTEGRATED CAN HOLDER
- INTEGRATED PAPER ROLL HOLDER
- INTEGRATED TRASH CAN
- 4 RUBBER CASTERS (Ø 125MM-50MM) 2 SWIVEL CASTERS WITH BRAKE AND 2 FIXED CASTERS
- NET WEIGHT: 91KG
- MAXIMUM LOAD: 400KG
- DRAWERS LOADABLE UP TO 40KG
- DIMENSIONS IN MM: W 880 X D 570 X H 1050
- AVAILABLE IN: BLACK RAL 9004 - RED RAL 3001 - BLUE RAL 5005 - GREY RAL 7040



FOLDING KEY

100% RETRACTABLE DRAWERS WITH BALL BEARING SLIDES

DRAWER RELEASE SYSTEM, NO MECHANISM IN THE HANDLE

4 EXTRA LARGE WHEELS Ø125MM, WHEREOF 2 CASTERS WITH ROLLING AND TURNING BRAKE

INCLUDING PAPER ROLL HOLDER

GARBAGE BIN

INTEGRATED CAN HOLDERS

SAFETY DRAWER BLOCKING SYSTEM, PROTECTION AGAINST TIPPING OVER

DIMENSIONS

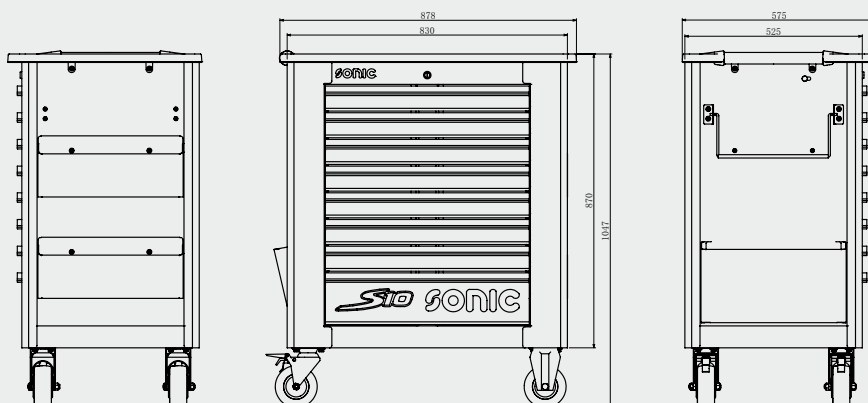

BUILD YOUR OWN UNIQUE S10 TOOL BOX

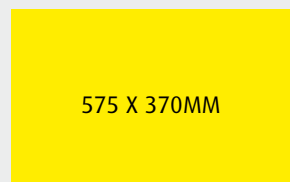

575 X 370MM



1/3

190 X 370MM

1/3

190 X 370MM

1/3

190 X 370MM

FOAM SYSTEM DRAWER

S10 glass box

TO SERVICE WINDSHIELDS, WE OFFER A SPECIAL TOOL BOX. THIS S10 TOOL BOX HAS 5 DRAWERS IN TOTAL, 3 OF THEM ARE DEEPER DRAWERS. ON THE BACK OF THE TOOL BOX, A MOUNTED MECHANISM IS ATTACHED TO HOLD THE PANES OF GLASS. THE S10 TOOL BOX IS DESIGNED WITH INTEGRATED CAN AND PAPER ROLL HOLDERS, PROVIDED WITH A POWDER COATING EXTERIOR WHICH IS AVAILABLE IN BLACK COLOR.

02

ART. NO. 4733115

MAIN FEATURES

- IN TOTAL 5 DRAWERS;
- 2 SHALLOW DRAWERS (DIM. 575 X 370 X 65MM)
- 2 DEEP DRAWERS (DIM. 575 X 370 X 145MM)
- 2 EXTRA DEEP DRAWERS (DIM. 575 X 370 X 230MM)
- ADJUSTABLE WINDSCREEN HOLDER
- SIDE HANDLE
- TORSION RESISTANT THROUGH PROFILE CONSTRUCTION AT THE 4 CORNERS
- POWDER COATING
- PLASTIC WORKTOP
- DRAWER BLOCKING SYSTEM AS PROTECTION AGAINST TIPPING OVER
- 100% RETRACTABLE DRAWERS
- BALL-BEARING DRAWERS
- FRONT CENTRALIZED SAFETY-LOCK
- LOCK INCLUDING 2 FOLDING KEYS
- 2 EXTRA STORAGE TRAYS ON THE BACK
- 2 INTEGRATED CAN HOLDER
- INTEGRATED PAPER ROLL HOLDER
- INTEGRATED TRASH CAN
- 4 RUBBER CASTERS (Ø 125MM-50MM)
- 2 SWIVEL CASTERS WITH BRAKE AND 2 FIXED CASTERS
- NET WEIGHT: 91KG
- MAXIMUM LOAD: 400KG
- DRAWERS LOADABLE UP TO 40KG
- DIMENSIONS IN MM: W 880 X D 570 X H 1050
- AVAILABLE IN: BLACK RAL 9004



DIMENSIONS

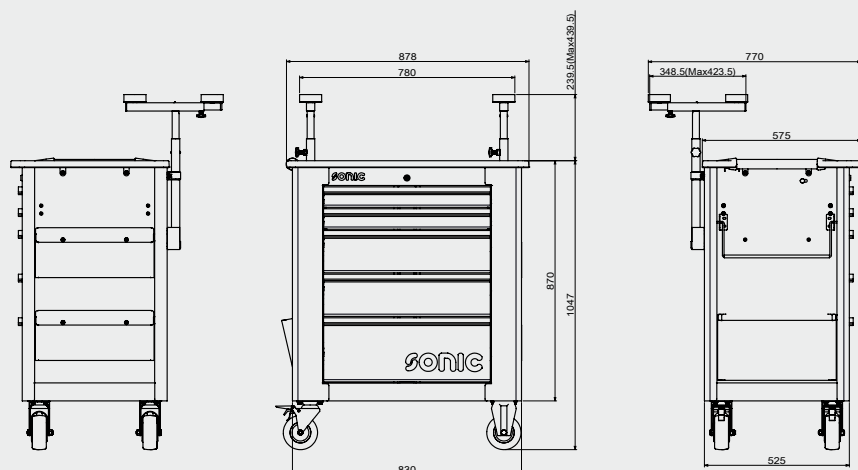

S11 tool box

THE SONIC S11 IS A TOOL BOX WITH INTEGRATED CAN AND PAPER ROLL HOLDERS. THE S11 IS EQUIPED WITH 8 DRAWERS AS WELL AS THE LATEST AUTO RETURN BALL BEARING SLIDES. THE TOOL BOX IS PROVIDED WITH A POWDER COATING EXTERIOR WHICH IS AVAILABLE IN BLACK, RED, BLUE AND GREY COLOR.

ART. NO. 4731118 4731128 4731138 4731148

MAIN FEATURES

- IN TOTAL 8 DRAWERS;
- 7 SHALLOW DRAWERS (DIM. 740 X 435 X 65MM)
- 1 DEEP DRAWER (DIM. 740 X 435 X 145MM)
- SIDE HANDLE
- TORSION RESISTANT THROUGH PROFILE CONSTRUCTION AT THE 4 CORNERS
- POWDER COATING
- PLASTIC WORKTOP
- DRAWER BLOCKING SYSTEM AS PROTECTION AGAINST TIPPING OVER
- 100% RETRACTABLE DRAWERS
- BALL-BEARING DRAWERS
- FRONT CENTRALIZED SAFETY-LOCK
- LOCK INCLUDING 2 FOLDING KEYS
- 2 EXTRA STORAGE TRAYS ON THE BACK
- 2 INTEGRATED CAN HOLDERS
- INTEGRATED PAPER ROLL HOLDER
- INTEGRATED TRASH CAN
- 4 RUBBER CASTERS (Ø 125MM-50MM)
- 2 SWIVEL CASTERS WITH BRAKE AND 2 FIXED CASTERS
- NET WEIGHT: 107KG
- MAXIMUM LOAD: 400KG
- DRAWERS LOADABLE UP TO 40KG
- DIMENSIONS IN MM: W 1045 X D 630 X H 1050
- AVAILABLE IN: BLACK RAL 9004 - RED RAL 3001 - BLUE RAL 5005 - GREY RAL 7040



FOLDING KEY

100% RETRACTABLE DRAWERS WITH BALL BEARING SLIDES

DRAWER RELEASE SYSTEM, NO MECHANISM IN THE HANDLE

4 EXTRA LARGE WHEELS Ø125MM, WHEREOF 2 CASTERS WITH ROLLING AND TURNING BRAKE

INCLUDING PAPER ROLL HOLDER

GARBAGE BIN

INTEGRATED CAN HOLDERS

SAFETY DRAWER BLOCKING SYSTEM, PROTECTION AGAINST TIPPING OVER

DIMENSIONS

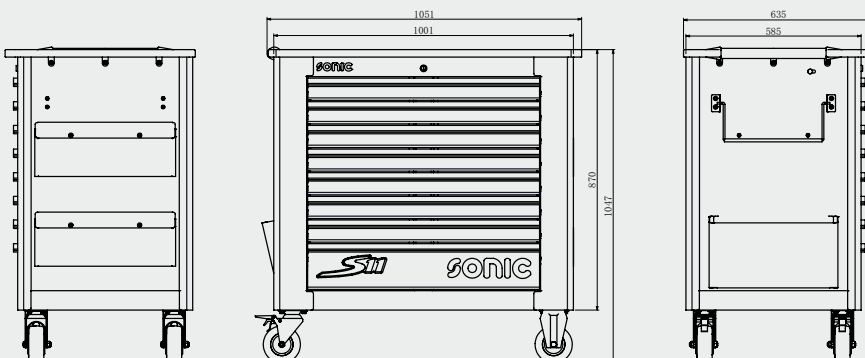

BUILD YOUR OWN UNIQUE S11 TOOL BOX

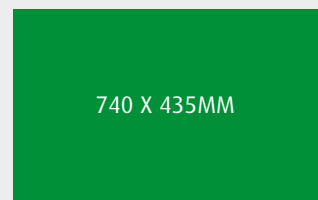

740 X 435MM

FOAM SYSTEM DRAWER

S12 tool box

THE SONIC S12 TOOL BOX IS EQUIPPED WITH 8 DRAWERS. THE TOOL BOX IS PROVIDED WITH A DARK GREY COLOR EXTERIOR. THE ANGLES OF THE TOOL BOX HAVE A STRENGTHENING PROFILE, WHICH RESULTS IN MORE FIRMNESS AND STABILITY FOR A LONGER LIFE CYCLE.

02

ART. NO. 4732718

MAIN FEATURES

- IN TOTAL 8 DRAWERS;
- 7 SHALLOW DRAWERS (DIM. 740 X 435 X 65MM)
- 1 DEEP DRAWER (DIM. 740 X 435 X 145MM)
- SIDE HANDLE
- TORSION RESISTANT THROUGH PROFILE CONSTRUCTION AT THE 4 CORNERS
- PLASTIC EDGE PROTECTION
- PERFORATED PANELS TO HANG UP VARIOUS ACCESSORIES
- POWDER COATING
- STAINLESS STEEL WORKTOP
- DRAWER BLOCKING SYSTEM AS PROTECTION AGAINST TIPPING OVER
- 100% RETRACTABLE DRAWERS
- BALL-BEARING DRAWERS
- FRONT CENTRALIZED SAFETY-LOCK
- LOCK INCLUDING 2 FOLDING KEYS
- CAN HOLDER
- PAPER ROLL HOLDER
- 4 RUBBER CASTERS (Ø 125MM-50MM) 2 SWIVEL CASTERS WITH BRAKE AND 2 FIXED CASTERS
- NET WEIGHT: 97KG
- MAXIMUM LOAD: 400KG
- DRAWERS LOADABLE UP TO 40KG
- DIMENSIONS IN MM: W 1030 X D 532 X H 1035
- AVAILABLE IN: GREY RAL 7011



FOLDING KEY

HANDLE

INCLUDING PAPER ROLL HOLDER

4 EXTRA LARGE WHEELS Ø125MM, WHEREOF 2 CASTERS WITH ROLLING AND TURNING BRAKE

STAINLESS STEEL TOPBLADE

FRONT CENTRALIZED SAFETY LOCK

CAN HOLDER

SAFETY DRAWER BLOCKING SYSTEM, PROTECTION AGAINST TIPPING OVER

DIMENSIONS

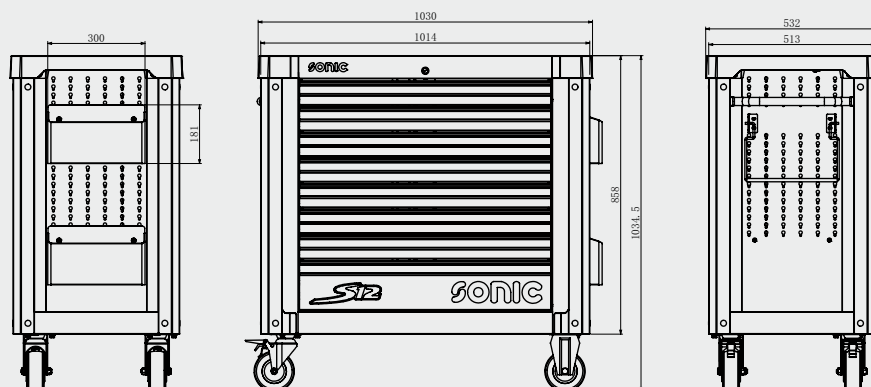

BUILD YOUR OWN UNIQUE S12 TOOL BOX

740 X 435MM

FOAM SYSTEM DRAWER

S12 XD tool box (extra deep)

THE SONIC S12XD TOOL BOX IS A NEWLY DESIGNED TOOL BOX EQUIPPED WITH 8 EXTRA DEEP DRAWERS. THE TOOL BOX IS PROVIDED WITH A DARK GREY COLOR EXTERIOR. THE ANGLES OF THE TOOL BOX HAVE A STRENGTHENING PROFILE, WHICH RESULTS IN MORE FIRMNESS AND STABILITY FOR A LONGER LIFE CYCLE.

ART. NO. 4734218

MAIN FEATURES

- IN TOTAL 8 DRAWERS;
- 7 SHALLOW DRAWERS (DIM. 740 X 575 X 65MM)
- 1 DEEP DRAWER (DIM. 740 X 575 X 145MM)
- SIDE HANDLE
- TORSION RESISTANT THROUGH PROFILE CONSTRUCTION AT THE 4 CORNERS
- PLASTIC EDGE PROTECTION
- PERFORATED PANELS TO HANG UP VARIOUS ACCESSORIES
- POWDER COATING
- STAINLESS STEEL WORKTOP
- DRAWER BLOCKING SYSTEM AS PROTECTION AGAINST TIPPING OVER
- 100% RETRACTABLE DRAWERS
- BALL-BEARING DRAWERS
- FRONT CENTRALIZED SAFETY-LOCK
- LOCK INCLUDING 2 FOLDING KEYS
- CAN HOLDER
- PAPER ROLL HOLDER
- 4 RUBBER CASTERS (Ø 125MM-50MM) 2 SWIVEL CASTERS WITH BRAKE AND 2 FIXED
- NET WEIGHT: 123KG
- MAXIMUM LOAD: 400KG
- DRAWERS LOADABLE UP TO 40KG
- DIMENSIONS IN MM: W 1030 X D 532 X H 1035
- AVAILABLE IN: GREY RAL 7011



FOLDING KEY

HANDLE

INCLUDING PAPER ROLL HOLDER

4 EXTRA LARGE WHEELS Ø125MM, WHEREOF 2 CASTERS WITH ROLLING AND TURNING BRAKE

STAINLESS STEEL TOPBLADE

FRONT CENTRALIZED SAFETY LOCK

CAN HOLDER

SAFETY DRAWER BLOCKING SYSTEM, PROTECTION AGAINST TIPPING OVER

DIMENSIONS

EXTRA DEEP

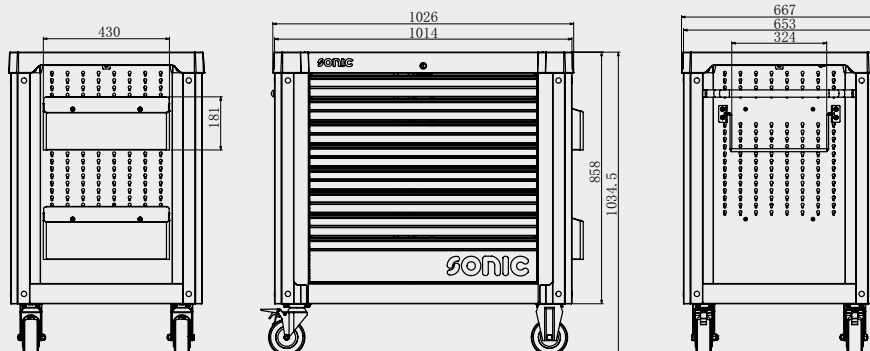

BUILD YOUR OWN UNIQUE S12 XD TOOL BOX

740 X 575MM	1/3 190 X 370MM
	1/3 190 X 370MM
	1/3 190 X 370MM

FOAM SYSTEM DRAWER

S12 VAS tool box

AFTER A LONG SELECTION PROCEDURE VOLKSWAGEN HAS DECIDED TO START A COLLABORATION WITH SONIC EQUIPMENT. ESPECIALLY FOR VOLKSWAGEN SONIC HAS DEVELOPED 2 TOOL BOXES. BOTH ARE BASED ON THE S9 AND S12 TOOL BOX. THESE TOOL BOXES ARE DELIVERED IN THE VOLKSWAGEN RAL COLOURS AND CAN BE SUPPLIED WITH FOAM INLETS SPECIALLY DEVELOPED FOR VOLKS-WAGEN. THE RANGE CONSISTS OF A BASIC TOOL SET IN FOAM INLETS AND ADDITIONAL EXTENSION SETS FOR AUDI, VW AND BODY. THESE PRODUCTS ARE EXCLUSIVELY AVAILABLE AT VOLKSWAGEN AND THEIR DISTRIBUTION CENTERS.

02

ART. NR. ASE27600100000



MAIN FEATURES

- IN TOTAL 8 DRAWERS;
- 7 SHALLOW DRAWERS (DIM. 740 X 435 X 65MM)
- 1 DEEP DRAWER (DIM. 740 X 435 X 145MM)
- SIDE HANDLE
- TORSION RESISTANT THROUGH PROFILE CONSTRUCTION AT THE 4 CORNERS
- PLASTIC EDGE PROTECTION
- PERFORATED PANELS TO HANG UP VARIOUS ACCESSORIES
- POWDER COATING
- STAINLESS STEEL WORKTOP
- DRAWER BLOCKING SYSTEM AS PROTECTION AGAINST TIPPING OVER
- 100% RETRACTABLE DRAWERS
- BALL-BEARING DRAWERS
- FRONT CENTRALIZED SAFETY-LOCK
- LOCK INCLUDING 2 FOLDING KEYS
- CAN HOLDER
- PAPER ROLL HOLDER
- 4 RUBBER CASTERS (Ø 125MM-50MM) 2 SWIVEL CASTERS WITH BRAKE AND 2 FIXED
- NET WEIGHT: 97KG
- MAXIMUM LOAD: 400KG
- DRAWERS LOADABLE UP TO 40KG
- DIMENSIONS IN MM: W 1030 X D 532 X H 1035
- AVAILABLE IN: GREY RAL 7021

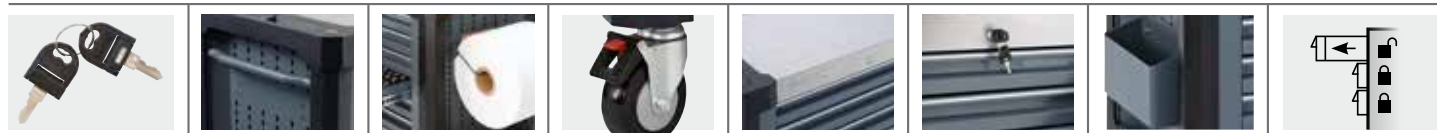

FOLDING KEY

HANDLE

INCLUDING PAPER ROLL HOLDER

4 EXTRA LARGE WHEELS Ø125MM, WHEREOF 2 CASTERS WITH ROLLING AND TURNING BRAKE

STAINLESS STEEL TOPBLADE

FRONT CENTRALIZED SAFETY LOCK

CAN HOLDER

SAFETY DRAWER BLOCKING SYSTEM, PROTECTION AGAINST TIPPING OVER

DIMENSIONS

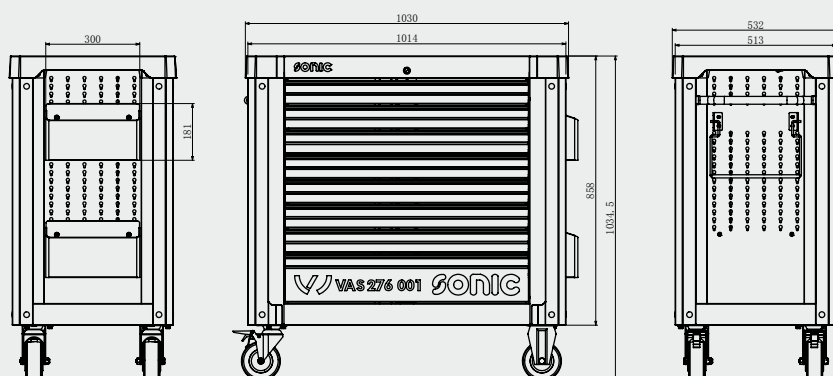

YOU CAN FIND MORE SETS ON OUR WEBSITE.



VAS 275 001/4

ASE 275 002 00 D00

S13 tool box

THE SONIC S13 IS A TOOL BOX WITH WOODEN TOP BLADE, CAN HOLDER, GARBAGE BIN, DOCUMENT HOLDER AND PAPER ROLL HOLDER. THE S13 IS EQUIPED WITH IN TOTAL 2 DEEP, 9 SHALLOW AND 2 SMALL DRAWERS AS WELL AS BALL BEARING SLIDES. THE TOOL BOX IS PROVIDED WITH A POWDER COATING EXTERIOR WHICH IS AVAILABLE IN BLACK COLOR.

ART. NO. 47308113

MAIN FEATURES

- IN TOTAL 13 DRAWERS;
- 9 SHALLOW DRAWERS (DIM. 575 X 370 X 65MM)
- 2 DEEP DRAWERS (DIM. 575 X 370 X 145MM)
- 2 SMALL DRAWERS (DIM. 145 X 370 X 65MM)
- SIDE HANDLE
- TORSION RESISTANT THROUGH PROFILE CONSTRUCTION AT THE 4 CORNERS
- WOODEN WORKTOP
- DOCUMENT HOLDER
- 100% RETRACTABLE DRAWERS
- BALL-BEARING DRAWERS
- POWDER COATING
- FRONT CENTRALIZED SAFETY-LOCK
- CAN HOLDER
- PAPER ROLL HOLDER
- TRASH CAN
- 4 RUBBER CASTERS (Ø 125MM-50MM) 2 SWIVEL CASTERS WITH BRAKE AND 2 FIXED
- NET WEIGHT: 155KG
- MAXIMUM LOAD: 400KG
- DRAWERS LOADABLE UP TO 40KG
- DIMENSIONS IN MM: W 1215 X D 740 X H 950
- AVAILABLE IN: BLACK RAL 9004



FOLDING KEY

CAN HOLDER

INCLUDING PAPER ROLL HOLDER

4 EXTRA LARGE WHEELS Ø125MM, WHEREOF 2 CASTERS WITH ROLLING AND TURNING BRAKE

GARBAGE BIN

FRONT CENTRALIZED SAFETY LOCK

SAFETY DRAWER RELEASE SYSTEM, NO MECHANISM IN THE HANDLE

SAFETY DRAWER BLOCKING SYSTEM, PROTECTION AGAINST TIPPING OVER

DIMENSIONS

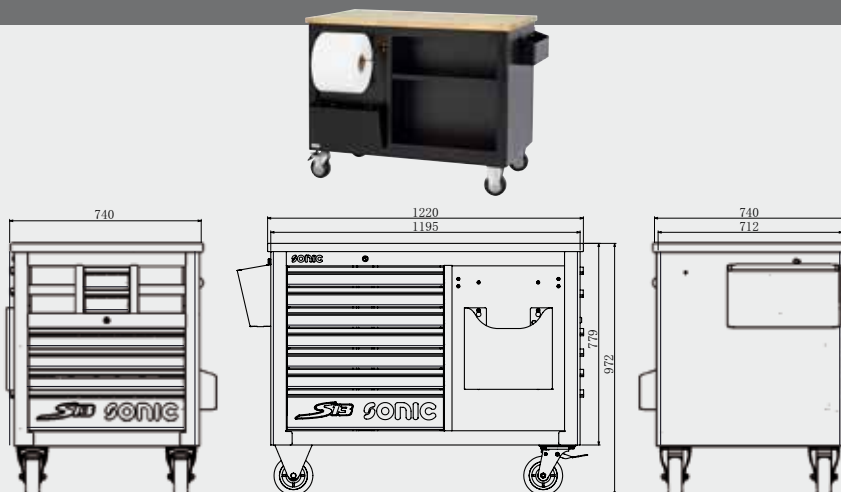

BUILD YOUR OWN UNIQUE S13 TOOL BOX

575 X 370MM

1/3

1/3

1/3

190 X 370MM

190 X 370MM

190 X 370MM

FOAM SYSTEM DRAWER

S14 tool box

THE SONIC S14 IS A TOOL BOX WITH A WOODEN TOPBLADE. THE S14 IS EQUIPPED WITH 18 DRAWERS WITH THE LATEST AUTO RETURN BALL BEARING SLIDES. THE TOOL BOX IS PROVIDED WITH A POWDER COATING EXTERIOR WHICH IS AVAILABLE IN BLACK COLOR.

02

ART. NO. 47307118

MAIN FEATURES

- IN TOTAL 18 DRAWERS;
- 8 SHALLOW DRAWERS (DIM. 740 X 575 X 65MM)
- 8 SHALLOW DRAWERS (DIM. 370 X 575 X 65MM)
- 1 DEEP DRAWER (DIM. 740 X 575 X 145MM)
- 1 DEEP DRAWER (DIM. 370 X 575 X 145MM)
- SIDE HANDLE
- TORSION RESISTANT THROUGH PROFILE CONSTRUCTION AT THE 4 CORNERS
- DRAWER BLOCKING SYSTEM AS PROTECTION AGAINST TIPPING OVER
- WOODEN WORKTOP
- 100% RETRACTABLE DRAWERS
- POWDER COATING
- FRONT CENTRALIZED SAFETY-LOCK
- LOCK INCLUDING 2 FOLDING KEYS
- 2 INTEGRATED CAN HOLDER
- INTEGRATED PAPER ROLL HOLDER
- 4 RUBBER CASTERS (Ø 155MM-50MM) 2 SWIVEL CASTERS WITH BRAKE AND 2 FIXED CASTERS
- NET WEIGHT: 206KG
- MAXIMUM LOAD: 600KG
- DRAWERS LOADABLE UP TO 40KG
- DIMENSIONS IN MM: W 1460 X D 640 X H 1165
- AVAILABLE IN: BLACK RAL 9004



FOLDING KEY

100% RETRACTABLE DRAWERS WITH BALL BEARING SLIDES

INCLUDING PAPER ROLL HOLDER

PPU CASTERS, 2 FIXED, 2 SWIVEL WITH BRAKE (Ø 155MM - 50MM)

HEAVY DUTY HANDLE

2 CAN HOLDERS

WOODEN TOPBLADE

SAFETY DRAWER BLOCKING SYSTEM, PROTECTION AGAINST TIPPING OVER

DIMENSIONS



BUILD YOUR OWN UNIQUE S13 TOOL BOX



FOAM SYSTEM DRAWER

S15 tool box

THE SONIC S15 TOOL BOX IS A NEWLY DESIGNED TOOL BOX WITH TWO INTEGRATED CAN HOLDERS AND A PAPER ROLL HOLDER. THE BACKSIDE OF THE TOOL BOX IS DOUBLE WALLED AND THEREFOR EXTREMELY ROBUST AND STABLE. THE S15 TOOL BOX HAS A POWDER COATING EXTERIOR AND IS AVAILABLE IN BLACK.

ART. NO. 47338114

MAIN FEATURES

- IN TOTAL 14 DRAWERS;
- 7 SHALLOW DRAWERS (DIM. 740 X 575 X 75MM)
- 5 SHALLOW DRAWERS (DIM. 575 X 575 X 75MM)
- 1 DEEP DRAWER (DIM. 575 X 575 X 155MM)
- 1 DEEP AND WIDE DRAWER (DIM. 1435 X 575 X 195MM)
- SIDE HANDLE
- TORSION RESISTANT THROUGH PROFILE CONSTRUCTION AT THE 4 CORNERS
- DRAWER BLOCKING SYSTEM AS PROTECTION AGAINST TIPPING OVER
- STAINLESS STEEL WORKTOP
- 100% RETRACTABLE DRAWERS
- POWDER COATING
- FRONT CENTRALIZED SAFETY-LOCK
- LOCK INCLUDING 2 FOLDING KEYS
- 2 INTEGRATED CAN HOLDER
- INTEGRATED PAPER ROLL HOLDER
- 4 RUBBER CASTERS (Ø 155MM-50MM) 2 SWIVEL CASTERS WITH BRAKE AND 2 FIXED CASTERS
- MAXIMUM LOAD: 600KG
- DRAWERS LOADABLE UP TO 40KG
- DIMENSIONS IN MM: W 1665 X D 710 X H 1165
- AVAILABLE IN: BLACK RAL 9004



FOLDING KEY

2 CAN HOLDERS

INCLUDING PAPER ROLL HOLDER

4 RUBBER CASTERS (Ø 155MM-50MM) 2 SWIVEL CASTERS

SIDE HANDLE

FRONT CENTRALIZED SAFETY LOCK

SAFETY DRAWER RELEASE SYSTEM, NO MECHANISM IN THE HANDLE

SAFETY DRAWER BLOCKING SYSTEM, PROTECTION AGAINST TIPPING OVER

DIMENSIONS

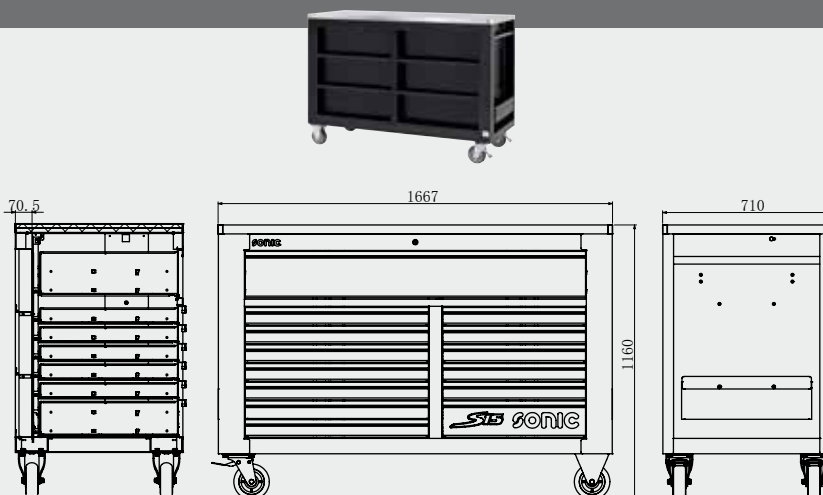

BUILD YOUR OWN UNIQUE S15 TOOL BOX

740 X 575MM
LEFT

575 X 575MM
RIGHT

FOAM SYSTEM DRAWER

ART. NO. 4732013

**SERVICE CART
3 DRAWERS BLACK**

MAIN FEATURES

- 3 DRAWERS WITH BALL BEARING SLIDES
- FRONT CENTRALIZED SAFETY LOCK
- POWDER COATING EXTERIOR
- 4 EXTRA LARGE WHEELS Ø125MM, WHEREOF 2 CASTER WITH ROLLING AND TURNING BRAKE

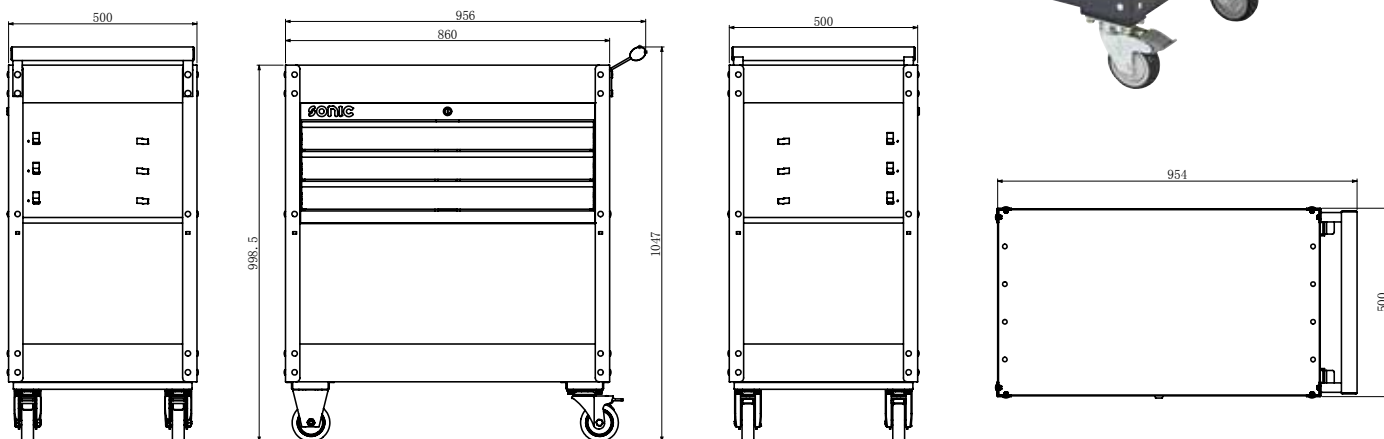

ART. NO. 4732110

SERVICE CART BLACK

MAIN FEATURES

- POWDER COATING EXTERIOR
- 4 EXTRA LARGE WHEELS Ø125MM, WHEREOF 2 CASTER WITH ROLLING AND TURNING BRAKE

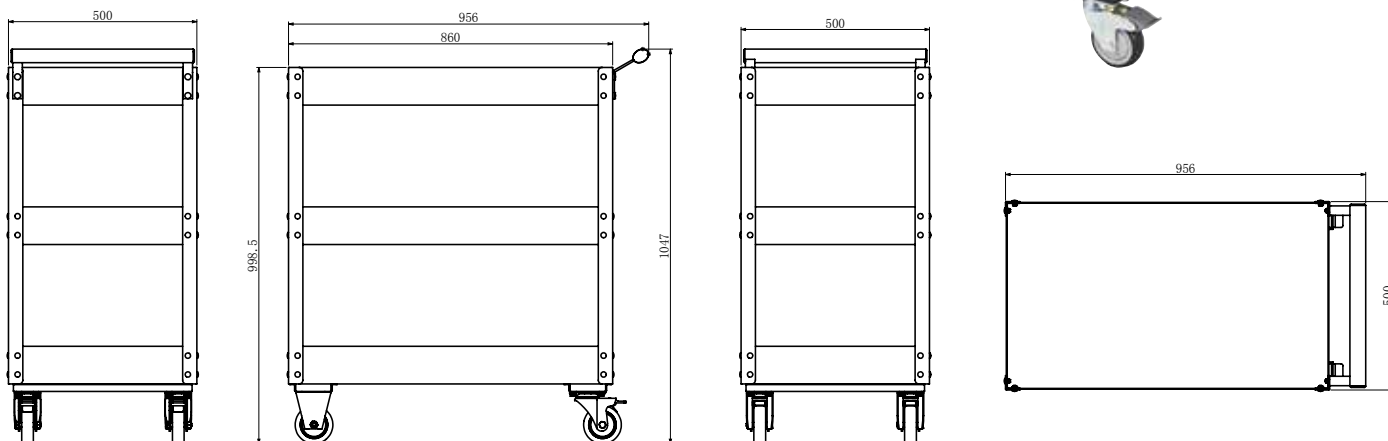

ART. NO. 4730414



MAIN FEATURES

- 4 DRAWERS WITH BALL BEARING SLIDES
- FRONT CENTRALIZED SAFETY LOCK
- 100% RETRACTABLE DRAWERS
- POWDER COATING EXTERIOR
- WEIGHT 11.5 KG
- RAL 7011

ART. NO. 4730224



MAIN FEATURES

- STAINLESS STEEL TOPBLADE
- FRONT CENTRALIZED SAFETY LOCK
- 100% RETRACTABLE DRAWERS
- AUTO RETURN BALL BEARING SLIDES
- OVERALL WEIGHT 39KG.
- MEASUREMENTS: L859 X W532 X H464MM
- RAL 7011

ART. NO. 4733014



MAIN FEATURES

- STAINLESS STEEL TOPBLADE
- FRONT CENTRALIZED SAFETY LOCK
- 100% RETRACTABLE DRAWERS
- AUTO RETURN BALL BEARING SLIDES
- OVERALL WEIGHT 46KG.
- MEASUREMENTS: L859 X W532 X H643MM
- RAL 7011

ART. NO. 4730415



MAIN FEATURES

- NO DIVIDER IN UPPER TRAY
- SHEET THICKNESS COVER 0,6MM, SHEET THICKNESS BOX 0,55MM
- PIANO HINGED COVER
- POWDER COATING EXTERIOR
- PRINT 'SONIC' IN BOTH LOWER TRAYS IN THE LEFT CORNER OF THE LONG SIDES
- INDIVIDUALLY PACKED IN A CARTON
- MEASUREMENTS: L565 X W200 X H200 MM
- RAL 9017

DIMENSIONS

SERVICE TOPBOX 4 DRAWERS



202 X 472MM

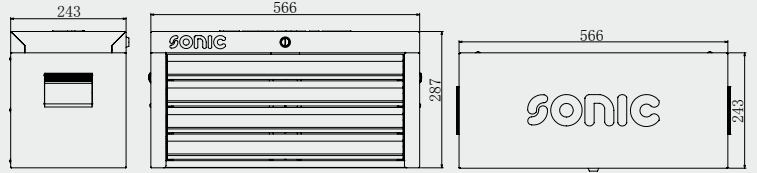

DIMENSIONS

EMPTY TOPBOX S9 4 DRAWERS



ART. NR. 4733210

575 X 370MM

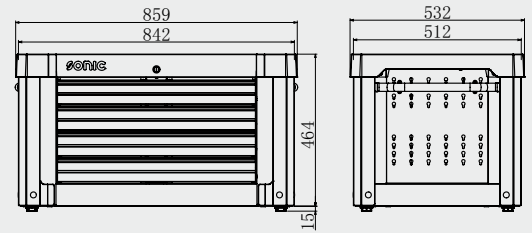

DIMENSIONS

EMPTY TOPBOX TROLLEY 4 DRAWERS



575 X 370MM

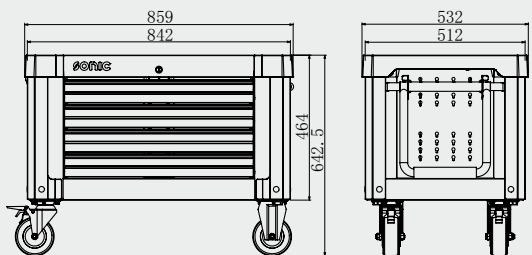

TOOLBOX 5 TRAYS



ART. NO. 47504 (MADE IN EU)

EMPTY SUITCASE L

EMPTY SUITCASE L

TOOL CASE WITH 48 ELASTICATED TOOL HOLDERS AND A BOTTOM TRAY FOR SUBDIVISION. FEATURES 10 TOOL HOLDERS IN THE TRAY COVER AND AN ASSORTMENT OF 3 INSERTS WITHIN THE TRAY ITSELF. IN THE TOOL CASE THERE IS A DOUBLE-SIDED TOOL PANEL WITH 24+14 TOOL HOLDERS.

MAIN FEATURES

- MEASUREMENTS: 360 X 475 X 200MM
- WEIGHT: 5KG
- LOAD CAPACITY: 25KG
- MATERIAL: ABS-HARD SHELL CASE, PROTECTS CASE AND CONTENT
- WITH GAS SPRINGS
- COLOUR: ALUMINUM/BLACK
- 2 CYLINDER KEY-LOCKS INTEGRATED IN FRAME



02

ART. NO. 47502 (MADE IN EU)

EMPTY SUITCASE XL

EMPTY SUITCASE XL

TOOL CASE WITH 78 ELASTICATED TOOL HOLDERS AND A BOTTOM TRAY FOR SUBDIVISION. FEATURES 11 TOOL HOLDERS IN THE TRAY COVER AND 2 INSERTS WITHIN THE TRAY ITSELF. IN THE TOOL CASE THERE IS A DOUBLE-SIDED TOOL PANEL WITH 28+17 TOOL HOLDERS PLUS A DOCUMENT HOLDER.

MAIN FEATURES

- MEASUREMENTS: 410 X 485 X 215MM
- WEIGHT: 6KG
- LOAD CAPACITY: 25KG
- MATERIAL: ABS-HARD SHELL CASE, PROTECTS CASE AND CONTENT
- WITH GAS SPRINGS
- COLOUR: ALUMINUM/BLACK
- 2 CYLINDER KEY-LOCKS INTEGRATED IN FRAME



ART. NO. 47503 (MADE IN EU)

SUITCASE TROLLEY XL

SUITCASE TROLLEY XL WITH RETRACTABLE HANDLE

ROLLING TOOL CASE WITH 79 ELASTICATED TOOL HOLDERS AND A BOTTOM TRAY FOR SUBDIVISION. FEATURES 11 TOOL HOLDERS IN THE TRAY COVER AND AN ASSORTMENT OF 5 INSERTS WITHIN THE TRAY ITSELF. IN THE TOOL CASE THERE IS A DOUBLE-SIDED TOOL PANEL WITH 28+17 TOOL HOLDERS PLUS A FURTHER SINGLE-SIDED PANEL WITH 23 TOOL HOLDERS PLUS A DOCUMENT HOLDER.

MAIN FEATURES

- MEASUREMENTS: 410 X 485 X 250MM
- WEIGHT: 6,5KG
- LOAD CAPACITY: 25KG
- MATERIAL: ABS-HARD SHELL CASE, PROTECTS CASE AND CONTENT
- WITH GAS SPRINGS
- COLOUR: ALUMINUM/BLACK
- 2 CYLINDER KEY-LOCKS INTEGRATED IN FRAME



SONIC WORK STATION THE PERFECT PORTABLE, MODULAR WORKSTATION, CONSISTING OF 4 MODULES



1



Extra large wheels

2



Removable
magnetic kickboard

3



100%
retractable drawers

4

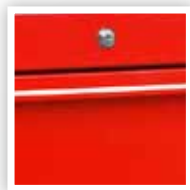

Front
centralized locks

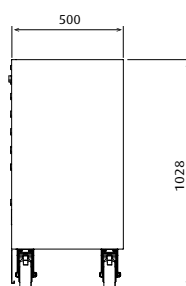
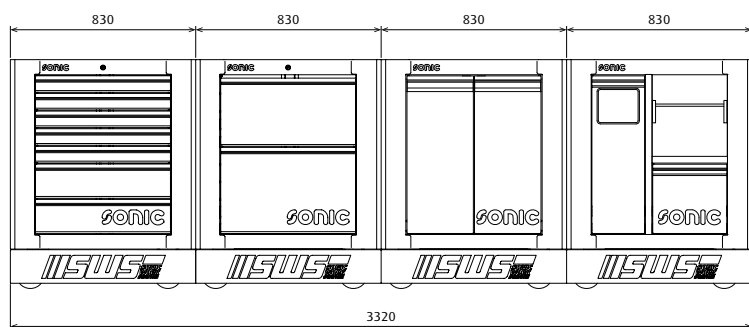

ART. NO. 4732210 BLACK

ART. NO. 4732220 RED



Rubber antistatic cover top



6



Double door
locker with 1
adjustable shelf

7



Integrated waste
paper compartment

8

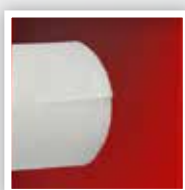

Integrated paper
roll holder

9



Extra storage
compartment

THE PERFECT PORTABLE, MODULAR WORKSTATION



ART. NO. 47458
ART. NO. 47472

ART. NO. 47457
ART. NO. 47471

SWS TOOL BOX 7 DRAWERS

MAIN FEATURES:

- 7 DRAWERS:
- 5 SHALLOW DRAWERS
- 2 DEEP DRAWERS
- 100% RETRACTABLE DRAWERS
- POWDER COATING EXTERIOR
- FRONT CENTRALIZED LOCK
- FOLDING KEY
- RUBBER ANTISTATIC COVER
- 4 EXTRA LARGE WHEELS Ø125MM, WHEREOF 2 CASTERS WITH ROLLING AND TURNING BRAKE
- OVERALL WEIGHT 78KG
- STATIC LOAD CAPACITY: 400KG
- DRAWER CAPACITY: 40KG

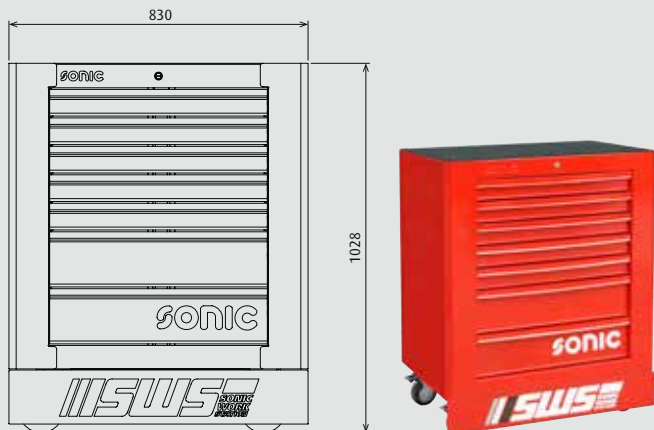

SWS TOOL BOX WITH 2 DRAWERS

MAIN FEATURES:

- 2 DRAWERS:
- 1 DRAWER 270 HIGH
- 1 DRAWER 380 HIGH
- 100% RETRACTABLE DRAWERS
- POWDER COATING EXTERIOR
- FRONT CENTRALIZED LOCK
- FOLDING KEY
- RUBBER ANTISTATIC COVER
- 4 EXTRA LARGE WHEELS Ø125MM, WHEREOF 2 CASTERS WITH ROLLING AND TURNING BRAKE
- OVERALL WEIGHT 64KG
- STATIC LOAD CAPACITY: 400KG
- DRAWER CAPACITY: 40KG

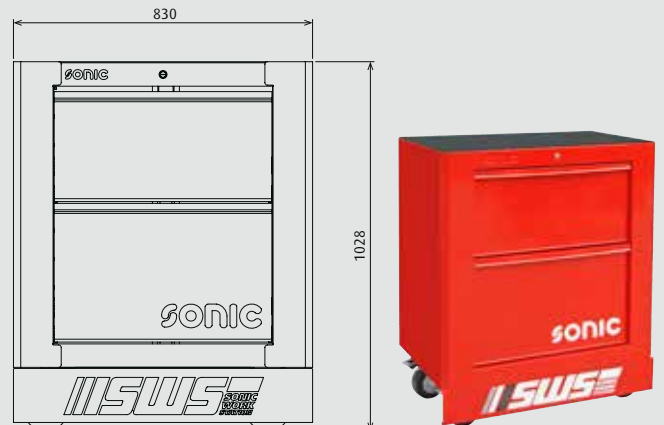

N, CONSISTING OF 4 MODULES



02



ART. NO. 47455
ART. NO. 47469

ART. NO. 47456
ART. NO. 47470

SWS TOOL BOX WITH 2 DOORS

MAIN FEATURES:

- 2 DOORS
- 1 ADJUSTABLE SHELF
- POWDER COATING EXTERIOR
- RUBBER ANTISTATIC COVER
- 4 EXTRA LARGE WHEELS Ø125MM, WHEREOF 2 CASTERS WITH ROLLING AND TURNING BRAKE
- OVERALL WEIGHT 52KG
- STATIC LOAD CAPACITY: 400KG

SWS RECYCLE CABINET

MAIN FEATURES:

- INTEGRATED WASTE PAPER COMPARTMENT
- INTEGRATED PAPER ROLL HOLDER
- EXTRA STORAGE COMPARTMENT
- POWDER COATING EXTERIOR
- RUBBER ANTISTATIC COVER
- 4 EXTRA LARGE WHEELS Ø125MM, WHEREOF 2 CASTERS WITH ROLLING AND TURNING BRAKE
- OVERALL WEIGHT 60KG
- STATIC LOAD CAPACITY: 400KG



IMPROVE YOUR IMAGE, PRODUCTIVITY & EFFICIENCY



Heavy duty
ball bearing slides.



100% retractable
drawers.



Stainless steel
work surface.



Steel panel
for tool storage.



THE MASTER WORKSTATION CAN BE PURCHASED IN THREE DIFFERENT WAYS; A LEFT UNIT, A RIGHT UNIT OR TOGETHER AS A COMPLETE SETUP. THE COMPLETE SETUP CONSISTS OF 42 DRAWERS WHICH ARE 100% RETRACTABLE AND PROVIDED WITH HEAVY DUTY BALL BEARING SLIDES. THE MWS IS A SELF SUPPORTING STRUCTURE, WALLS ARE NO LONGER NEEDED TO INSTALL THE MWS WHEREVER YOU LIKE, NO RESTRICTIONS. THE MWS IS PROVIDED WITH 2 USB, - 2 LAN, - AND 2 AIR CONNECTORS AND ELECTRONIC CONNECTORS WITH OVERLOAD PROTECTION.

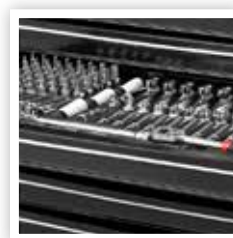

Compatible for SFS.

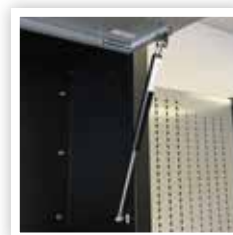

Cupboard with gas spring.



Front centralized locks.

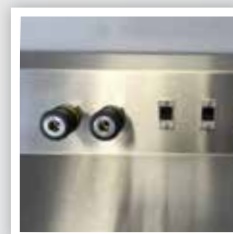

2 USB connectors.
2 LAN connectors.
2 AIR connectors.



IMPROVE YOUR IMAGE, PRODUCTIVITY & EFFICIENCY



MASTER WORK STATION, THE BALANCED STORAGE AND WORK

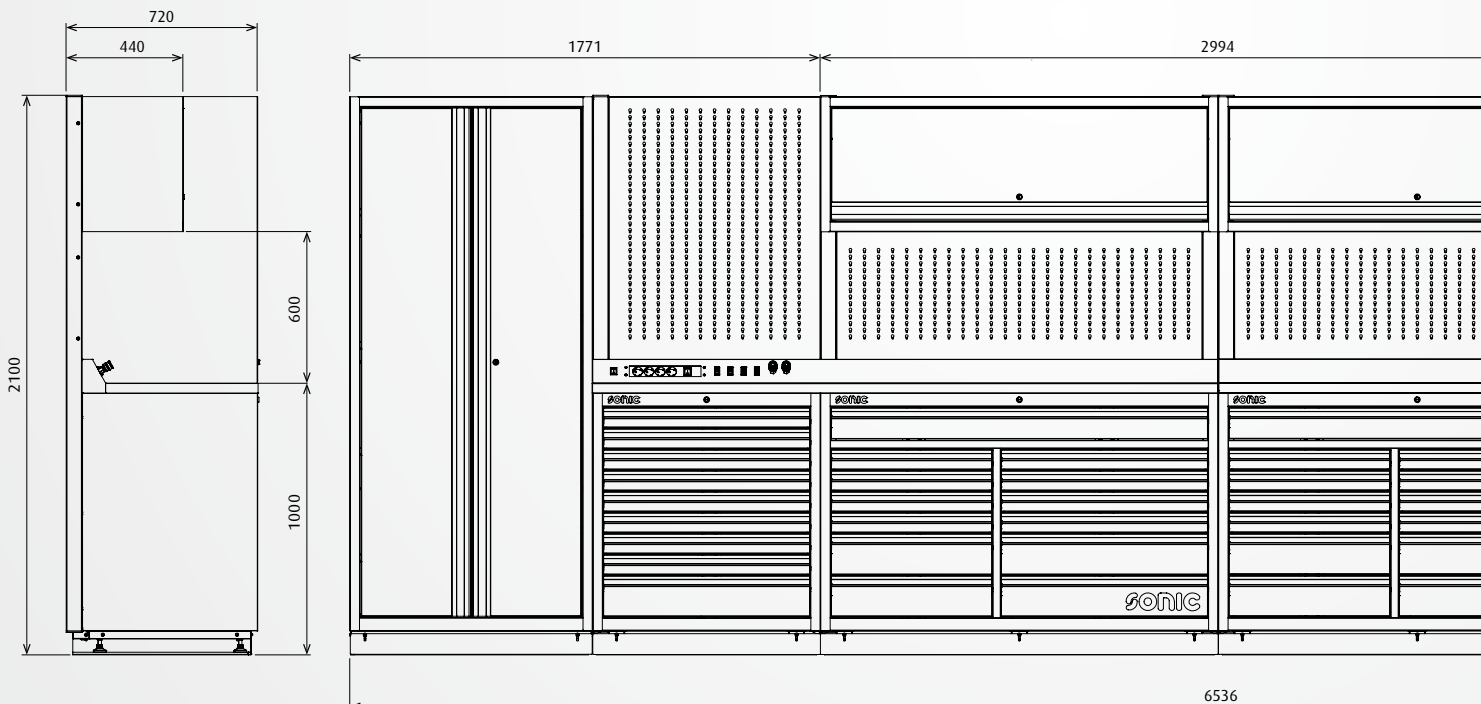

ART. NO. 4730670

ART. NO. 4732355 RIGHT

ART. NO. 4731355 LEFT



SPACE, TO MAXIMIZE YOUR WORK FLOW AND PRODUCTIVITY

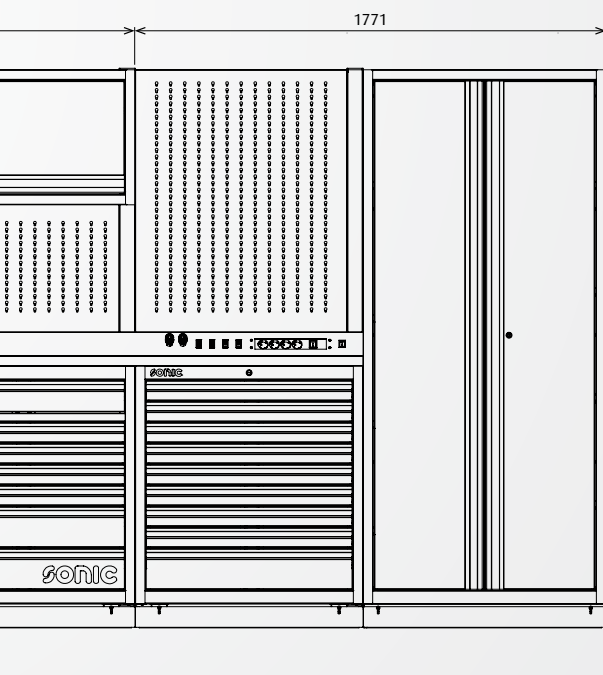

DRAWERS' INSIDE DIMENSION LEFT OR RIGHT
TOTAL 44 DRAWERS, (LEFT 22 AND RIGHT 22)

1X FULL DEEP DRAWER L1390 X D578 X H102MM	
4X DRAWER L579 X D578 X H67MM	12X DRAWER L750 X D578 X H67MM
2X DRAWER L579 X D578 X H146MM	3X DRAWER L750 X D578 X H146MM

FOR OUR HOOKS SEE PAGE 45



GET ORGANIZED, BE EFFICIENT, THE NEW ULTIMATE SONIC WORK SPACE



Heavy duty
ball bearing slides.



100% retractable
drawers.



Stainless steel
work surface.



Steel panel
for tool storage.



CREATE THE ULTIMATE AND FLEXIBLE WORKING AREA WITH THE MODULAR STORAGE SYSTEM(MMS) FROM SONIC. THIS MODULAR SYSTEM IS EASILY TO ASSEMBLE, TO CONSTRUCT AND TO EXTEND. THIS SELF SUPPORTING SYSTEM IS COMPATIBLE TO ALMOST EVERY WORKING AREA. THE MSS SYSTEM IS EASILY TO COMBINE WITH THE SONIC FOAM SYSTEM.

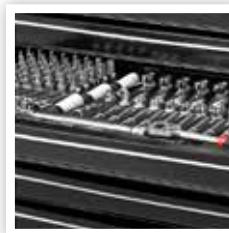

Compatible
for SFS.



Cupboard with
gas spring.



Front centralized locks.



22x drawers with
capacity 40Kg.

SELF SUPPORTING STRUCTURE, WALLS NO LONGER NEEDED
INSTALL THE MSS WHEREVER YOU LIKE, NO RESTRICTIONS

ART. NO. 4731520 WOODEN TOP BLADE

ART. NO. 4731820 STAINLESS STEEL TOP BLADE

MEASUREMENTS: L3100 X D2255 X H2000MM



- ART. NO. 47280
26" CABINET NO TOP BLADE
- ART. NO. 4731308
26" CABINET WOODEN TOP BLADE
- ART. NO. 4731608
26" CABINET STAINLESS STEEL TOP BLADE

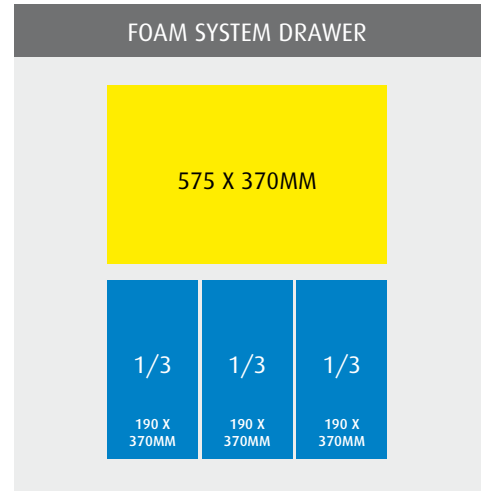
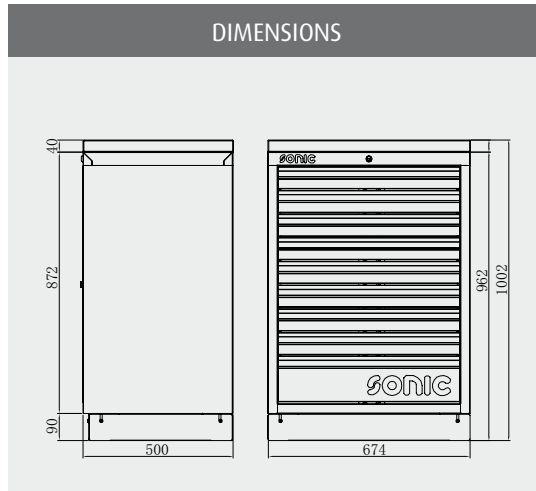

- ART. NO. 47647
26" CABINET 5 DRAWERS NO TOP BLADE
- ART. NO. 4731318
26" CABINET 5 DRAWERS WOODEN TOP BLADE
- ART. NO. 4731618
26" CABINET 5 DRAWERS STAINLESS STEEL TOP BLADE

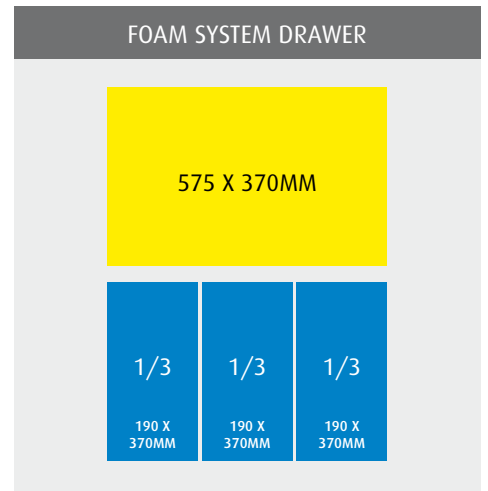
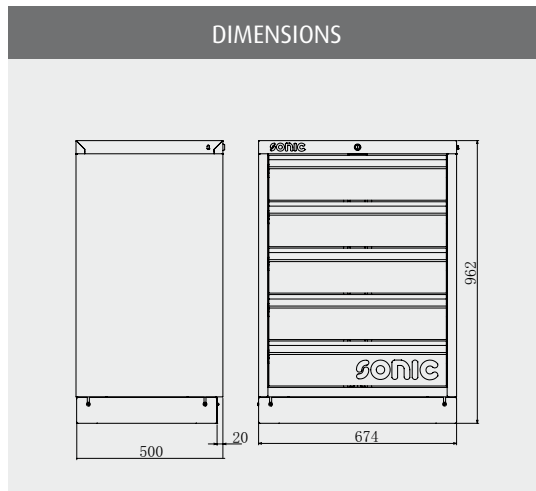

- ART. NO. 47640
26" CABINET 5 DRAWERS NO TOP BLADE
- ART. NO. 4731315
26" CABINET 5 DRAWERS WOODEN TOP BLADE
- ART. NO. 4731615
26" CABINET 5 DRAWERS STAINLESS STEEL TOP BLADE

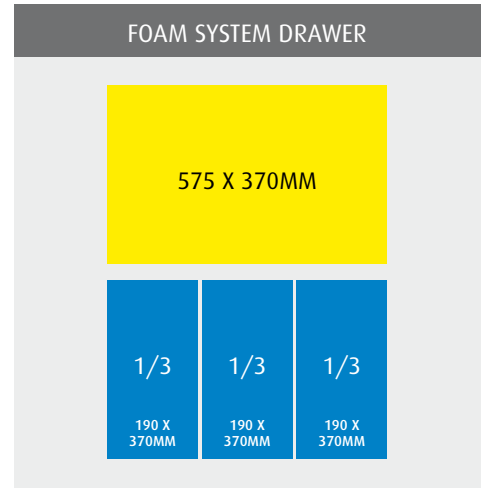
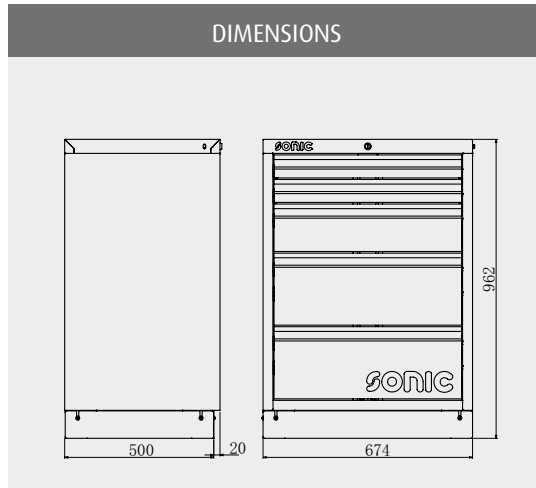

- ART. NO. 47288
26" CLOSET NO TOP BLADE
- ART. NO. 4731309
26" CLOSET WOODEN TOP BLADE
- ART. NO. 4731609
26" CLOSET STAINLESS STEEL TOP BLADE

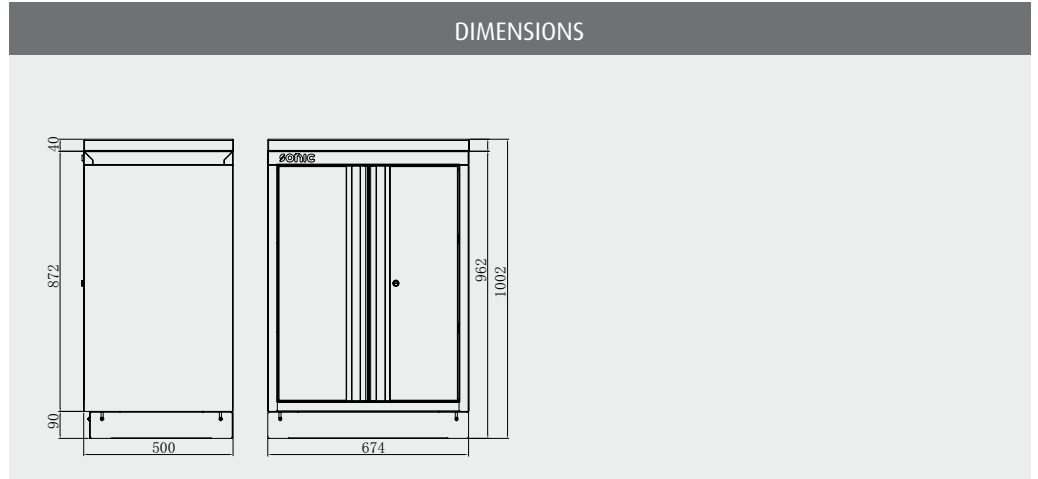



ART. NO. 47308
26" CABINET WITH DOOR NO TOP BLADE
ART. NO. 4731310
26" CABINET WITH DOOR WOODEN TOP BLADE
ART. NO. 4731610
26" CABINET WITH DOOR STAINLESS STEEL T. B.



ART. NO. 47431
26" TRASH CAN CLOSET NO TOP BLADE
ART. NO. 4731316
26" TRASH CAN CLOSET WOODEN TOP BLADE
ART. NO. 4731616
26" TRASH CAN CLOSET STAINLESS STEEL
TOP BLADE



ART. NO. 47450
26" RECYCLE BIN
ART. NO. 4731312
26" RECYCLE BIN WOODEN TOP BLADE
ART. NO. 4731612
26" RECYCLE BIN STAINLESS STEEL TOP BLADE



ART. NO. 47432
26" CLOSET WITH SINK NO TOP
ART. NO. 4731317
26" CLOSET WITH SINK WOODEN
ART. NO. 4731617
26" CLOSET WITH SINK STAINLESS STEEL T. B.

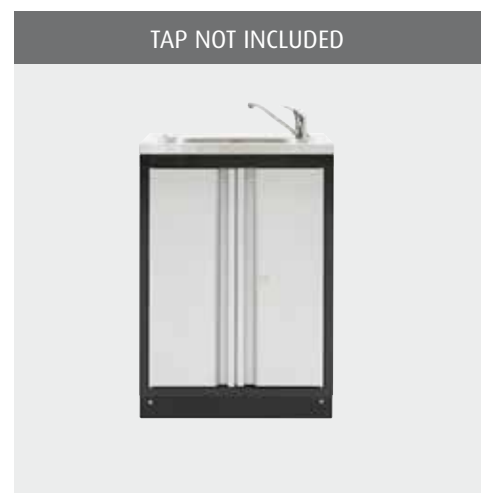
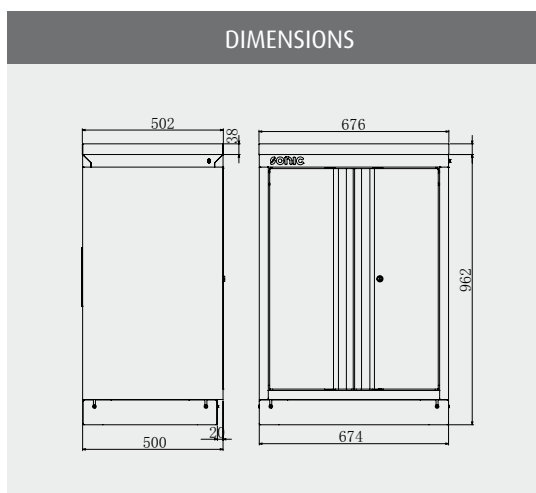
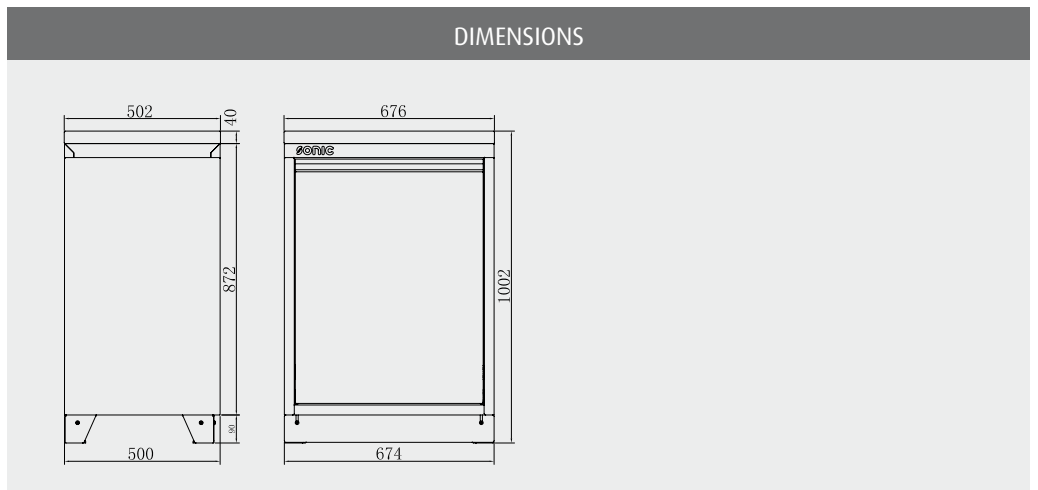
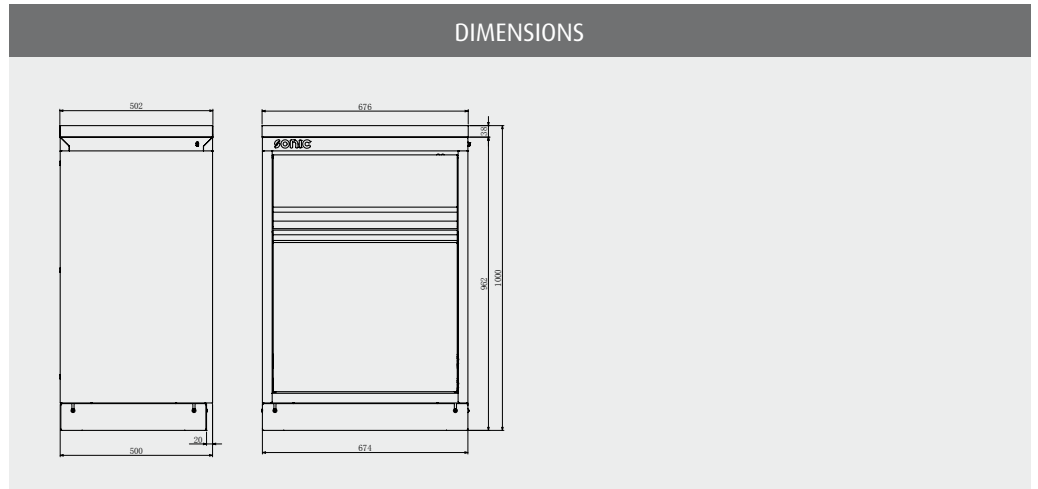
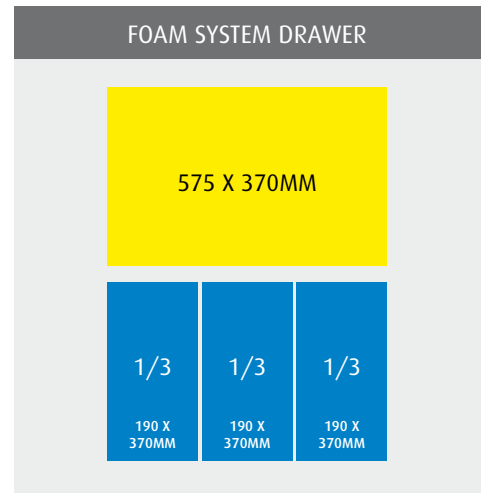
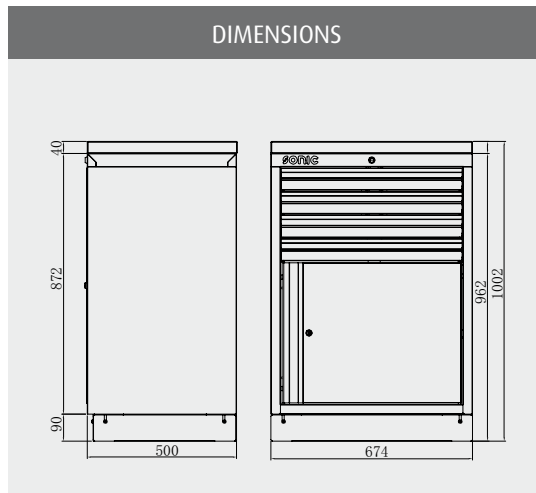



ART. NO. 47451
26" PORTABLE TOOL BOX 7 DRAWERS

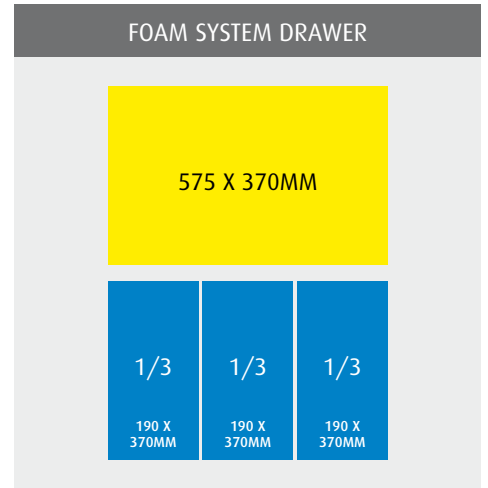
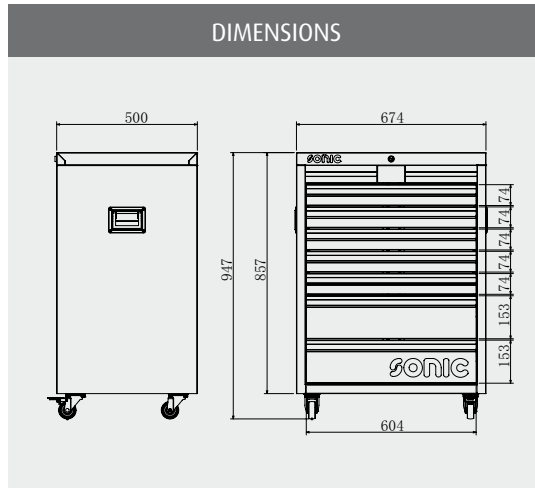

ART. NO. 4731311
26" CABINET WITH HANGER BOARD
WOODEN TOP BLADE

ART. NO. 4731611
26" CABINET WITH HANGER BOARD
STAINLESS STEEL TOP BLADE

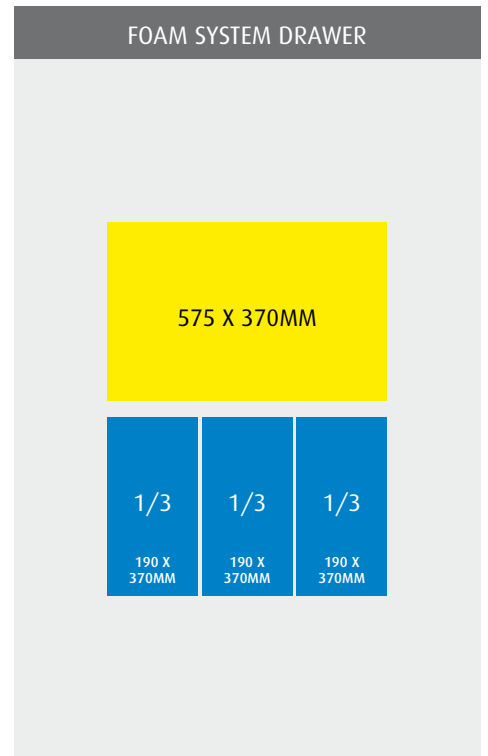
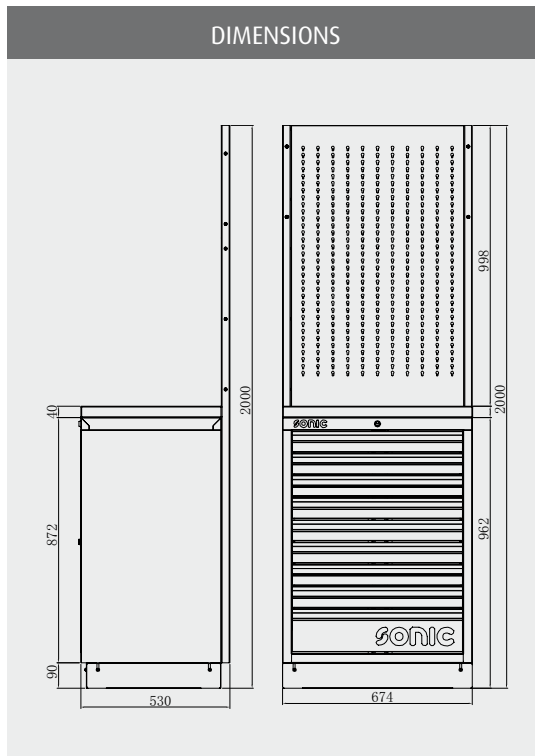

ART. NO. 47296
34" CABINET NO TOP BLADE

ART. NO. 4731407
34" CABINET WOODEN TOP BLADE

ART. NO. 4731707
34" CABINET STAINLESS STEEL TOP BLADE

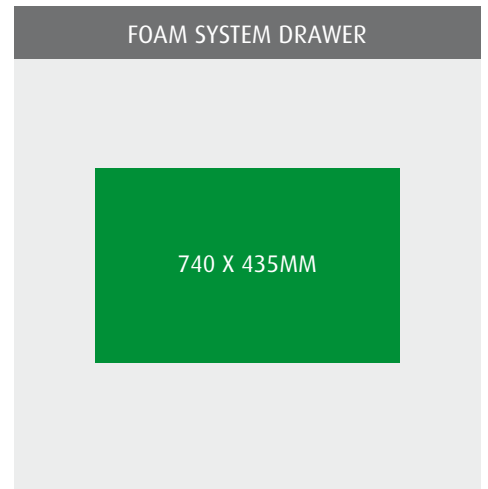
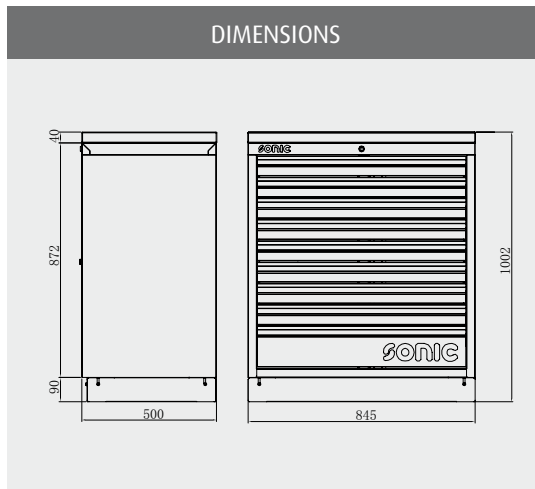



ART. NO. 47302
34" CLOSET NO TOP BLADE
ART. NO. 4731408
34" CLOSET WOODEN TOP BLADE
ART. NO. 4731708
34" CLOSET STAINLESS STEEL TOP BLADE

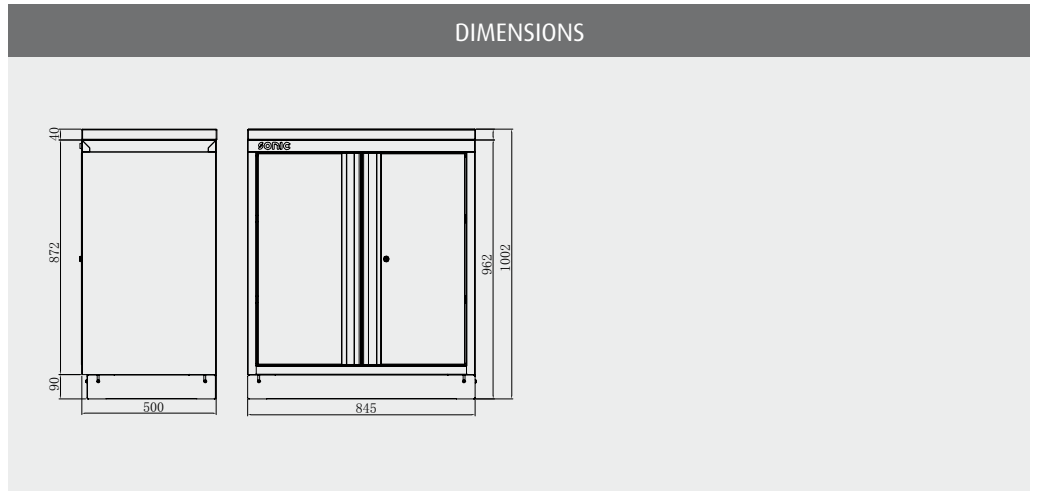

ART. NO. 47379
26" CLOSET NO TOP BLADE
ART. NO. 4731410
34" CABINET WITH DOOR WOODEN TOP BLADE
ART. NO. 4731710
34" CABINET WITH DOOR STAINLESS STEEL T. B.

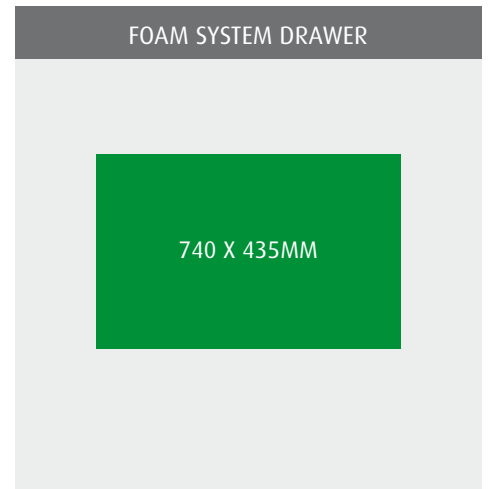
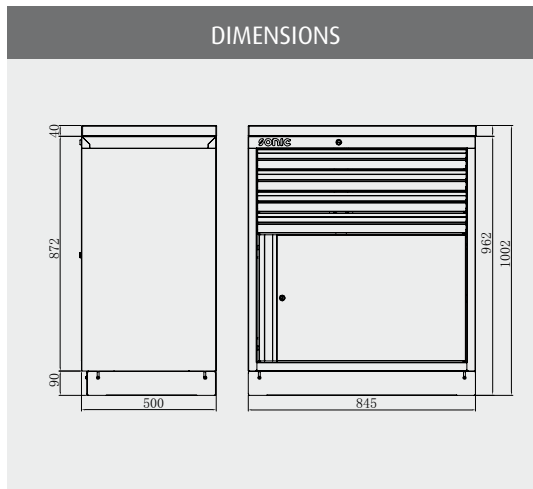

ART. NO. 47600
34" CLOSET FOR REELS NO TOP BLADE
ART. NO. 4731416
34" CLOSET FOR REELS WOODEN TOP BLADE
ART. NO. 4731618
34" CLOSET FOR REELS STAINLESS STEEL
TOP BLADE

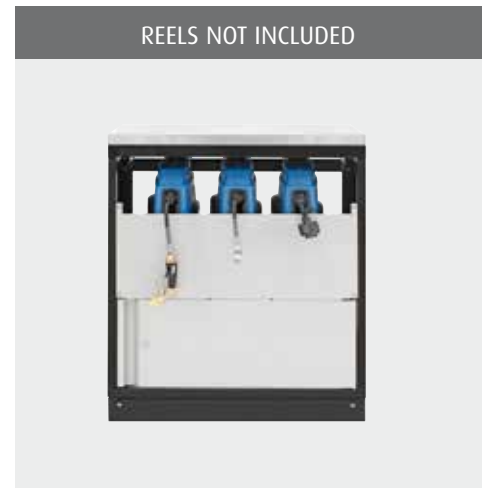
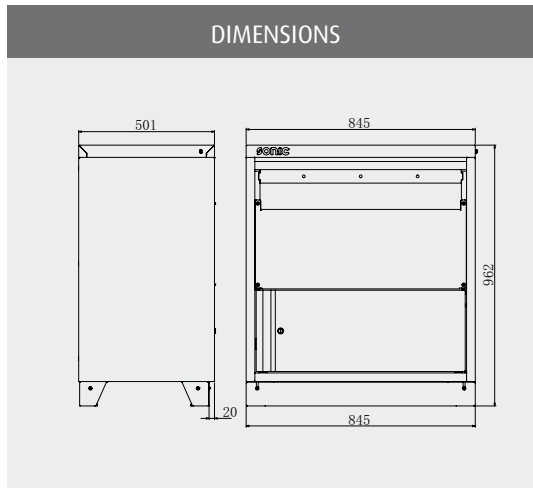

ART. NO. 47505
MSS 34" CORNER CLOSET NO TOP BLADE
ART. NO. 4731414
MSS 34" CORNER CLOSET WOODEN TOP BLADE
ART. NO. 4731714
34" CORNER CLOSET STAINLESS STEEL TOP BLADE

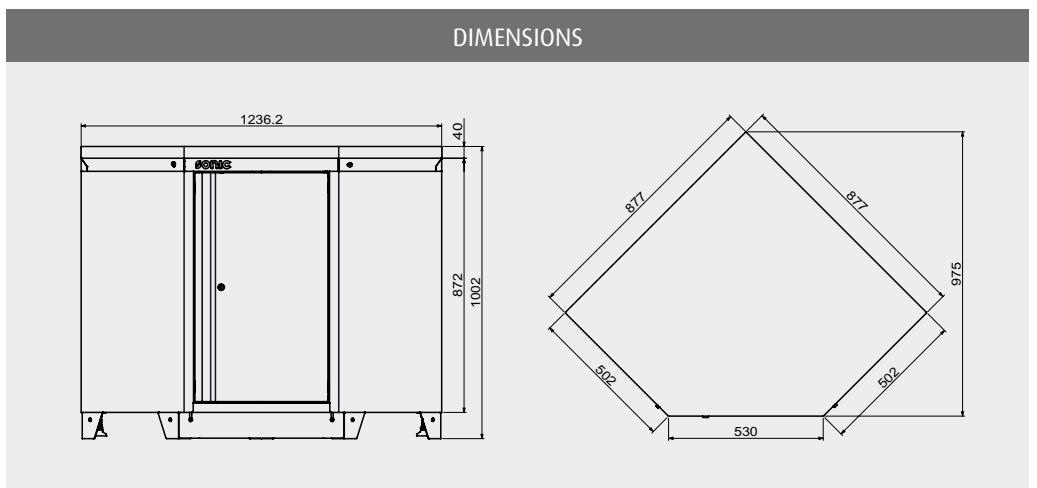



ART. NO. 4731409
34" CABINET WITH HANGER BOARD
WOODEN TOP BLADE

ART. NO. 4731709
34" CABINET WITH HANGER BOARD
STAINLESS STEEL TOP BLADE

DIMENSIONS

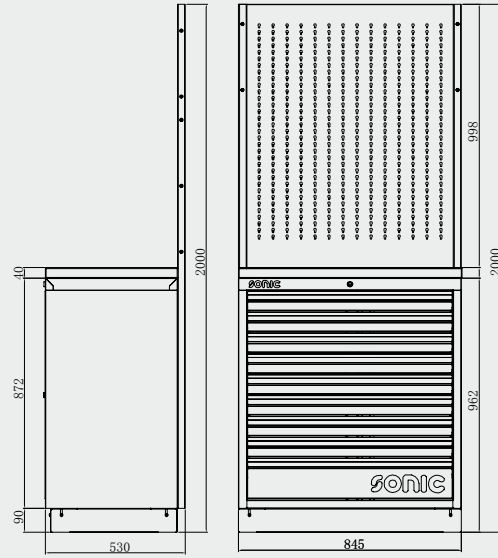

FOAM SYSTEM DRAWER



740 X 435MM



DIMENSIONS

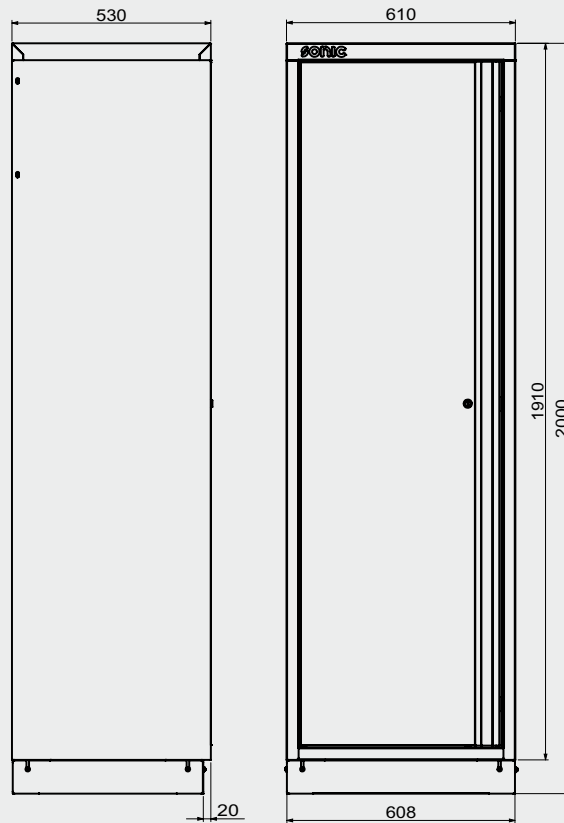

ART. NO. 47272 24" THE LOCKER
CONTAINS 5 SHELVES AND 1 WARDROBE BAR
MEASUREMENTS: L610 X D530 X H2000MM



ART. NO. 47433 36" DOUBLE DOOR LOCKER
THE LOCKER CONTAINS 4 SHELVES
MEASUREMENTS: L910 X D530 X H2000MM

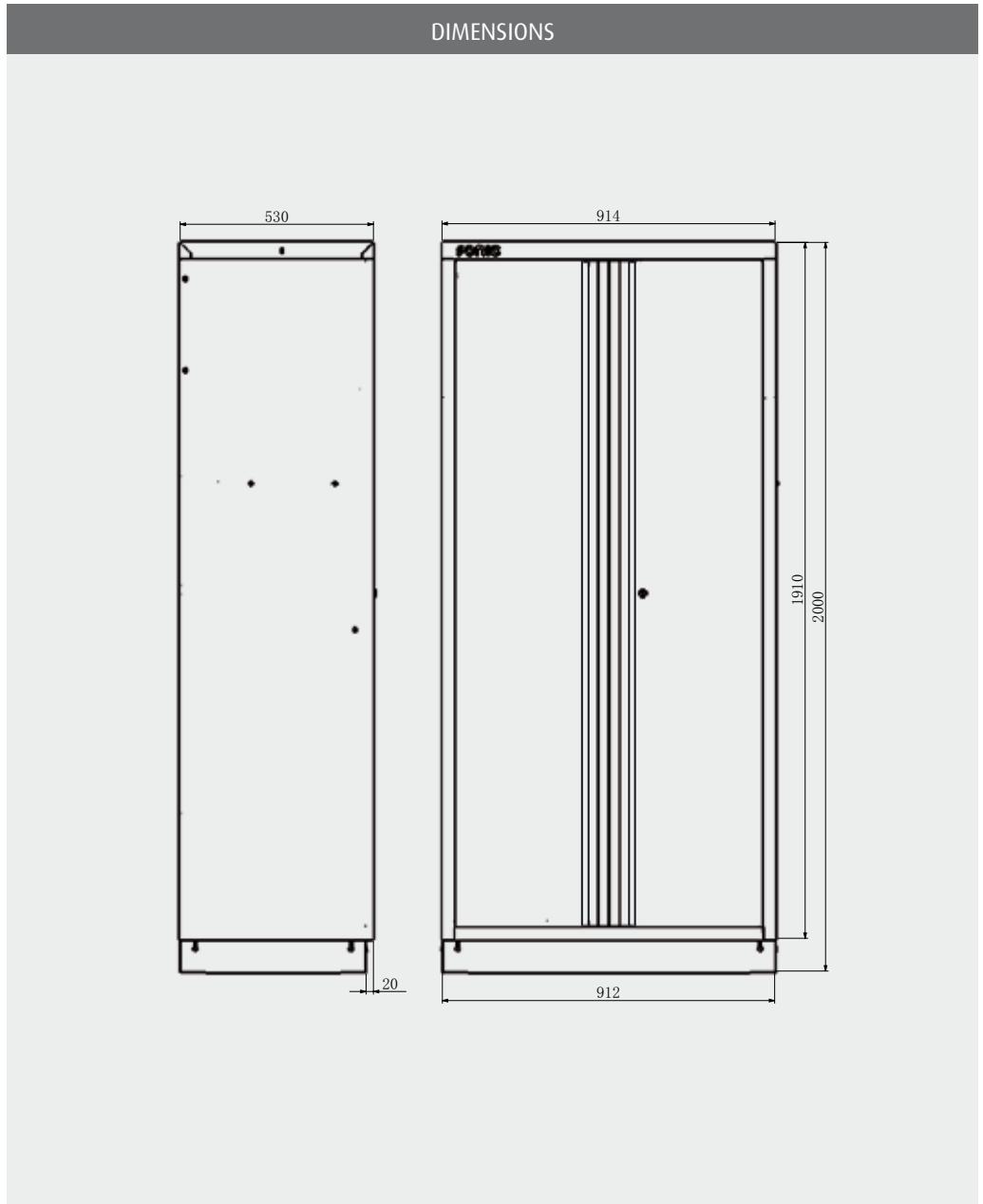

ART. NO. 47276
26" CUPBOARD L674 X D300 X H400MM
ART. NO. 47292
34" CUPBOARD L845 X D300 X H400MM

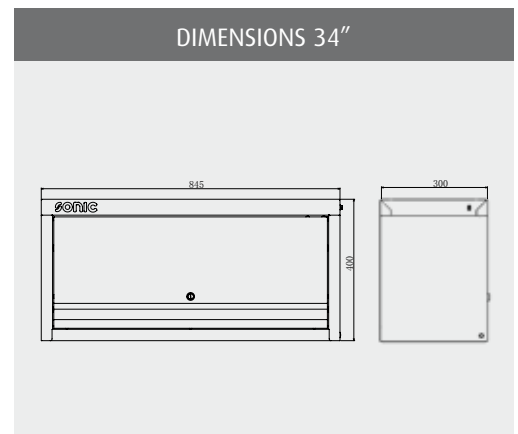
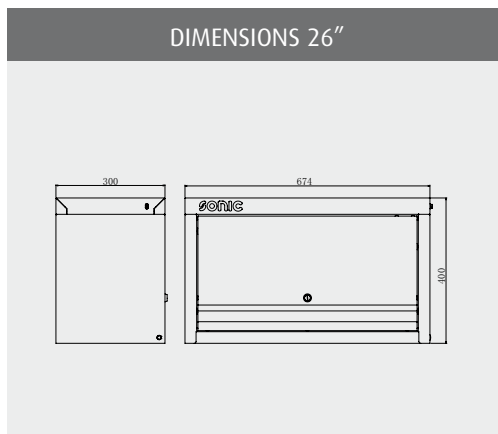

WOODEN TOP BLADE



- ART. NO. 47378 DIM.: L674 X D500 X H40MM
- ART. NO. 47382 DIM.: L845 X D500 X H40MM
- ART. NO. 47279 DIM.: L1348 X D500 X H40MM
- ART. NO. 47295 DIM.: L1690 X D500 X H40MM
- ART. NO. 47306 DIM.: L2193 X D500 X H40MM

STAINLESS STEEL TOP BLADE



- ART. NO. 47377 DIM.: L674 X D500 X H38MM
- ART. NO. 47381 DIM.: L845 X D500 X H38MM
- ART. NO. 47383 DIM.: L1348 X D500 X H38MM
- ART. NO. 47384 DIM.: L1690 X D500 X H38MM
- ART. NO. 47385 DIM.: L2193 X D500 X H38MM

STAINLESS STEEL TOP BLADE EXTRA DEEP



- ART. NO. 47447 DIM.: L1348 X D570 X H38MM
- ART. NO. 47448 DIM.: L1690 X D570 X H38MM
- ART. NO. 47449 DIM.: L2193 X D570 X H38MM

WORK PLATE FOR CLOSET



- ART. NO. 47544 WOODEN WORK PLATE FOR CLOSET 47505
- ART. NO. 47545 MSS STAINLESS STEEL WORK PLATE FOR CLOSET 47505

FULL HIGH HANGER BOARD

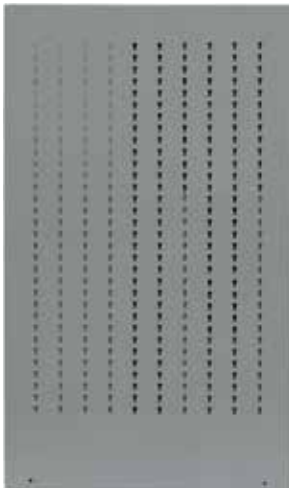

- ART. NO. 47376 26" FULL HIGH HANGER BOARD
- ART. NO. 47380 34" FULL HIGH HANGER BOARD

WIRE PIPE



- ART. NO. 47283 WIRE PIPE L60 X D30 X H1910MM
- ART. NO. 47284 WIRE PIPE L30 X D30 X H1910MM



ART. NO. 47415 MSS HOOK 50MML
ART. NO. 47290 MSS HOOK 90MML
ART. NO. 47291 MSS HOOK 150MML



ART. NO. 47416 MSS HOOK ROUND Ø40MM
ART. NO. 47417 MSS HOOK ROUND Ø60MM
ART. NO. 47418 MSS HOOK ROUND Ø80MM

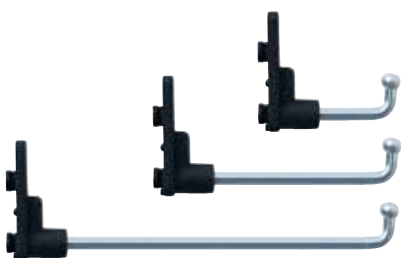

ART. NO. 47419 MSS HOOK 90° 50MML
ART. NO. 47420 MSS HOOK 90° 90MML
ART. NO. 47421 MSS HOOK 90° 150MML

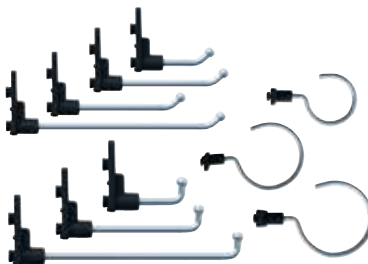

ART. NO. 47632 MSS HOOK SET 10-PCS



ART. NO. 47638 MSS PLIERS HOLDER



ART. NO. 47639 MSS SCREWDRIVER HOLDER



ART. NO. 4821519 TIE RAP HOLDER FOR MSS/MWS



ART. NO. 4821518 TIE RAP HOLDER FOR MSS/MWS; FILLED WITH TIE RAPS*

*TIE RAPS	
ART. NO.	CONTENTS
4821511	2 TIE RAP 3,6X140MML; 100 PIECES IN BAG (BLACK)
4821512	2 TIE RAP 3,6X180MML; 100 PIECES IN BAG (BLACK)
4821514	2 TIE RAP 4,8X220MML; 100 PIECES IN BAG (BLACK)
4821515	2 TIE RAP 4,8X280MML; 100 PIECES IN BAG (BLACK)
4821517	2 TIE RAP 4,8X370MML; 100 PIECES IN BAG (BLACK)

EMPTY TRAY, 5 COMPARTMENTS



ART. NO.	CONTENTS
4720101	EMPTY TRAY, 5 COMPARTMENTS
SIZE: 370 X 145 X 48	

EMPTY TRAY, 5 COMPARTMENTS



ART. NO.	CONTENTS
4720102	EMPTY TRAY, 5 COMPARTMENTS
SIZE: 370 X 145 X 48	

EMPTY TRAY, 8 COMPARTMENTS



ART. NO.	CONTENTS
4720103	EMPTY TRAY, 8 COMPARTMENTS
SIZE: 370 X 290 X 48	

EMPTY TRAY, 12 COMPARTMENTS



ART. NO.	CONTENTS
4720104	EMPTY TRAY, 12 COMPARTMENTS
SIZE: 370 X 290 X 48	

EMPTY TRAY, 18 COMPARTMENTS



ART. NO.	CONTENTS
4720105	EMPTY TRAY, 18 COMPARTMENTS
SIZE: 370 X 290 X 48	

GET ORGANIZED, BE EFFICIENT, THE NEW ULTIMATE SONIC WORK SPACE



ART. NO. 4731819
DEEP STAINLESS STEEL TOP BLADE
MEASUREMENTS: L3107 X D600 X H2000MM



EXTRA DEEP STAINLESS STEEL TOP BLADE



ART. NO. 4730281 WOODEN TOP BLADE
ART. NO. 4731281 STAINLESS STEEL TOP BLADE
MEASUREMENTS: L2803 X D530 X H2000MM

DRAWERS' INSIDE DIMENSION
TOTAL 13 DRAWERS

FOR OUR HOOKS SEE PAGE 45



<p>4X DRAWER L575 X D370 X H60MM</p>	<p>8X DRAWER L740 X D435 X H60MM</p>	<p>1X DRAWER L740 X D435 X H137MM</p>
--	--	---





ART. NO. 4731517 WOODEN TOP BLADE
ART. NO. 4731817 STAINLESS STEEL TOP BLADE
MEASUREMENTS: L2803 X D530 X H2000MM



ART. NO. 4731518 WOODEN TOP BLADE
ART. NO. 4731818 STAINLESS STEEL TOP BLADE
MEASUREMENTS: L2803 X D530 X H2000MM



ART. NO. 4730281 WOODEN TOP BLADE
ART. NO. 4731281 STAINLESS STEEL TOP BLADE
MEASUREMENTS: L2803 X D530 X H2000MM



ART. NO. 4731509 WOODEN TOP BLADE
ART. NO. 4731809 STAINLESS STEEL TOP BLADE
MEASUREMENTS: L2803 X D530 X H2000MM



ART. NO. 4731513 WOODEN TOP BLADE
ART. NO. 4731813 STAINLESS STEEL TOP BLADE
MEASUREMENTS: L2193 X D530 X H2000MM



ART. NO. 4731514 WOODEN TOP BLADE
ART. NO. 4731814 STAINLESS STEEL TOP BLADE
MEASUREMENTS: L2193 X D530 X H2000MM



ART. NO. 4731501 WOODEN TOP BLADE
ART. NO. 4731801 STAINLESS STEEL TOP BLADE
MEASUREMENTS: L2193 X D530 X H2000MM



ART. NO. 4731502 WOODEN TOP BLADE
ART. NO. 4731802 STAINLESS STEEL TOP BLADE
MEASUREMENTS: L2193 X D530 X H2000MM



ART. NO. 4731503 WOODEN TOP BLADE
ART. NO. 4731803 STAINLESS STEEL TOP BLADE
MEASUREMENTS: L2193 X D530 X H2000MM



ART. NO. 4731504 WOODEN TOP BLADE
ART. NO. 4731804 STAINLESS STEEL TOP BLADE
MEASUREMENTS: L2193 X D530 X H2000MM



ART. NO. 4731515 WOODEN TOP BLADE
ART. NO. 4731815 STAINLESS STEEL TOP BLADE
MEASUREMENTS: L2193 X D500 X H1002MM



ART. NO. 4731516 WOODEN TOP BLADE
ART. NO. 4731816 STAINLESS STEEL TOP BLADE
MEASUREMENTS: L2193 X D500 X H1002MM



ART. NO. 4731505 WOODEN TOP BLADE
ART. NO. 4731805 STAINLESS STEEL TOP BLADE
MEASUREMENTS: L2193 X D500 X H1002MM



ART. NO. 4731506 WOODEN TOP BLADE
ART. NO. 4731806 STAINLESS STEEL TOP BLADE
MEASUREMENTS: L2193 X D500 X H1002MM



ART. NO. 4731507 WOODEN TOP BLADE
ART. NO. 4731807 STAINLESS STEEL TOP BLADE
MEASUREMENTS: L2193 X D500 X H1002MM



ART. NO. 4731508 WOODEN TOP BLADE
ART. NO. 4731808 STAINLESS STEEL TOP BLADE
MEASUREMENTS: L2193 X D500 X H1002MM

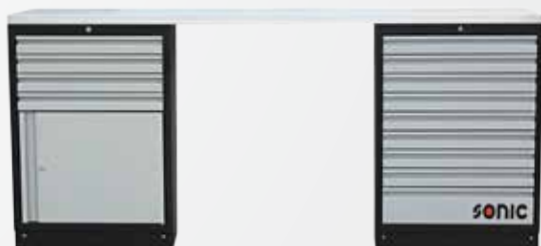

ART. NO. 4731510 WOODEN TOP BLADE
ART. NO. 4731810 STAINLESS STEEL TOP BLADE
MEASUREMENTS: L2193 X D500 X H1002MM



ART. NO. 4731511 WOODEN TOP BLADE
ART. NO. 4731811 STAINLESS STEEL TOP BLADE
MEASUREMENTS: L2193 X D530 X H2000MM

THE NEW ULTIMATE SONIC WORK SPACE



ART. NR. 4731415 WOODEN TOP BLADE
ART. NR. 4731715 STAINLESS STEEL TOP BLADE
MEASUREMENTS: L935.5 X D530 X H2000MM



ART. NO. 4730230 WOODEN TOP BLADE
ART. NO. 4731230 STAINLESS STEEL TOP BLADE
MEASUREMENTS: L2300 X D530 X H2000MM



ART. NO. 4731713
EXTRA DEEP STAINLESS STEEL TOP BLADE
MEASUREMENTS: L2604 X D600 X H2000MM



ART. NO. 4731401 WOODEN TOP BLADE
ART. NO. 4731701 STAINLESS STEEL TOP BLADE
MEASUREMENTS: L2300 X D530 X H2000MM



ART. NO. 4731402 WOODEN TOP BLADE
ART. NO. 4731702 STAINLESS STEEL TOP BLADE
MEASUREMENTS: L1690 X D530 X H2000MM



ART. NO. 4731403 WOODEN TOP BLADE
ART. NO. 4731703 STAINLESS STEEL TOP BLADE
MEASUREMENTS: L1690 X D530 X H2000MM



ART. NO. 4731411 WOODEN TOP BLADE
ART. NO. 4731711 STAINLESS STEEL TOP BLADE
MEASUREMENTS: L1690 X D530 X H2000MM



ART. NO. 4731404 WOODEN TOP BLADE
ART. NO. 4731704 STAINLESS STEEL TOP BLADE
MEASUREMENTS: L1690 X D500 X H1002MM



ART. NO. 4731405 WOODEN TOP BLADE
ART. NO. 4731705 STAINLESS STEEL TOP BLADE
MEASUREMENTS: L1690 X D500 X H1002MM



ART. NO. 4731406 WOODEN TOP BLADE
ART. NO. 4731706 STAINLESS STEEL TOP BLADE
MEASUREMENTS: L1690 X D500 X H1002MM



GET ORGANIZED BE EFFICIENT



ART. NO. 4731613

EXTRA DEEP STAINLESS STEEL TOP BLADE

MEASUREMENTS: L2262 X D600 X H2000MM



ART. NO. 4730314 WOODEN TOP BLADE

ART. NO. 4731614 STAINLESS STEEL TOP BLADE

MEASUREMENTS: L3916 X D530 X H2000MM



ART. NO. 4730196 WOODEN TOP BLADE

ART. NO. 4731196 STAINLESS STEEL TOP BLADE

MEASUREMENTS: L1958 X D530 X H2000MM



ART. NO. 4731301 WOODEN TOP BLADE

ART. NO. 4731601 STAINLESS STEEL TOP BLADE

MEASUREMENTS: L1958 X D530 X H2000MM



ART. NO. 4731302 WOODEN TOP BLADE
ART. NO. 4731602 STAINLESS STEEL TOP BLADE
MEASUREMENTS: L1348 X D530 X H2000MM



ART. NO. 4731303 WOODEN TOP BLADE
ART. NO. 4731603 STAINLESS STEEL TOP BLADE
MEASUREMENTS: L1348 X D530 X H2000MM

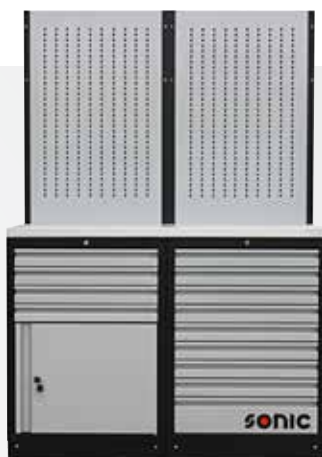

ART. NO. 4731304 WOODEN TOP BLADE
ART. NO. 4731604 STAINLESS STEEL TOP BLADE
MEASUREMENTS: L1348 X D530 X H2000MM



ART. NO. 4731305 WOODEN TOP BLADE
ART. NO. 4731605 STAINLESS STEEL TOP BLADE
MEASUREMENTS: L1348 X D500 X H1002MM



ART. NO. 4731306 WOODEN TOP BLADE
ART. NO. 4731606 STAINLESS STEEL TOP BLADE
MEASUREMENTS: L1348 X D500 X H1002MM



ART. NO. 4731307 WOODEN TOP BLADE
ART. NO. 4731607 STAINLESS STEEL TOP BLADE
MEASUREMENTS: L1348 X D500 X H1002MM

Tool box spare parts

TOP BLADE



ART. NO.	DESCRIPTION	L (MM)	W (MM)	H (MM)	G	PCS/BAG
47606	TOP BLADE	731	463	25	1360	1

AVAILABLE FOR S7 TOOL BOX

RUBBER MAT



ART. NO.	DESCRIPTION	L(MM)	W(MM)	H(MM)	G	PCS/BAG
47498	S10 RUBBER MAT	567	430	3	1182	1
47499	S11 RUBBER MAT	737	489	3	1718	1

TOP BLADE

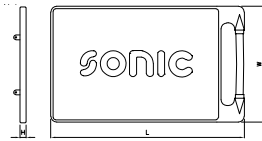

ART. NO.	DESCRIPTION	L (MM)	W (MM)	H (MM)	G	PCS/BAG
47374	WORKING PLATE	810	485	25	3120	1

AVAILABLE FOR TRADITIONAL TOOL BOX

TOP BLADE

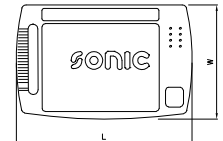

ART. NO.	DESCRIPTION	L (MM)	W (MM)	H (MM)	G	PCS/BAG
47262	S10 TOOL BOX PLASTIC WORKING PLATE	887	575	25	5600	1
47364	S11 JUMBO TOOL BOX PLASTIC WORKING PLATE	1051	635	25	4950	1

EVA MAT

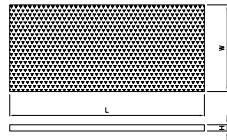

ART. NO.	DESCRIPTION	L (MM)	W (MM)	H (MM)	G	PCS/BAG
47213	EVA MAT	680	450	10	460	1

AVAILABLE FOR S8 TOOL BOX

TOP BLADE



ART. NO.	DESCRIPTION	L(MM)	W(MM)	H(MM)	G	PCS/BAG
47614	S9 SS TOP PLATE	640	507.5	71	52000	1
47615	S12 SS TOP PLATE	811	507.5	71	71000	1

RUBBER MAT



ART. NO.	DESCRIPTION	L (MM)	W (MM)	H (MM)	G	PCS/BAG
47581	S8 RUBBER MAT 10MM	682	484	10	460	1

AVAILABLE FOR S8 TOOL BOX

WOODEN TOP BLADE

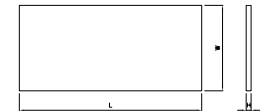

ART. NO.	DESCRIPTION	L (MM)	W (MM)	H (MM)	G	PCS/BAG
47257	OAK TOP PLATE	1182	732	32	21970	1

AVAILABLE FOR S13 TOOL BOX

RUBBER MAT



ART. NO.	DESCRIPTION	L (MM)	W (MM)	H (MM)	G	PCS/BAG
47548	S9 3MM RUBBER MAT	634	410	3	1320	1
47580	S12 3MM RUBBER MAT	805	410	3	1740	1

WOODEN TOP BLADE



ART. NO.	DESCRIPTION	L (MM)	W (MM)	H (MM)	G	PCS/BAG
47252	OAK TOP PLATE	1353	634	32	14170	1

AVAILABLE FOR S14 TOOL BOX

EVA MAT

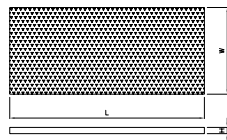

ART. NO.	DESCRIPTION	L (MM)	W (MM)	H (MM)	G	PCS/BAG
47224	EVA MAT	855	495	10	424	1

AVAILABLE FOR JUMBO TOOL BOX

TOP BLADE

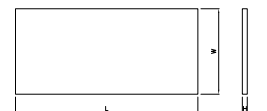

ART. NO.	DESCRIPTION	L(MM)	W(MM)	H(MM)	G	PCS/BAG
47601	S15 SS TOP PLATE	1667	710	38	48500	1

SUPPORT SHAFT



ART. NO.	DESCRIPTION	L(MM)	W(MM)	H(MM)	G	PCS/BAG
47551	SUPPORT SHAFT	80	360-435	561-761	3300	1

AVAILABLE FOR S10 GLASS TOOL BOX

HANDLE



ART. NO.	DESCRIPTION	L (MM)	G	PCS/BAG
47211	BLACK HANDLE	446	680	1

AVAILABLE FOR S8 TOOL BOX

HANDLE

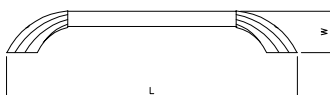

ART. NO.	DESCRIPTION	L (MM)	W (MM)	G	PCS/BAG
47251	SIDE HANDLE (SILVER)	572	82,2	3000	1

AVAILABLE FOR S14 TOOL BOX

PAPER HOLDER

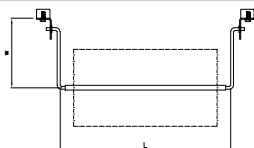

ART. NO.	DESCRIPTION	L (MM)	W (MM)	G	PCS/BAG
47522	PAPER HOLDER DARK GREY	279	134	500	1

AVAILABLE FOR S9 AND S12 TOOL BOX

PAPER HOLDERS

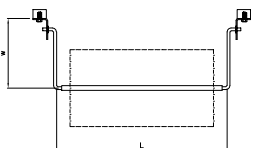

ART.NO.	DESCRIPTION	L(MM)	W(MM)	G	PCS/BAG
47230	PAPER HOLDER BLACK	325	134	338	1
47231	PAPER HOLDER RED	325	134	338	1
47232	PAPER HOLDER BLUE	325	134	338	1
47369	PAPER HOLDER GREY	325	134	338	1

AVAILABLE FOR S10, S11, S13 AND S14 TOOL BOX

PAPER HOLDER

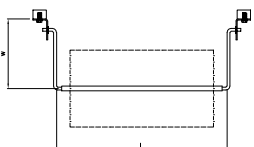

ART. NO.	DESCRIPTION	L(MM)	W(MM)	G	PCS/BAG
47549	PAPER HOLDER BLACK	325	134	338	1

AVAILABLE FOR S10 GLASS TROLLEY

PAPER HOLDERS

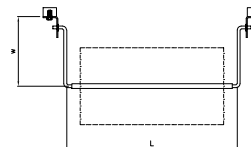

ART.NO	DESCRIPTION	L(MM)	W(MM)	G	PCS/BAG
47267	PAPERROL HOLDER BLACK (S10, S11, S13)	325	134	338	1
47334	PAPERROL HOLDER RED (S10, S11, S13)	325	134	338	1
47232	PAPERROL HOLDER BLUE	325	134	338	1
47369	PAPER HOLDER GREY (S10, S11)	325	134	338	1

AVAILABLE FOR S10, S11 AND S13 TOOL BOX

TROLLEY COVER



ART. NO.	DESCRIPTION	L(MM)	W(MM)	H(MM)	G	PCS/BAG
47422	COVER FOR S10 TOOL BOX	900	590	900	3116	1
47423	COVER FOR S11 TOOL BOX	1070	650	900	4030	1
47636	COVER FOR S12 TOOL BOX	1045	550	900	2480	1
47424	COVER FOR S9 AND SWS TOOL BOX	865	502	900	2480	1
47425	COVER FOR S8 TOOL BOX	710	500	900	2140	1
47501	COVER FOR S14 TOOL BOX	1363	640	1000	5000	1

UTILITY MAGNATIC TOOL HOLDER



ART. NO.	DESCRIPTION
815001	- BLACK COATED FLAT PANEL - GREY RACK AND HOLDER - WITH TWO MAGNETIC PADS

CAN HOLDER



ART.NO.	DESCRIPTION	L(MM)	W(MM)	H(MM)	G	PCS/BAG
47609	CANHOLDER BLACK	351	95	110	500	1

AVAILABLE FOR S7 TOOL BOX

CAN HOLDER

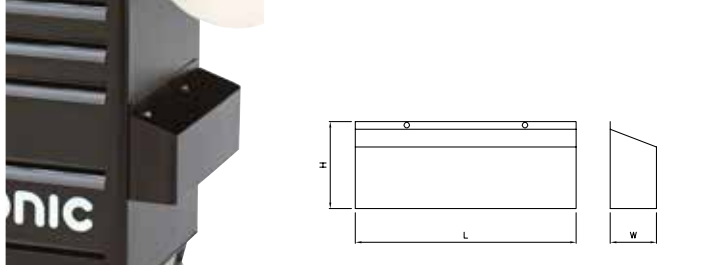

ART. NO.	DESCRIPTION	L(MM)	W(MM)	H(MM)	G	PCS/BAG
47204	BLACK CAN HOLDER	430	90	170	1600	1

AVAILABLE FOR S8 AND S13 TOOL BOX

CAN HOLDER

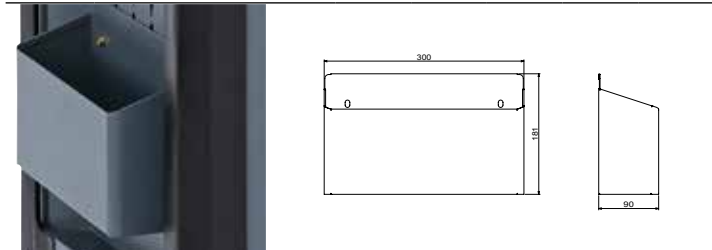

ART. NO.	DESCRIPTION	L(MM)	W(MM)	H(MM)	G	PCS/BAG
47519	CAN HOLDER DARK GRAY	300	181	90	1800	1

AVAILABLE FOR S9 AND S12 TOOL BOX

CAN HOLDERS

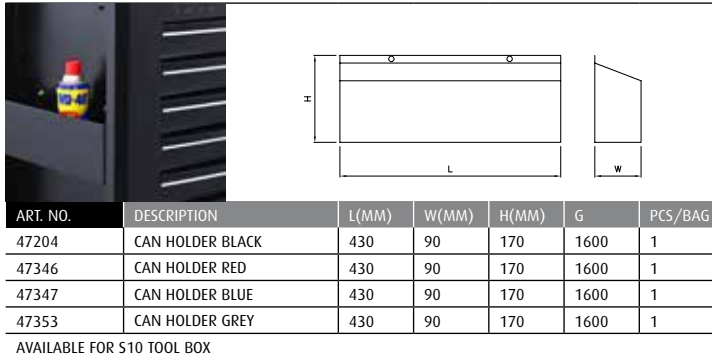

ART. NO.	DESCRIPTION	L(MM)	W(MM)	H(MM)	G	PCS/BAG
47204	CAN HOLDER BLACK	430	90	170	1600	1
47346	CAN HOLDER RED	430	90	170	1600	1
47347	CAN HOLDER BLUE	430	90	170	1600	1
47353	CAN HOLDER GREY	430	90	170	1600	1

AVAILABLE FOR S10 TOOL BOX

CAN HOLDERS

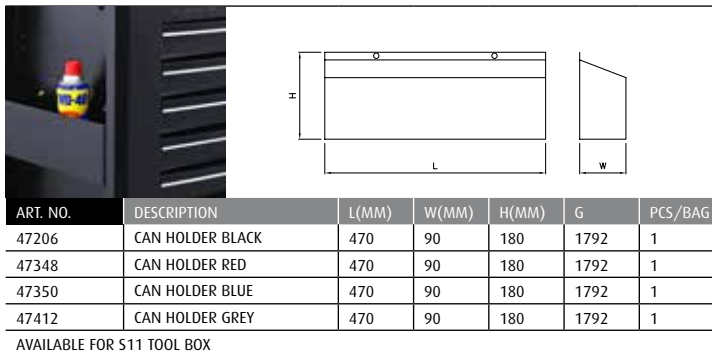

ART. NO.	DESCRIPTION	L(MM)	W(MM)	H(MM)	G	PCS/BAG
47206	CAN HOLDER BLACK	470	90	180	1792	1
47348	CAN HOLDER RED	470	90	180	1792	1
47350	CAN HOLDER BLUE	470	90	180	1792	1
47412	CAN HOLDER GREY	470	90	180	1792	1

AVAILABLE FOR S11 TOOL BOX

CAN HOLDER

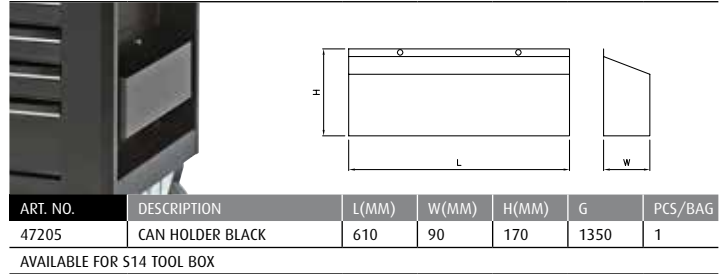

ART. NO.	DESCRIPTION	L(MM)	W(MM)	H(MM)	G	PCS/BAG
47205	CAN HOLDER BLACK	610	90	170	1350	1

AVAILABLE FOR S14 TOOL BOX

CAN HOLDER

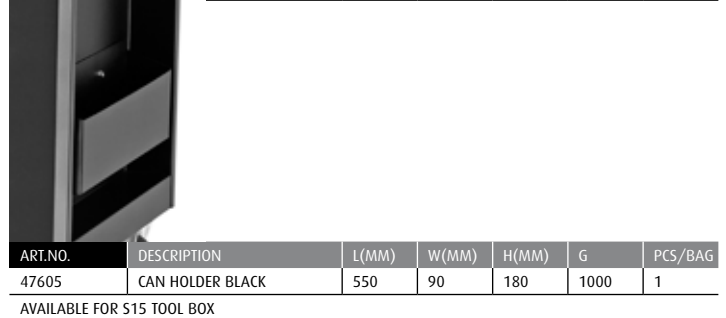

ART. NO.	DESCRIPTION	L(MM)	W(MM)	H(MM)	G	PCS/BAG
47605	CAN HOLDER BLACK	550	90	180	1000	1

AVAILABLE FOR S15 TOOL BOX

DOCUMENT HOLDER

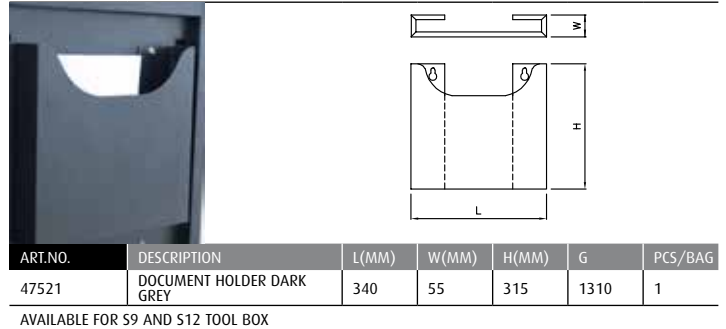

ART. NO.	DESCRIPTION	L(MM)	W(MM)	H(MM)	G	PCS/BAG
47521	DOCUMENT HOLDER DARK GREY	340	55	315	1310	1

AVAILABLE FOR S9 AND S12 TOOL BOX

DOCUMENT HOLDERS

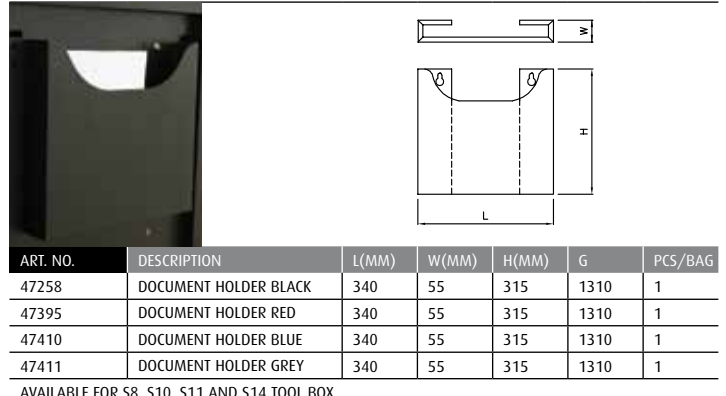

ART. NO.	DESCRIPTION	L(MM)	W(MM)	H(MM)	G	PCS/BAG
47258	DOCUMENT HOLDER BLACK	340	55	315	1310	1
47395	DOCUMENT HOLDER RED	340	55	315	1310	1
47410	DOCUMENT HOLDER BLUE	340	55	315	1310	1
47411	DOCUMENT HOLDER GREY	340	55	315	1310	1

AVAILABLE FOR S8, S10, S11 AND S14 TOOL BOX

PAPER BASKET

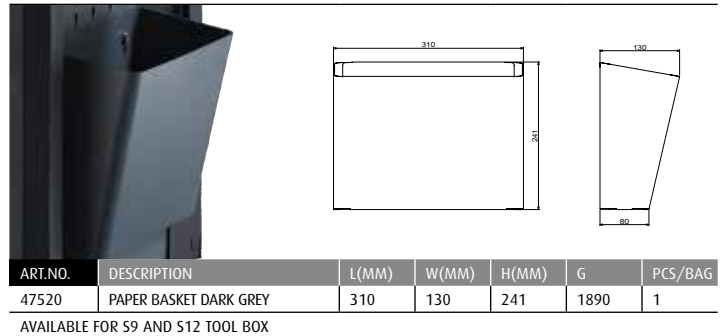

ART. NO.	DESCRIPTION	L(MM)	W(MM)	H(MM)	G	PCS/BAG
47520	PAPER BASKET DARK GREY	310	130	241	1890	1

AVAILABLE FOR S9 AND S12 TOOL BOX

PAPER BASKETS

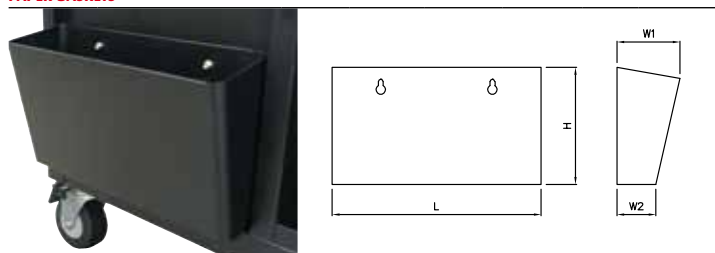

ART. NO.	DESCRIPTION	L(MM)	W1(MM)	W2(MM)	H(MM)	G	PCS/BAG
47259	PAPER BASKET BLACK	430	130	80	241	1890	1
47273	PAPER BASKET RED	430	130	80	241	1890	1
47322	PAPER BASKET BLUE	430	130	80	241	1890	1
47368	PAPER BASKET GREY	430	130	80	241	1890	1

AVAILABLE FOR S8, S10, S11, S13 AND S14 TOOL BOX

SIDE TABLE



ART. NO.	DESCRIPTION	L(MM)	W(MM)	H(MM)	G	PCS/BAG
47264	SIDE TABLE 454 X 302 MM	454	302	30	4400	1

AVAILABLE FOR S8 TOOL BOX

CASTER SETS

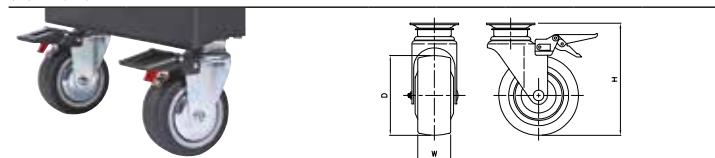

ART. NO.	DESCRIPTION	D(MM)	W(MM)	H(MM)	G	PCS/BAG
47209	4-PCS CASTER SET	125	50	180	4880	1
47209S	SWIVEL CASTER	125	50	180	1240	1
47209F	FIXED CASTER	125	50	180	1200	1

AVAILABLE FOR S8, S9, S10 AND S11 TOOL BOX

CASTER SETS

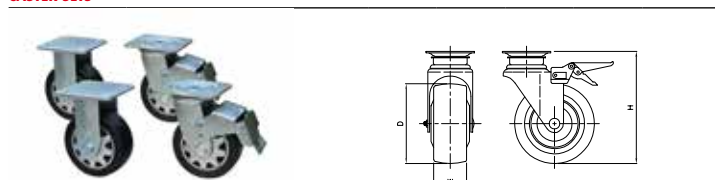

ART.NO	DESCRIPTION	D(MM)	W(MM)	H(MM)	G	PCS/BAG
47568	CASTER SET 4-PCS S10 4733115	125	50	180	1896	1
47568F	FIXED CASTER S10 4733115	125	50	180	1200	1
47568S	SWIVEL CASTER S10 4733115	125	50	180	1240	1

AVAILABLE FOR S10 GLASS TOOLBOX

CASTER SETS

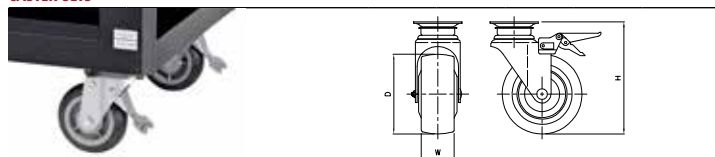

ART. NO.	DESCRIPTION	D(MM)	W(MM)	H(MM)	G	PCS/BAG
47631	CASTER 4-PCS	150	51	195	9400	1
47631F	FIXED CASTER	150	51	195	2100	1
47631S	SWIVEL CASTER	150	51	195	2600	1

AVAILABLE FOR S13, S14 AND S15 TOOL BOX

CASTER SETS

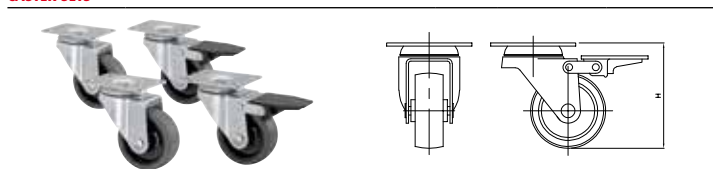

ART. NO.	DESCRIPTION	H(MM)	G	PCS/BAG
47494	4-PCS CASTER SET	87	2940	1
47494B	CASTER WITH BRAKE	87	288	1
47494S	CASTER	87	328	1

AVAILABLE FOR MSS 47451 TOOL BOX

CASTER SET AND HANDLE



ART. NO.	DESCRIPTION	L(MM)	W(MM)	D(MM)	H(MM)	G	PCS/BAG
47561	4-PCS CASTER SET	-	50	125	180	4872	1
	HANDLE	430	46	-	324	1350	1

AVAILABLE FOR S9 TOP BOX TROLLEY

CASTER SET

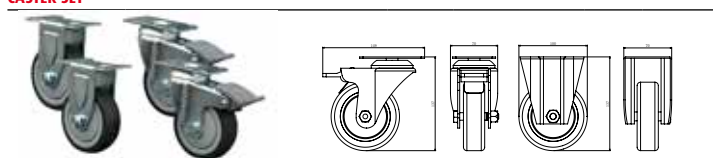

ART.NO.	DESCRIPTION	D(MM)	W(MM)	H(MM)	G	PCS/BAG
47573	4-PCS CASTER SET	150	70	137	1232	1
47573F	FIXED CASTER	100	70	137	540	1
47573S	SWIVEL CASTER	150	70	137	910	1

AVAILABLE FOR SERVICE CART

DRAWER RAILS

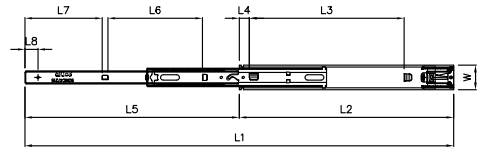

ART. NO.	DESCRIPTION	L1(MM)	L2(MM)	L3(MM)	L4(MM)	L5(MM)	L6(MM)	L7(MM)	L8(MM)	W(MM)	G	PCS/BAG
47215	LEFT DRAWER RAIL	800	400	290	19	400	178	144	24	45	584	1
47216	RIGHT DRAWER RAIL	800	400	290	19	400	178	144	24	45	584	1

AVAILABLE FOR S8, S9, S10, S13 TOOL BOX AND MSS

DRAWER RAILS

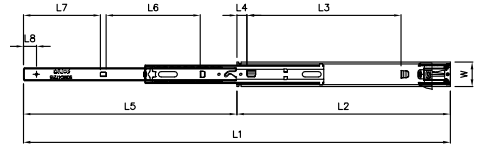

ART. NO.	DESCRIPTION	L1(MM)	L2(MM)	L3(MM)	L4(MM)	L5(MM)	L6(MM)	L7(MM)	L8(MM)	W(MM)	G	PCS/BAG
47328	RIGHT DRAWER RAIL W/PLASTIC	800	400	290	19	400	178	144	24	45	572	1

AVAILABLE FOR S8, S9, S10, S13 TOOL BOX AND MSS

DRAWER RAILS

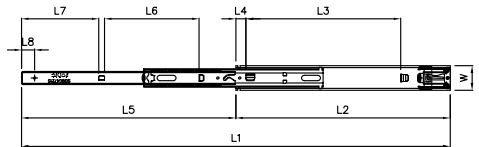

ART. NO.	DESCRIPTION	L1(MM)	L2(MM)	L3(MM)	L4(MM)	L5(MM)	L6(MM)	L7(MM)	L8(MM)	W(MM)	G	PCS/BAG
47217	LEFT DRAWER RAIL	870	435	290	19	435	178	144	24	45	644	1
47218	RIGHT DRAWER RAIL	870	435	290	19	435	178	144	24	45	644	1

AVAILABLE FOR S11, S12 TOOL BOX MSS AND SWS

DRAWER RAILS

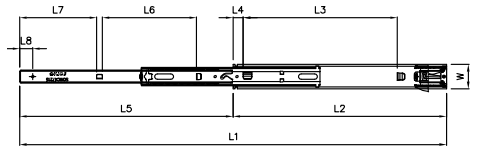

ART. NO.	DESCRIPTION	L1(MM)	L2(MM)	L3(MM)	L4(MM)	L5(MM)	L6(MM)	L7(MM)	L8(MM)	W(MM)	G	PCS/BAG
47329	RIGHT DRAWER RAIL W/PLASTIC	870	435	290	19	435	178	144	24	45	626	1

AVAILABLE FOR S11, S12 TOOL BOX MSS AND SWS

DRAWER RAILS

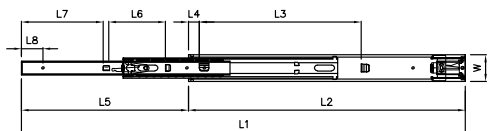

ART. NO.	DESCRIPTION	L1 (MM)	L2 (MM)	L3 (MM)	L4 (MM)	L5 (MM)	L6 (MM)	L7 (MM)	L8 (MM)	W (MM)	G	PCS/BAG
47243	LEFT DRAWER RAIL	1154	577	290	19	577	178	144	24	45.7	852	1
47244	RIGHT DRAWER RAIL	1154	577	290	19	577	178	144	24	45.7	852	1

AVAILABLE FOR S14, S15 TOOL BOX MWS AND WORK BENCH

DRAWER RAILS

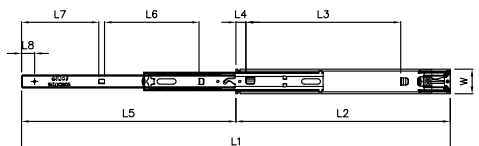

ART. NO.	DESCRIPTION	L1(MM)	L2(MM)	L3(MM)	L4(MM)	L5(MM)	L6(MM)	L7(MM)	W (MM)	G	PCS/BAG
47261	RAIL OF 4730413 DRAWER (LEFT OR RIGHT)	422	200	147.5	6.5	197	144.5	32.5	35	210	1

AVAILABLE FOR MINI TOPCHEST

DRAWERS



ART. NO.	DESCRIPTION	L(MM)	W(MM)	H(MM)	G	PCS/BAG
47607	SMALL DRAWER	580	385	73	2100	1
47608	BIG DRAWER WITH LOGO	580	385	153	3200	1
47610	BIG DRAWER WITHOUT LOGO	580	385	153	3200	1

AVAILABLE FOR S7 TOOL BOX

DRAWERS

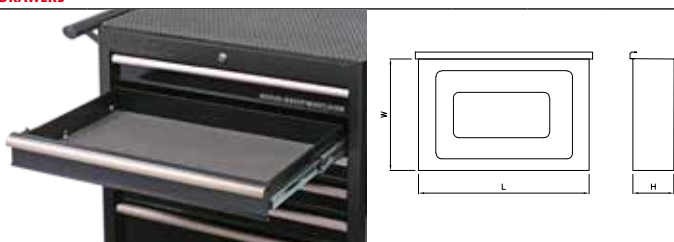

ART. NO.	DESCRIPTION	L(MM)	W(MM)	H(MM)	G	PCS/BAG
47253	SHALLOW DRAWER	577	377	60	3100	1
47254	DEEP DRAWER WITH LOGO	577	377	140	4600	1
47396	DEEP DRAWER WITHOUT LOGO	577	377	140	4600	1

AVAILABLE FOR S8 TOOL BOX

DRAWERS

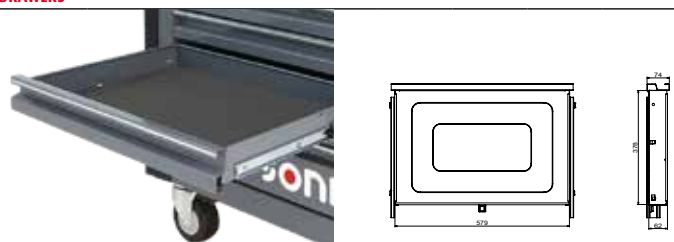

ART. NO.	DESCRIPTION	L(MM)	W(MM)	H(MM)	G	PCS/BAG
47517	SHALLOW DRAWER	579	378	62	3100	1
47518	DEEP DRAWER	579	378	141	4100	1

AVAILABLE FOR S9 TOOL BOX

DRAWERS

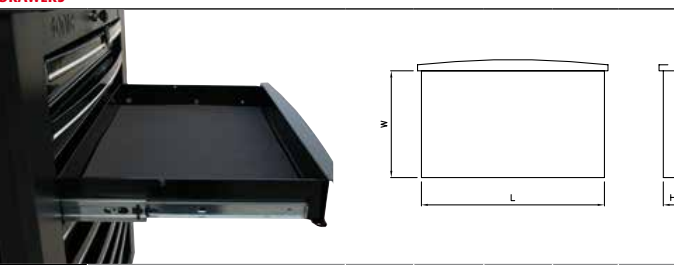

ART. NO.	DESCRIPTION	L(MM)	W(MM)	H(MM)	G	PCS/BAG
47265	SHALLOW DRAWER, BLACK	577	377	60	3100	1
47266	DEEP DRAWER, BLACK	577	377	140	4100	1
47318	SHALLOW DRAWER, RED	577	377	60	3100	1
47319	DEEP DRAWER, RED	577	377	140	4100	1
47320	SHALLOW DRAWER, BLUE	577	377	60	3100	1
47321	DEEP DRAWER, BLUE	577	377	140	4100	1
47391	SHALLOW DRAWER, GREY	577	377	60	3100	1
47392	DEEP DRAWER, GREY	577	377	140	4100	1

AVAILABLE FOR S10 TOOL BOX

DRAWERS



ART. NO.	DESCRIPTION	L(MM)	W(MM)	H(MM)	G	PCS/BAG
47550	DEEP DRAWER WITH LOGO	577	377	140	4100	1
47553	DEEP DRAWER WITHOUT LOGO	577	377	140	4100	1

AVAILABLE FOR S10 GLASS TOOL BOX

DRAWERS

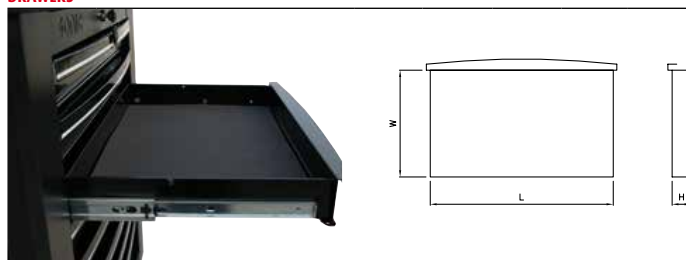

ART. NO.	DESCRIPTION	L(MM)	W(MM)	H(MM)	G	PCS/BAG
47337	SHALLOW DRAWER, RED	750	435	60	4238	1
47338	DEEP DRAWER, RED	750	435	140	5868	1
47339	SHALLOW DRAWER, BLUE	750	435	60	4238	1
47340	DEEP DRAWER, BLUE	750	435	140	5868	1
47365	SHALLOW DRAWER, BLACK	750	435	60	4238	1
47366	DEEP DRAWER, BLACK	750	435	140	5868	1
47393	SHALLOW DRAWER, GREY	750	435	60	4238	1
47394	DEEP DRAWER, GREY	750	435	140	5868	1

AVAILABLE FOR S11 TOOL BOX

DRAWERS



ART. NO.	DESCRIPTION	L(MM)	W(MM)	H(MM)	G	PCS/BAG
47546	SHALLOW FOR, DARK GREY	747	440	60	4238	1
47547	DEEP DRAWER FOR, DARK GREY	747	440	140	5868	1

AVAILABLE FOR S12 TOOL BOX

DRAWERS

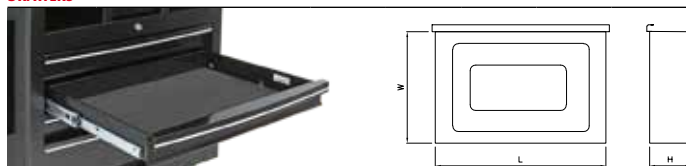

ART. NO.	DESCRIPTION	L(MM)	W(MM)	H(MM)	G	PCS/BAG
47265	SHALLOW DRAWER	577	377	60	3100	1
47266	DEEP DRAWER	577	377	140	4100	1
47523	SMALL DRAWER	147	378	62	1010	1

AVAILABLE FOR S13 TOOL BOX

DRAWERS

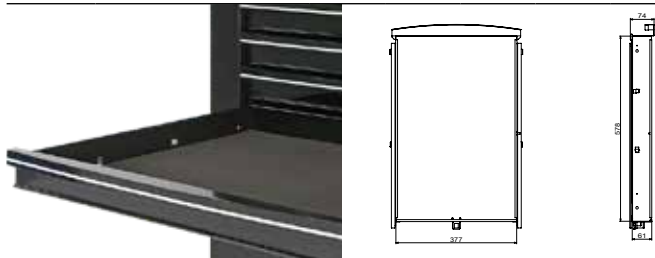

ART. NO.	DESCRIPTION	L(MM)	W(MM)	H(MM)	G	PCS/BAG
47513	SHALLOW DRAWER	377	575	61	2900	1
47514	DEEP DRAWER	377	575	153	4300	1
47515	SHALLOW DRAWER	750	575	61	5000	1
47516	DEEP DRAWER	750	575	153	7000	1

AVAILABLE FOR S14 TOOL BOX

DRAWERS



ART. NO.	DESCRIPTION	L(MM)	W(MM)	H(MM)	G	PCS/BAG
47602	TOP DRAWER	1439	575	196	13000	1
47603	SHALLOW DRAWER	575	575	74	3700	1
47604	DEEP DRAWER WITH LOGO	575	575	153	5500	1

AVAILABLE FOR S15 TOOL BOX

DRAWERS



ART. NO.	DESCRIPTION	L(MM)	W(MM)	H(MM)	G	PCS/BAG
47637	SHALLOW DRAWER	496	201.5	53	1000	1

AVAILABLE FOR MINI TOPCHEST

METAL KNOB

ART. NO.	DESCRIPTION	L(MM)	W(MM)	H(MM)	G	PCS/BAG
47630	METAL KNOB FOR SHELVES LOCKERS	20	16	-	3	1

AVAILABLE FOR MSS

DRAWERS



ART. NO.	DESCRIPTION	L(MM)	W(MM)	H(MM)	G	PCS/BAG
47281	SHALLOW DRAWER FOR MSS 26"	604	401	74	4100	1
47282	DEEP DRAWER WITH LOGO FOR MSS 26"	604	401	153	5500	1
47491	DEEP DRAWER WITHOUT LOGO FOR MSS 26"	604	401	153	5500	1
47641	EXTRA DEEP DRAWER WITH LOGO FOR MSS 26"	604	401	232		1
47642	EXTRA DEEP DRAWER WITHOUT LOGO FOR MSS 26"	604	401	232		1
47297	SHALLOW DRAWER FOR MSS 34"	775	461	74	5100	1
47298	DEEP DRAWER WITH LOGO FOR MSS 34"	775	461	153	7200	1
47414	DEEP DRAWER WITHOUT LOGO FOR MSS 34"	775	461	153	7200	1

AVAILABLE FOR MSS

DRAWER



ART. NO.	DESCRIPTION	L(MM)	W(MM)	H(MM)	G	PCS/BAG
47452	MSS BIN DRAWER FOR 47450	604	432	785	8500	1

DRAWERS



ART. NO.	DESCRIPTION	L(MM)	W(MM)	H(MM)	G	PCS/BAG
47466	SHALLOW DRAWER FOR 32" SWS 47458 (BLACK)	604	381	74	4200	1
47480	SHALLOW DRAWER FOR 32" SWS 47472 (RED)	604	381	74	4200	1
47467	DEEP DRAWER FOR 32" SWS 47458 (BLACK)	604	381	153	5300	1
47481	DEEP DRAWER FOR 32" SWS 47472 (RED)	604	381	153	5300	1
47468	DEEP DRAWER WITH LOGO FOR 32" SWS 47458 (BLACK)	604	381	153	5300	1
47482	DEEP DRAWER WITH LOGO FOR 32" SWS 47472 (RED)	604	381	153	5300	1

AVAILABLE FOR SWS

DRAWERS



ART. NO.	DESCRIPTION	L(MM)	W(MM)	H(MM)	G	PCS/BAG
47464	SHALLOW DRAWER FOR 32" SWS 47457 (BLACK)	604	462	310	7600	1
47478	SHALLOW DRAWER FOR 32" SWS 47471 (RED)	604	462	310	7600	1
47465	DEEP DRAWER WITH LOGO FOR 32" SWS 47457 (BLACK)	604	462	390	8400	1
47479	DEEP DRAWER WITH LOGO FOR 32" SWS 47471 (RED)	604	462	390	8400	1

AVAILABLE FOR SWS

DRAWERS



ART. NO.	DESCRIPTION	L(MM)	W(MM)	H(MM)	G	PCS/BAG
47462	LOWER DRAWER FOR 32" SWS 47456 (BLACK)	332	485	310	6200	1
47476	LOWER DRAWER FOR 32" SWS 47470 (RED)	332	485	310	6200	1

AVAILABLE FOR SWS

DRAWERS



ART. NO.	DESCRIPTION	L(MM)	W(MM)	H(MM)	G	PCS/BAG
47484	DEEP DRAWER FOR 41" WB	326	642	690	6004	1
47485	SHALLOW DRAWER FOR 41" WB	326	642	342	4900	1
47486	SHALLOW DRAWER WITH LOGO FOR 41" WB	326	642	342	4900	1

AVAILABLE FOR WB

DRAWERS



ART. NO.	DESCRIPTION	L(MM)	W(MM)	H(MM)	G	PCS/BAG
47461	DEEP DRAWER FOR 32" SWS 47456 (BLACK)	236	485	705	6500	1
47475	DEEP DRAWER FOR 32" SWS 47470 (RED)	236	485	705	6500	1

AVAILABLE FOR SWS

RECYCLE BIN



ART. NO.	DESCRIPTION	L(MM)	W(MM)	H(MM)	G	PCS/BAG
47463	RECYCLE BIN 32" SWS	190	430	400	1800	1

AVAILABLE FOR SWS

DRAWERS



ART. NO.	DESCRIPTION	L(MM)	W(MM)	H(MM)	G	PCS/BAG
47487	DEEP DOUBLE BIN FOR 41" WB	300	261	650	2320	1
47488	SHALLOW DOUBLE BIN FOR 41" WB	300	261	302	1200	1
47489	SHALLOW BIN FOR 41" WB	606	261	260	1740	1

AVAILABLE FOR WB

SKIRTING BOARD



ART. NO.	DESCRIPTION	L(MM)	W(MM)	H(MM)	G	PCS/BAG
47275	FRONT SKIRTING BOARD FOR MSS 24"	610	88	12	400	1
47289	FRONT SKIRTING BOARD FOR MSS 26"	674	88	12	420	1
47303	FRONT SKIRTING BOARD FOR MSS 34"	845	88	12	350	1
47541	FRONT SKIRTING BOARD FOR MSS 47S05	565	88	12	440	1
47310	SIDE SKIRTING BOARD FOR MSS 24"	507	88	12	380	1
47389	SIDE SKIRTING BOARD FOR MSS 26" AND 34"	477	88	12	380	1

AVAILABLE FOR MSS

FRONT SKIRTING BOARD



ART. NO.	DESCRIPTION	L(MM)	W(MM)	H(MM)	G	PCS/BAG
47459	SWS 32" SKIRTING FRONT BOARD (BLACK)	830	12	160	500	1
47473	SWS 32" SKIRTING FRONT BOARD (RED)	830	12	160	500	1

AVAILABLE FOR SWS

SHELF



ART. NO.	DESCRIPTION	L(MM)	W(MM)	H(MM)	G	PCS/BAG
47434	SHELF 36" FOR MSS LOCKER (47433)	847	495	25	4150	1

AVAILABLE FOR MSS

SHELF



ART. NO.	DESCRIPTION	L(MM)	W(MM)	H(MM)	G	PCS/BAG
47543	SHELF 34" FOR MSS CLOSET 47505	616	430	25	3400	1

AVAILABLE FOR MSS

SHELF



ART. NO.	DESCRIPTION	L(MM)	W(MM)	H(MM)	G	PCS/BAG
47460	SHELF FOR 32" SWS 47455 (BLACK)	615	450	25	1000	1
47474	SHELF FOR 32" SWS 47469 (RED)	615	450	25	1000	1

AVAILABLE FOR SWS

KEY AND LOCK



ART. NO.	DESCRIPTION	G	PCS/BAG
47210	KEY	14	2
47214	KEY WITH LOCK	60	1

AVAILABLE FOR S8, S9, S10, S11, S13, S14 TOOL BOX, MSS, MWS AND SWS

KEY AND LOCK



ART. NO.	DESCRIPTION	G	PCS/BAG
47622	KEY FOR TOOL BOX (2016)	14	1
47623	MASTERKEY FOR TOOL BOX (2016)	14	1
47624	KEY WITH LOCK (TOOL BOX /MSS/MWS 180° - 2016)	60	1
47625	KEY WITH LOCK (TOPBOX/TOOLBOX 90° - 2016)	60	1

AVAILABLE FOR S8, S9, S10, S11, S13, S14 TOOL BOX, MSS, MWS AND SWS

KEY AND LOCK



ART. NO.	DESCRIPTION	G	PCS/BAG
47386	KEY	14	2
47387	KEY WITH LOCK	60	1

AVAILABLE FOR TRADITIONAL AND JUMBO TOOL BOX, TRADITIONAL AND JUMBO TOPCHEST

Filled storage systems



S7



S8



S9



S9
TOPBOX



S10



S11



S12



S12
XD



S13



S14



S15



BLACK SERIES



ART. NO. 724842

248-PCS

5 DRAWERS FILLED WITH 248-PCS TOOLS

MAIN FEATURES

- 8 DRAWERS;
- 7 SHALLOW DRAWERS
- 1 DEEP DRAWER
- DRAWER BLOCKING SYSTEM, AS PROTECTION AGAINST TIPPING OVER
- 100% RETRACTABLE DRAWERS
- AUTO RETURN BALL BEARING SLIDES
- FRONT CENTRALIZED SAFETY LOCK
- FOLDING KEY
- STAINLESS STEEL TOPBLADE
- OVERALL WEIGHT 84KG
- STATIC LOAD CAPACITY: 400KG
- 4 EXTRA LARGE WHEELS Ø125MM;
- 2 CASTERS WITH ROLLING AND TURNING BRAKE
- 2 FIXED CASTERS
- DRAWER CAPACITY: 40KG
- MEASUREMENTS: L 859 X D 532 X H 1035MM



1 602412



2 313904



3 604905



4 601507



5 602106





BLACK SERIES



ART. NO. 736842

368-PCS

6 DRAWERS FILLED WITH 368-PCS TOOLS

MAIN FEATURES

- 8 DRAWERS;
- 7 SHALLOW DRAWERS
- 1 DEEP DRAWER
- DRAWER BLOCKING SYSTEM, AS PROTECTION AGAINST TIPPING OVER
- 100% RETRACTABLE DRAWERS
- AUTO RETURN BALL BEARING SLIDES
- FRONT CENTRALIZED SAFETY LOCK
- FOLDING KEY
- STAINLESS STEEL TOPBLADE
- OVERALL WEIGHT 84KG
- STATIC LOAD CAPACITY: 400KG
- 4 EXTRA LARGE WHEELS Ø125MM;
- 2 CASTERS WITH ROLLING AND TURNING BRAKE
- 2 FIXED CASTERS
- DRAWER CAPACITY: 40KG
- MEASUREMENTS: L 859 X D 532 X H 1035MM



1 602412



2 215705



3 309505



4 604905



5 602211



6 602106





BLACK SERIES

ART. NO. 747243

472-PCS

7 DRAWERS FILLED WITH 472-PCS TOOLS

MAIN FEATURES

- 8 DRAWERS;
- 7 SHALLOW DRAWERS
- 1 DEEP DRAWER
- DRAWER RELEASE SYSTEM, NO MECHANISM IN THE HANDLE
- 100% RETRACTABLE DRAWERS
- AUTO RETURN BALL BEARING SLIDES
- POWDER COATING EXTERIOR
- FRONT CENTRALIZED SAFETY LOCK
- FOLDING KEY
- STAINLESS STEEL TOPBLADE
- INTEGRATED CAN HOLDER
- PAPER ROLL HOLDER
- 4 EXTRA LARGE WHEELS Ø125MM;
- 2 CASTERS WITH ROLLING AND TURNING BRAKE
- 2 FIXED CASTERS
- OVERALL WEIGHT 97KG
- MEASUREMENTS: L 1030 X D 532 X H 1035MM



1 603206

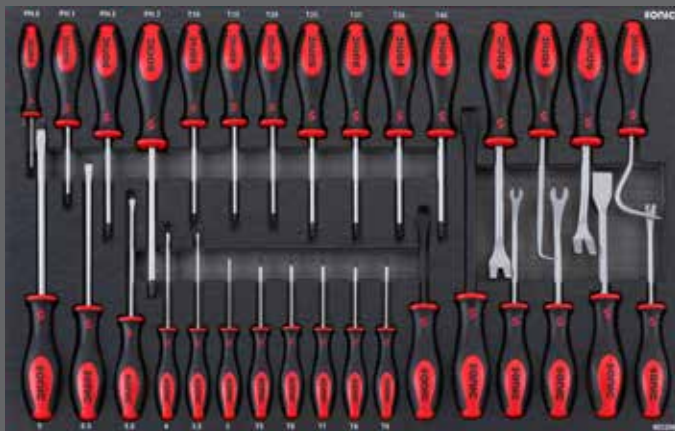

2 221204



3 308404





4 604904



5 602210



6 604205



7 603103





140-PCS

ART. NO. 714040

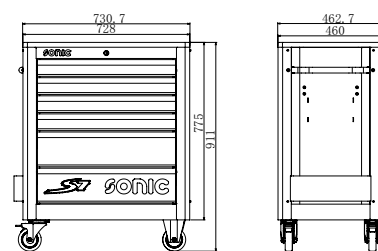

3 DRAWERS FILLED WITH 140-PCS TOOLS

MAIN FEATURES

- 6 DRAWERS
- 4 SHALLOW DRAWERS (DIM. 575 X 385 X 60MM)
- 2 DEEP DRAWERS (DIM. 575 X 385 X 137MM)
- NO DRAWER RELEASE SYSTEM INTEGRATED
- POWDER COATING EXTERIOR
- FRONT CENTRALIZED SAFETY LOCK
- FOLDING KEYS
- CAN HOLDER
- ABS TOP BLADE
- 4 CASTERS Ø 100MM, WHEREOF 2 SWIVEL CASTERS WITH ROLLING AND TURNING BRAKE
- OVERALL WEIGHT: 48KG
- STATIC LOAD CAPACITY: 400KG
- DRAWER CAPACITY: 40KG
- RAL BLACK: 9004

1 106105



2 206501



3 601404



206-PCS

ART. NO. 720606



241-PCS

ART. NO. 724006



3 DRAWERS FILLED WITH 206-PCS TOOLS

4 DRAWERS FILLED WITH 241-PCS TOOLS

MAIN FEATURES

- 7 DRAWERS;
- 5 SHALLOW DRAWERS
- 2 DEEP DRAWERS
- FOAM MAT
- CAN HOLDER
- FRONT CENTRALIZED SAFETY LOCK
- 100% RETRACTABLE DRAWERS
- POWDER COATING EXTERIOR
- BALL BEARING DRAWERS
- 4 EXTRA LARGE WHEELS Ø125MM, WHEREOF 2 CASTERS WITH ROLLING AND TURNING BRAKE

1 602904



2 316001



3 601707



1 602407

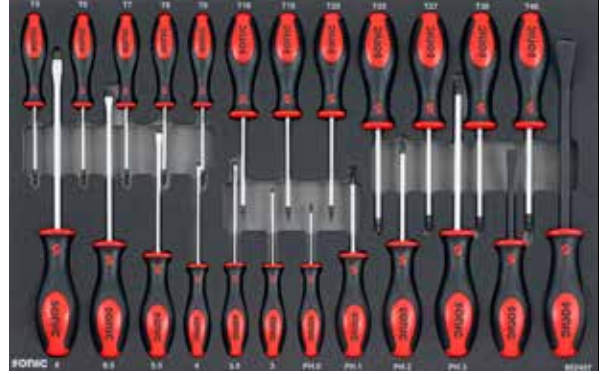

2 316001



3 604002

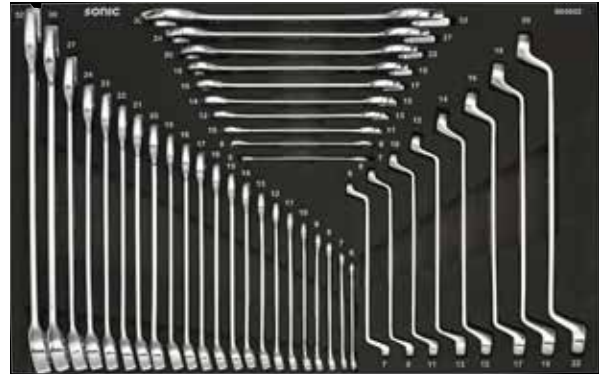

4 601707



285-PCS

ART. NO. 728406

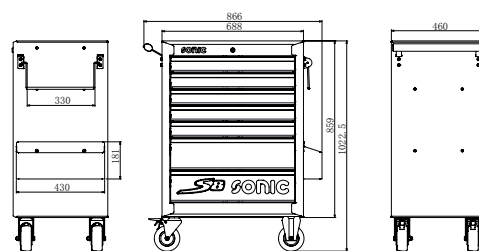

4 DRAWERS FILLED WITH 285-PCS TOOLS

MAIN FEATURES

- 7 DRAWERS;
- 5 SHALLOW DRAWERS
- 2 DEEP DRAWERS
- FOAM MAT
- CAN HOLDER
- FRONT CENTRALIZED SAFETY LOCK
- 100% RETRACTABLE DRAWERS
- POWDER COATING EXTERIOR
- BALL BEARING DRAWERS
- 4X EXTRA LARGE WHEELS Ø125MM, WHEREOF 2 CASTERS WITH ROLLING AND TURNING BRAKE



1 112102



2 310101



3 604002

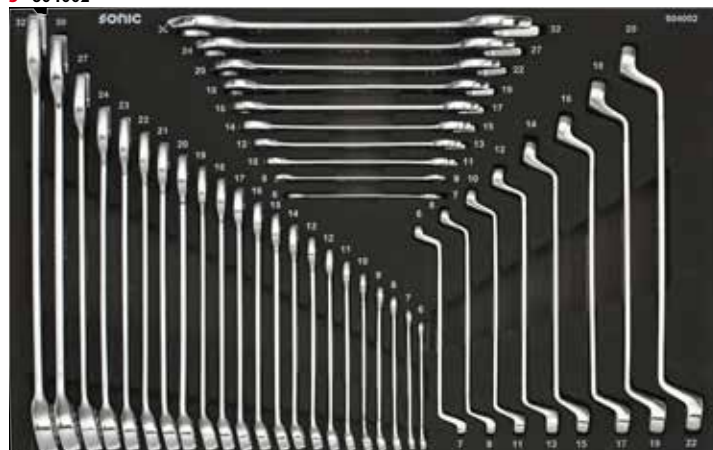

4 602302



ART. NO. 717331

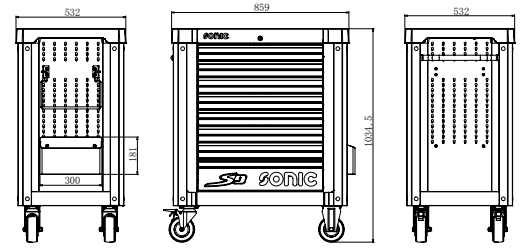

4 DRAWERS FILLED WITH 173-PCS TOOLS

MAIN FEATURES

- 8 DRAWERS;
- 7 SHALLOW DRAWERS
- 1 DEEP DRAWER
- DRAWER BLOCKING SYSTEM, AS PROTECTION AGAINST TIPPING OVER
- 100% RETRACTABLE DRAWERS
- AUTO RETURN BALL BEARING SLIDES
- FRONT CENTRALIZED SAFETY LOCK
- FOLDING KEY
- STAINLESS STEEL TOPBLADE
- 4 EXTRA LARGE WHEELS Ø125MM, WHEREOF 2 CASTERS WITH ROLLING AND TURNING BRAKE
- OVERALL WEIGHT 84KG
- STATIC LOAD CAPACITY: 400KG
- DRAWER CAPACITY: 40KG



FOR DETAILS ABOUT THE CONTENTS OF THE TOOL BOX, SEE CHAPTER TOOLS SETS

i MORE INFO WWW.SONIC-EQUIPMENT.COM

1 602407

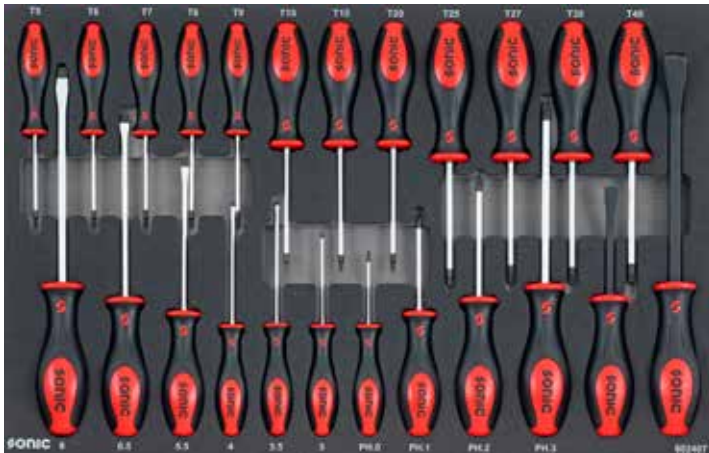

2 309302



3 603903

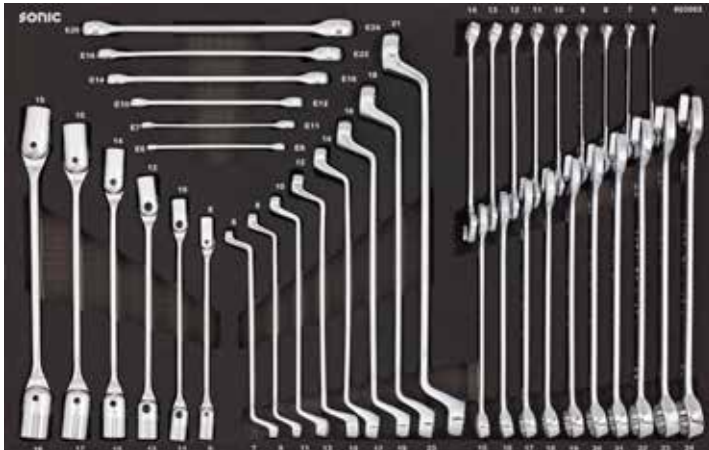

4 601707



171-PCS

ART. NO. 716931

SONIC
SAE
TOOLS



4 DRAWERS FILLED WITH 171-PCS TOOLS

MAIN FEATURES

- 8 DRAWERS: - 7 SHALLOW DRAWERS, - 1 DEEP DRAWER
- DRAWER BLOCKING SYSTEM, AS PROTECTION AGAINST TIPPING OVER
- 100% RETRACTABLE DRAWERS
- AUTO RETURN BALL BEARING SLIDES
- FRONT CENTRALIZED SAFETY LOCK
- 4 EXTRA LARGE WHEELS Ø125MM, WHEREOF 2 CASTERS WITH ROLLING AND TURNING BRAKE
- OVERALL WEIGHT 84KG
- DRAWERS 2 + 3 SAE SET

1 602407

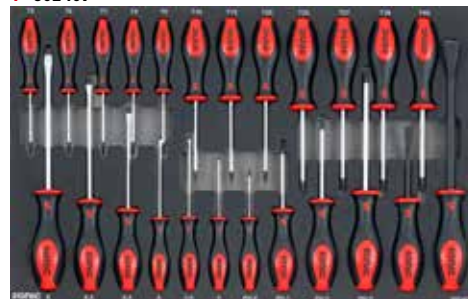

2 309301



3 603101



4 602302



357-PCS

ART. NO. 735231

6 DRAWERS FILLED WITH 357-PCS TOOLS



1 602407

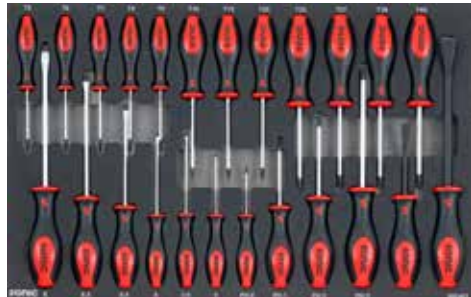

2 313902



3 604002

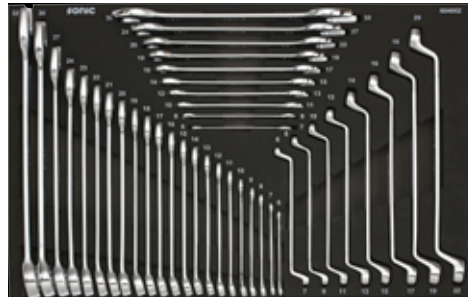

4 602302



5 310001



6 603101



ART. NO. 723931



5 DRAWERS FILLED WITH 239-PCS TOOLS

MAIN FEATURES

- 8 DRAWERS;
- 7 SHALLOW DRAWERS
- 1 DEEP DRAWER
- DRAWER BLOCKING SYSTEM, AS PROTECTION AGAINST TIPPING OVER
- 100% RETRACTABLE DRAWERS
- AUTO RETURN BALL BEARING SLIDES
- FRONT CENTRALIZED SAFETY LOCK
- FOLDING KEY
- STAINLESS STEEL TOPBLADE
- 4 EXTRA LARGE WHEELS Ø125MM, WHEREOF 2 CASTERS WITH ROLLING AND TURNING BRAKE
- OVERALL WEIGHT 84KG
- STATIC LOAD CAPACITY: 400KG
- DRAWER CAPACITY: 40KG
- MEASUREMENTS: L 859 X D 532 X H 1035MM

1 602407

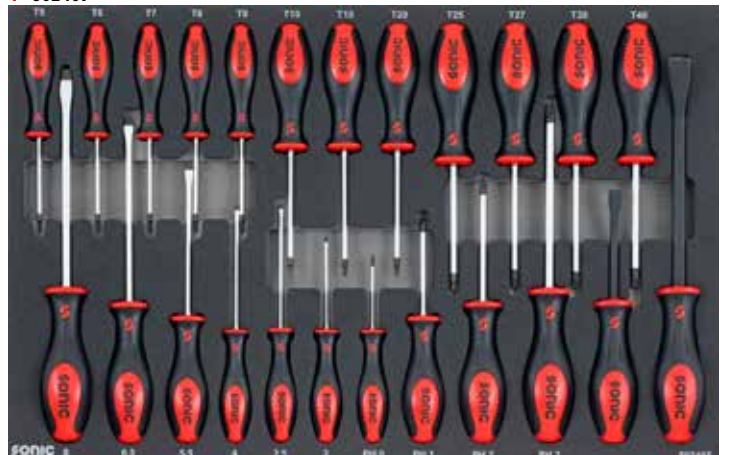

2 313902



3 604901



4 601207

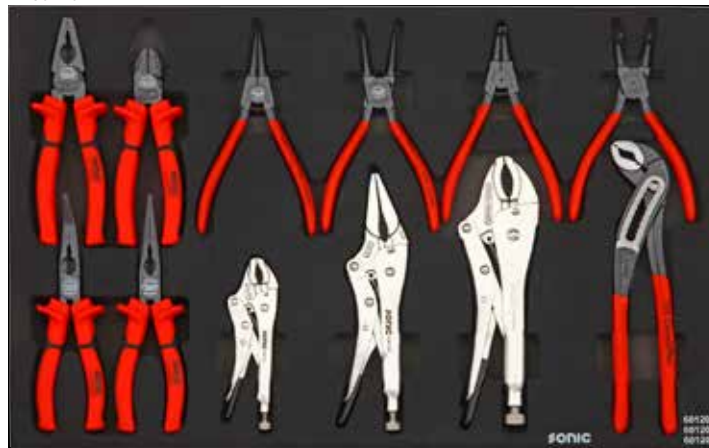

5 601601

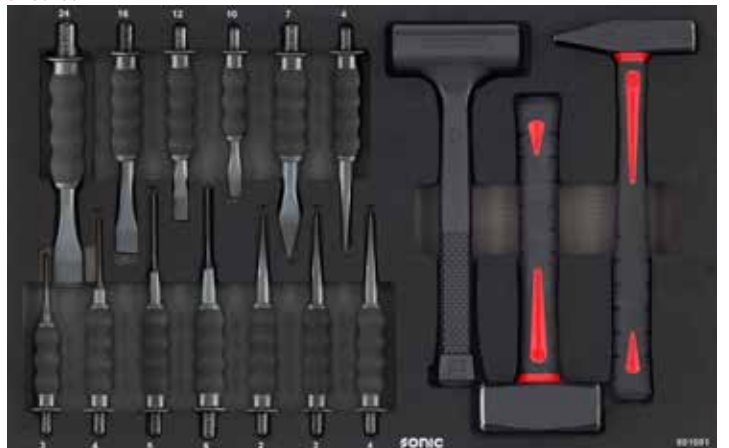

261-PCS

ART. NO. 726131



6 DRAWERS FILLED WITH 261-PCS TOOLS

FOR DETAILS ABOUT THE SPECIFICATIONS OF THE TOOL BOX, SEE CHAPTER EMPTY STORAGE SYSTEMS

FOR DETAILS ABOUT THE CONTENTS OF THE TOOL BOX, SEE CHAPTER TOOLS SETS

i MORE INFO WWW.SONIC-EQUIPMENT.COM

1 602407

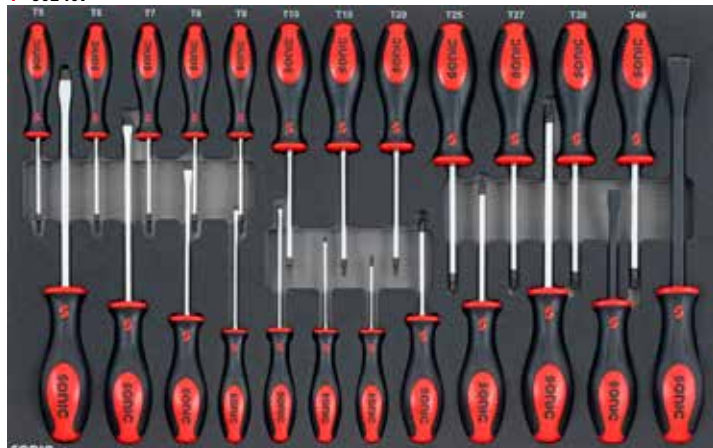

2 313902



3 604901



4 601207

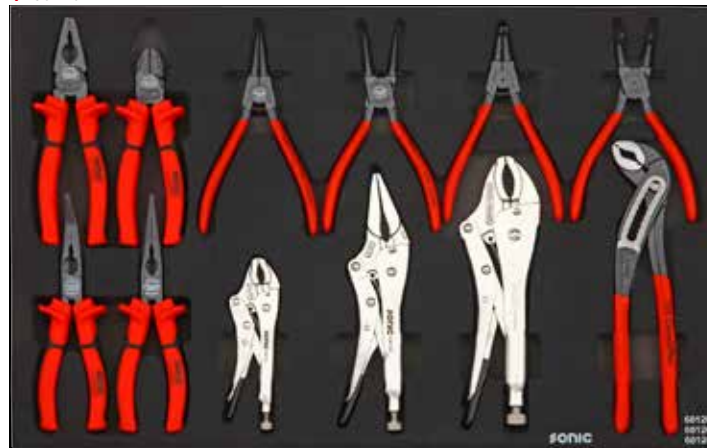

5 601601



6 602104



ART. NO. 726231	S9
ART. NO. 726209	S10
ART. NO. 726215	S10
ART. NO. 726216	S10
ART. NO. 726219	S10



5 DRAWERS FILLED WITH 262-PCS TOOLS

FOR DETAILS ABOUT THE SPECIFICATIONS OF THE TOOL BOX, SEE CHAPTER EMPTY STORAGE SYSTEMS

FOR DETAILS ABOUT THE CONTENTS OF THE TOOL BOX, SEE CHAPTER TOOLS SETS

i MORE INFO WWW.SONIC-EQUIPMENT.COM

1 602407

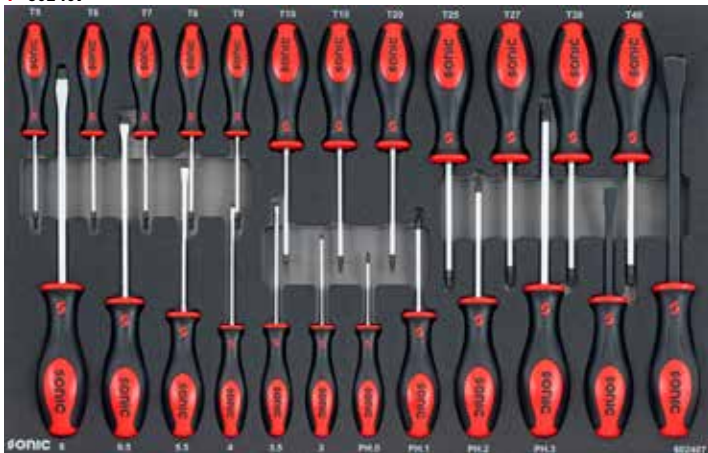

2 316001



3 604002

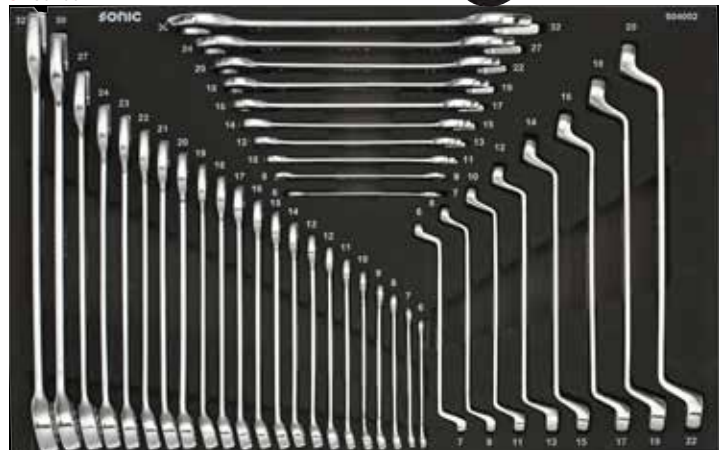

4 601707



5 602104



251-PCS



ART. NO. 725131	S9
ART. NO. 725109	S10
ART. NO. 725115	S10
ART. NO. 725116	S10
ART. NO. 725119	S10



5 DRAWERS FILLED WITH 251-PCS TOOLS

FOR DETAILS ABOUT THE SPECIFICATIONS OF THE TOOL BOX, SEE CHAPTER EMPTY STORAGE SYSTEMS

FOR DETAILS ABOUT THE CONTENTS OF THE TOOL BOX, SEE CHAPTER TOOLS SETS

i MORE INFO WWW.SONIC-EQUIPMENT.COM



1 600823 600824 106303

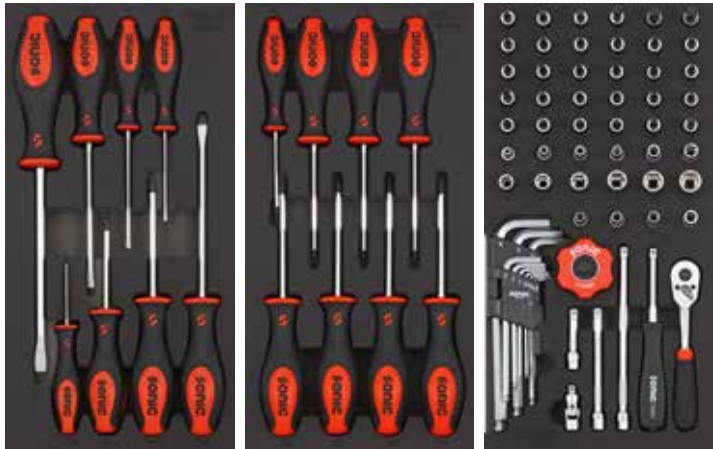

2 204101 300908 303805



3 601903 601225 601016

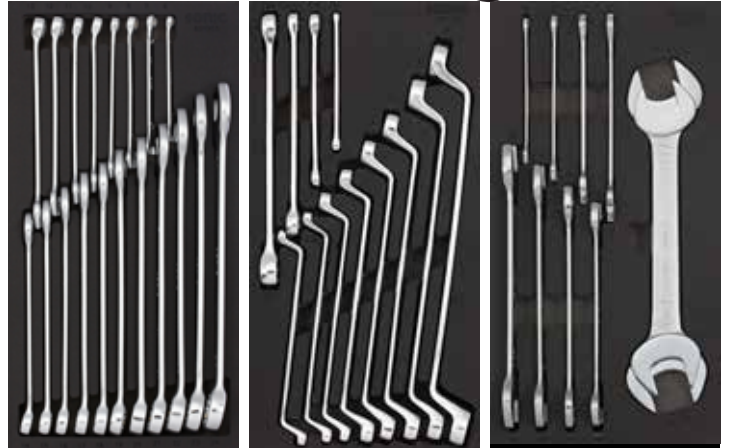

4 600319 601227 600614



5 600825 600705 600717



ART. NO. 727731	S9
ART. NO. 727709	S10
ART. NO. 727715	S10
ART. NO. 727716	S10
ART. NO. 727719	S10



6 DRAWERS FILLED WITH 277-PCS TOOLS

FOR DETAILS ABOUT THE SPECIFICATIONS OF THE TOOL BOX, SEE CHAPTER EMPTY STORAGE SYSTEMS

FOR DETAILS ABOUT THE CONTENTS OF THE TOOL BOX, SEE CHAPTER TOOLS SETS

i MORE INFO WWW.SONIC-EQUIPMENT.COM

1 602407

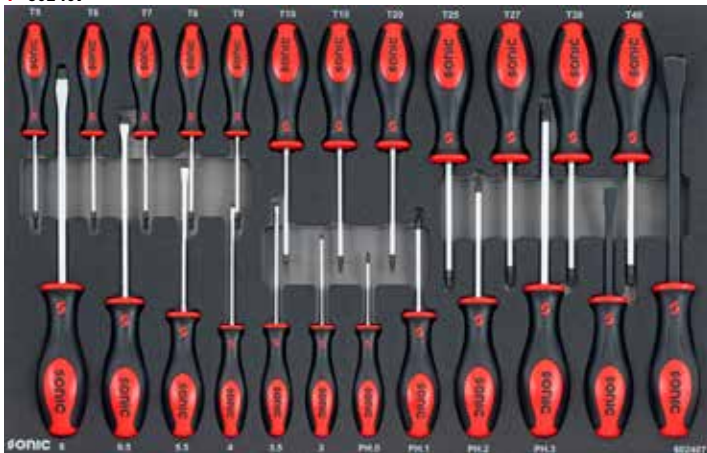

2 313902



3 604002

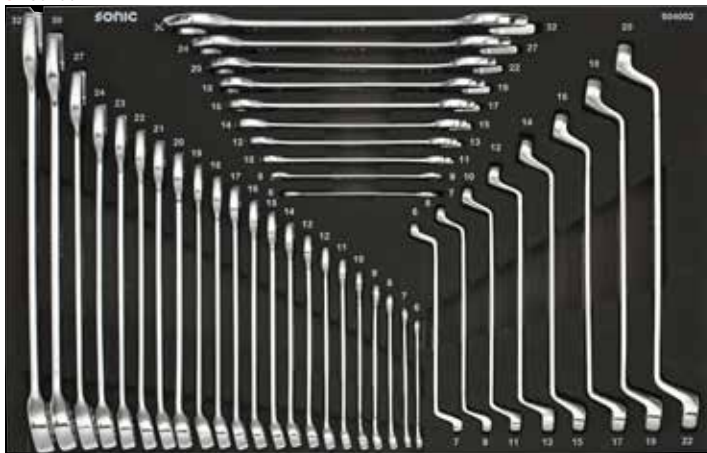

4 603003



5 602302



6 602104



302-PCS

ART. NO. 730231	S9
ART. NO. 730209	S10
ART. NO. 730215	S10
ART. NO. 730216	S10
ART. NO. 730219	S10



6 DRAWERS FILLED WITH 302-PCS TOOLS

FOR DETAILS ABOUT THE SPECIFICATIONS OF THE TOOL BOX, SEE CHAPTER EMPTY STORAGE SYSTEMS

FOR DETAILS ABOUT THE CONTENTS OF THE TOOL BOX, SEE CHAPTER TOOLS SETS

i MORE INFO WWW.SONIC-EQUIPMENT.COM



ART. NO. 733831	S9
ART. NO. 733809	S10
ART. NO. 733815	S10
ART. NO. 733816	S10
ART. NO. 733819	S10



7 DRAWERS FILLED WITH 339-PCS TOOLS

FOR DETAILS ABOUT THE SPECIFICATIONS OF THE TOOL BOX, SEE CHAPTER EMPTY STORAGE SYSTEMS

FOR DETAILS ABOUT THE CONTENTS OF THE TOOL BOX, SEE CHAPTER TOOLS SETS

WWW.SONIC-EQUIPMENT.COM



369-PCS

ART. NO. 736931



6 DRAWERS FILLED WITH 369-PCS TOOLS

FOR DETAILS ABOUT THE SPECIFICATIONS OF THE TOOL BOX, SEE CHAPTER EMPTY STORAGE SYSTEMS

FOR DETAILS ABOUT THE CONTENTS OF THE TOOL BOX, SEE CHAPTER TOOLS SETS

i MORE INFO WWW.SONIC-EQUIPMENT.COM

1 602407

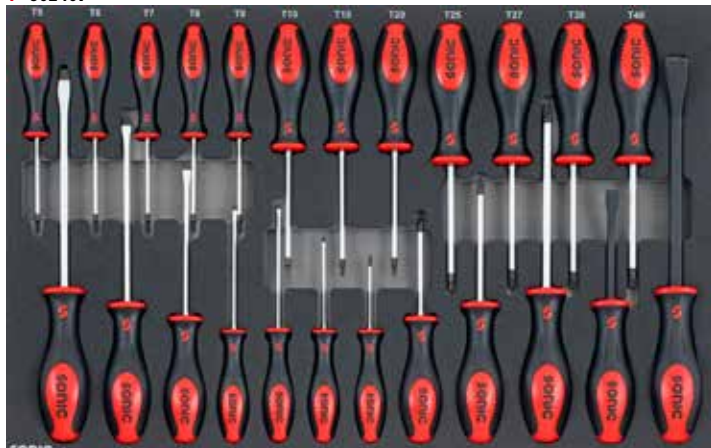

2 215702



3 309502



4 604002

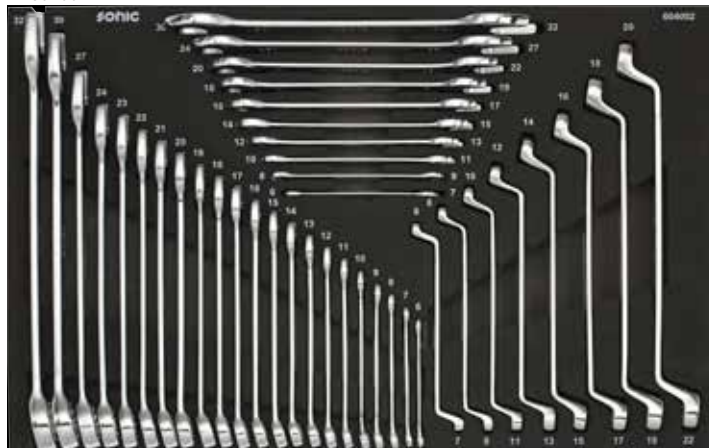

5 603003



6 602302



378-PCS

1 604102



2 311101



3 310501



ART. NO. 737731	S9
ART. NO. 737709	S10
ART. NO. 737715	S10
ART. NO. 737716	S10
ART. NO. 737719	S10



7 DRAWERS FILLED WITH 378-PCS TOOLS

FOR DETAILS ABOUT THE SPECIFICATIONS OF THE TOOL BOX, SEE CHAPTER EMPTY STORAGE SYSTEMS.

FOR DETAILS ABOUT THE CONTENTS OF THE TOOL BOX, SEE CHAPTER TOOLS SETS

i MORE INFO WWW.SONIC-EQUIPMENT.COM

4 603903

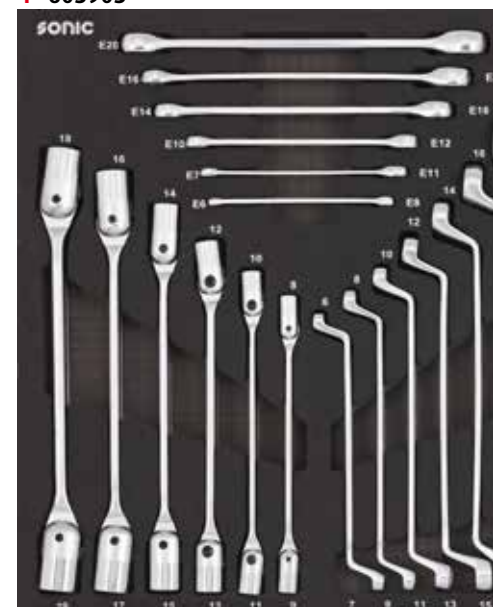



5 604301



6 601802



7 602103

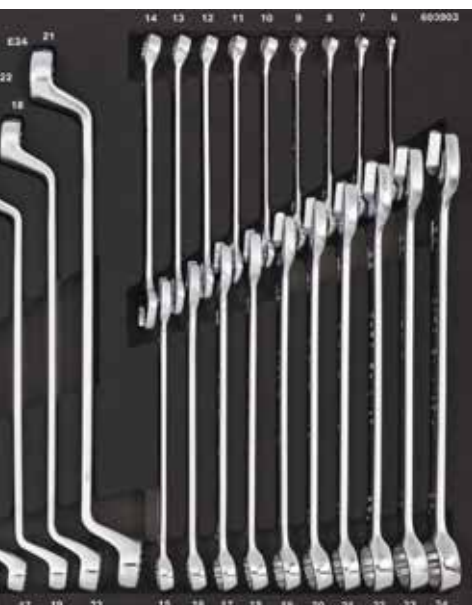

ART. NO. 733931	S9
ART. NO. 733909	S10
ART. NO. 733915	S10
ART. NO. 733916	S10
ART. NO. 733919	S10



5 DRAWERS FILLED WITH 339-PCS TOOLS

FOR DETAILS ABOUT THE SPECIFICATIONS OF THE TOOL BOX, SEE CHAPTER EMPTY STORAGE SYSTEMS

FOR DETAILS ABOUT THE CONTENTS OF THE TOOL BOX, SEE CHAPTER TOOLS SETS

i MORE INFO WWW.SONIC-EQUIPMENT.COM

1 602407

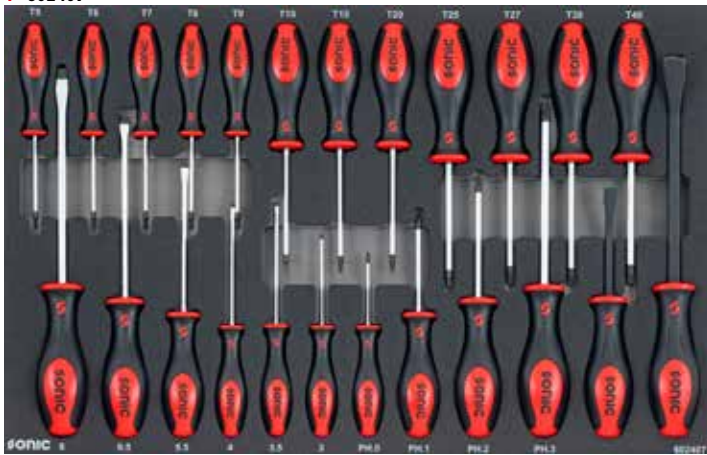

2 215702



3 309502



4 604002

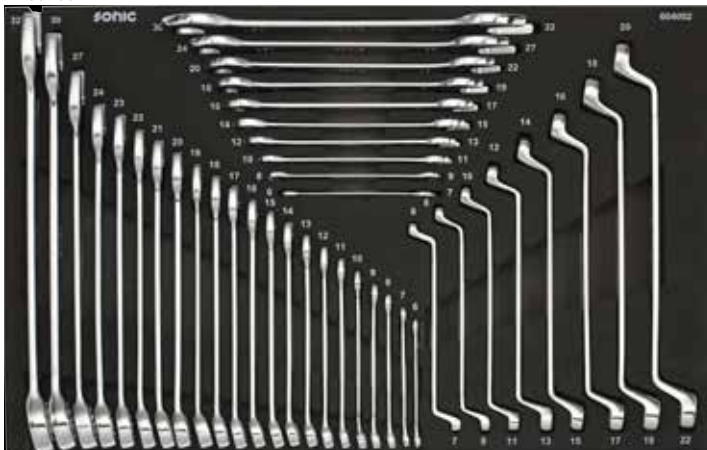

5 602302



391-PCS

ART. NO. 739131	S9
ART. NO. 739009	S10
ART. NO. 739015	S10
ART. NO. 739016	S10
ART. NO. 739019	S10



1 602407

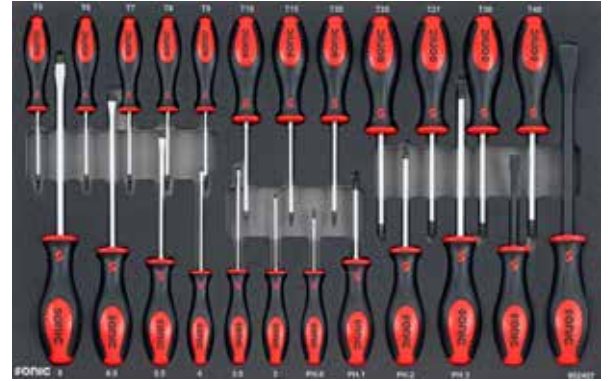

3 309502



5 604702



7 601601

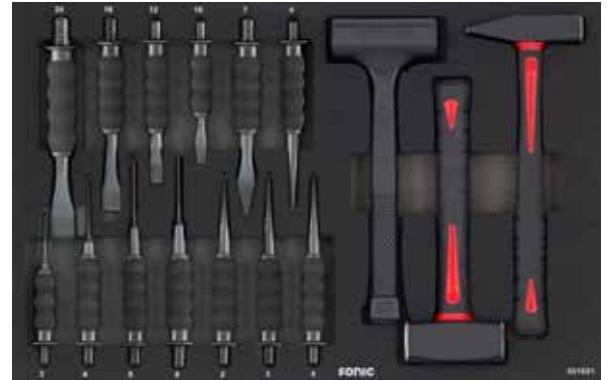

2 215702



4 604002

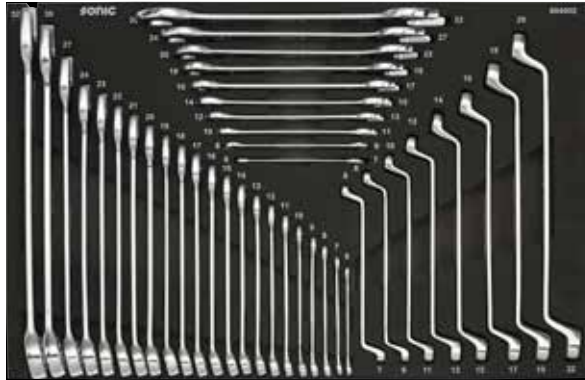

6 601207

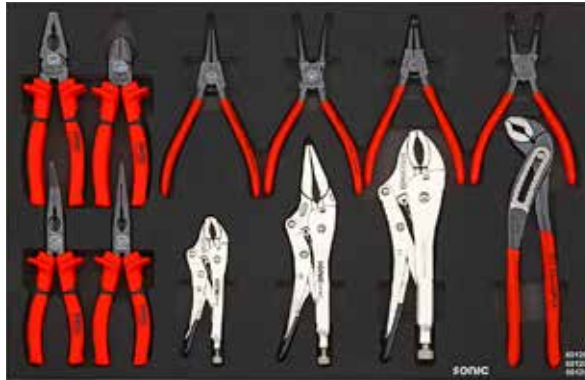

7 DRAWERS FILLED WITH 391-PCS TOOLS

FOR DETAILS ABOUT THE SPECIFICATIONS OF THE TOOL BOX, SEE CHAPTER EMPTY STORAGE SYSTEMS

FOR DETAILS ABOUT THE CONTENTS OF THE TOOL BOX, SEE CHAPTER TOOLS SETS

WWW.SONIC-EQUIPMENT.COM

ART. NO. 746009
ART. NO. 746015
ART. NO. 746016
ART. NO. 746019



HEAVY DUTY

8 DRAWERS FILLED WITH 460-PCS TOOLS

FOR DETAILS ABOUT THE SPECIFICATIONS OF THE TOOL BOX, SEE CHAPTER EMPTY STORAGE SYSTEMS

FOR DETAILS ABOUT THE CONTENTS OF THE TOOL BOX, SEE CHAPTER TOOLS SETS

WWW.SONIC-EQUIPMENT.COM

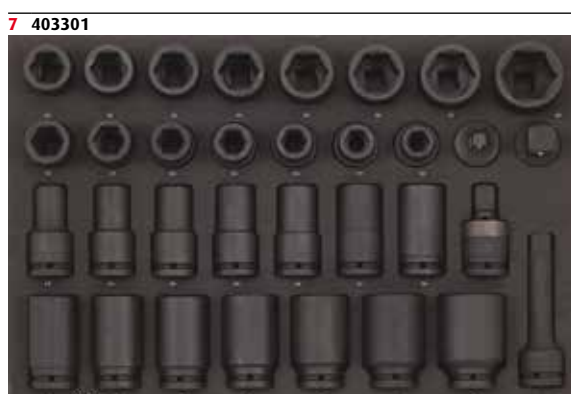
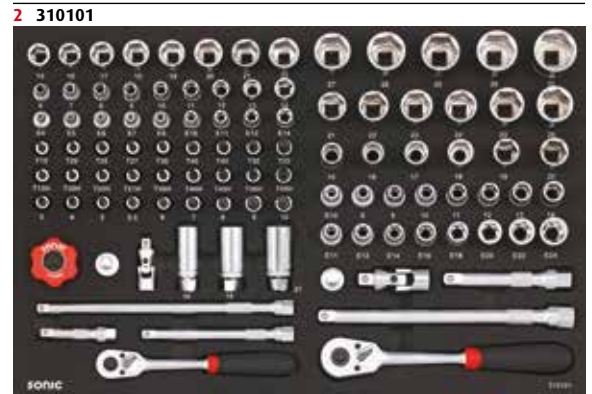

471-PCS



ART. NO. 747131	S9
ART. NO. 747109	S10
ART. NO. 747115	S10
ART. NO. 747116	S10
ART. NO. 747119	S10



7 DRAWERS FILLED WITH 471-PCS TOOLS

FOR DETAILS ABOUT THE SPECIFICATIONS OF THE TOOL BOX, SEE CHAPTER EMPTY STORAGE SYSTEMS

FOR DETAILS ABOUT THE CONTENTS OF THE TOOL BOX, SEE CHAPTER TOOLS SETS

WWW.SONIC-EQUIPMENT.COM



ART. NO. 752731	S9
ART. NO. 752709	S10
ART. NO. 752715	S10
ART. NO. 752716	S10
ART. NO. 752719	S10



8 DRAWERS FILLED WITH 527-PCS TOOLS

FOR DETAILS ABOUT THE SPECIFICATIONS OF THE TOOL BOX, SEE CHAPTER EMPTY STORAGE SYSTEMS

FOR DETAILS ABOUT THE CONTENTS OF THE TOOL BOX, SEE CHAPTER TOOLS SETS

WWW.SONIC-EQUIPMENT.COM



539-PCS

ART. NO. 753931	S9
ART. NO. 753909	S10
ART. NO. 753915	S10
ART. NO. 753916	S10
ART. NO. 753919	S10



8 DRAWERS FILLED WITH 539-PCS TOOLS

FOR DETAILS ABOUT THE SPECIFICATIONS OF THE TOOL BOX, SEE CHAPTER EMPTY STORAGE SYSTEMS

FOR DETAILS ABOUT THE CONTENTS OF THE TOOL BOX, SEE CHAPTER TOOLS SETS

WWW.SONIC-EQUIPMENT.COM



ART. NO. 729509
ART. NO. 729515
ART. NO. 729516
ART. NO. 729519

TOOL BOX
SPECIALLY ASSEMBLED
FOR VOLKSWAGEN
AND AUDI



**5 DRAWERS FILLED
WITH 295-PCS TOOLS**

MAIN FEATURES

- 8 DRAWERS;
- 7 SHALLOW DRAWERS
- 1 DEEP DRAWER
- DRAWER BLOCKING SYSTEM, AS PROTECTION AGAINST TIPPING OVER
- DRAWER RELEASE SYSTEM, NO MECHANISM IN THE HANDLE
- 100% RETRACTABLE DRAWERS
- AUTO RETURN BALL BEARING SLIDES
- POWDER COATING EXTERIOR
- FRONT CENTRALIZED SAFETY LOCK
- FOLDING KEY
- ABS TOPBLADE
- INTEGRATED CAN HOLDERS
- INTEGRATED PAPER ROLL HOLDER
- INTEGRATED GARBAGE BIN
- 4 EXTRA LARGE WHEELS Ø125MM, WHEREOF 2 CASTERS WITH ROLLING AND TURNING BRAKE
- OVERALL WEIGHT 91KG
- STATIC LOAD CAPACITY: 400KG
- DRAWER CAPACITY: 40KG



1 603506

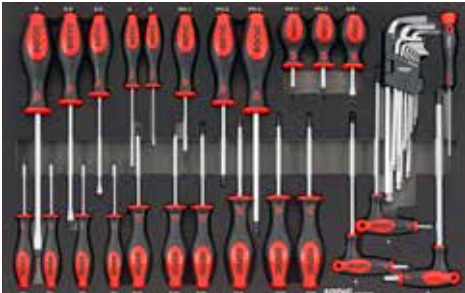

2 213901



3 306101



WORK EFFICIENT
WORK WITH SONIC

4 603701



5 602304



1 603505

SFS 35-PCS SCREWDRIVER SET

ART. NO.	CONTENTS
1311...3	3 SCREWDRIVER PH.1, PH.2, PH.3
13115...25	2 SCREWDRIVER, STUBBY PH.1, PH.2
13303...8	5 SCREWDRIVER, SLOTTED 3, 4, 5.5, 6.5, 8MM
1330555	1 SCREWDRIVER, STUBBY SLOTTED 5.5MM
13606...30	10 SCREWDRIVER, TX T6, T7, T8, T9, T10, T15, T20, T25, T27, T30
1950205...08	3 T-HANDLE BALL ENDED HEXAGON KEY WRENCH, EXTRA LONG 5, 6, 8MM
17320002	1 ELECTRONIC SCREWDRIVER 2MM
601008	10 HEX BALL EXTRA LONG KEY SET 10-PCS

2 213901

SFS 139-PCS SCREWDRIVER SET

ART. NO.	CONTENTS
21505...14	12 FLANK SOCKET 1/4", 6 PT. 4.5, 5, 5.5, 6, 7, 8, 9, 10, 11, 12, 13, 14MM
600902	9 TX WRENCH, EXTRA LONG KEY SET 9-PCS
7110101	1 FLEXIBLE RATCHET 1/4" 45 TEETH
7120901	1 RATCHET HANDLE 1/4" 45 TEETH
7131115	1 SLIDING T HANDLE 1/4"
7141050...150	2 EXTENSION 1/4" 50, 150MML
71511	1 UNIVERSAL JOINT 1/4"
72401	1 SPINNER 1/4" 150MML
72225	1 MAGNET SOCKET PICK-UP 1/4"
8113700...03	4 BIT SOCKET PH 1/4", PH.0, PH.1, PH.2, PH.3
8133704...65	3 BIT SOCKET SLOTTED 1/4", 4, 5.5, 6.5MM
8143703...08	6 BIT SOCKET HEX 1/4", 3, 4, 5, 6, 7, 8MM
8153710...40	7 TAMPER-RESISTANT 1/4", TX PLUS (5 LOBES) 10IPR, 15IPR, 20IPR, 25IPR, 27IPR, 30IPR, 40IPR
8163706...40	11 BIT SOCKET TX 1/4", T6, T7, T8, T9, T10, T15, T20, T25, T27, T30, T40
8183704...10	5 BIT SOCKET SPLINE 1/4", M4, M5, M6, M8, M10
22506...22	17 FLANK SOCKET 3/8", 6 PT. 6, 7, 8, 9, 10, 11, 12, 13, 14, 15, 16, 17, 18, 19, 20, 21, 22MM
22604...14	9 SOCKET 3/8", TX E4, E5, E6, E7, E8, E10, E11, E12, E14
7110102	1 FLEXIBLE RATCHET 3/8" 45 TEETH
7120902	1 RATCHET HANDLE 3/8" 45 TEETH
7142044...250	4 EXTENSION 3/8" 44, 75, 150, 250MML
71521	1 UNIVERSAL JOINT 3/8"
7172216...21	3 SPARK PLUG 3/8" CLIP SOCKET 16, 18, 21MM
8244803...10	9 BIT SOCKET HEX 3/8", 3, 4, 5, 5.5, 6, 7, 8, 9, 10MM
8264815...55	9 BIT SOCKET TX 3/8", T15, T20, T25, T27, T30, T40, T45, T50, T55
8274815...55	9 BIT SOCKET TX TAMPERPROOF 3/8", T15H, T20H, T25H, T27H, T30H, T40H, T45H, T50H, T55H
8284804...12	7 BIT SOCKET SPLINE 3/8", M4, M5, M6, M8, M9, M10, M12
4160608...2024	4 TX WRENCH E6XE8, E10XE12, E14XE18, E20XE24

3 306101

SFS 61-PCS 1/2" SET

ART. NO.	CONTENTS
23510...32	19 FLANK SOCKET 1/2", 6 PT. 10, 11, 12, 13, 14, 15, 16, 17, 18, 19, 20, 21, 22, 24, 26, 27, 28, 30, 32
23809...13	3 SOCKET 1/2", 12 PT. 9, 10, 13
3310117...19	2 WHEEL SOCKET 1/2", 6PT. 17, 19MM
7120903	1 RATCHET HANDLE 1/2" 45 TEETH
7133250	1 SLIDING T HANDLE 1/2" 250MML
7143125...250	2 EXTENSION 1/2" 125MML, 250MML
7263050...250	3 WOBBLE EXTENSION 1/2" 50MML, 125MML, 250MML
71531	1 UNIVERSAL JOINT 1/2"
71623	1 ADAPTOR FOR EXTENSION 3/8"(F) X 1/2"(M)
83010005...10	6 BIT SOCKET HEX BALL 1/2", 5, 6, 7, 8, 9, 10MM
83410006...08	2 BIT SOCKET HEX 1/2", 100MML 6, 8MM
83414010	1 BIT SOCKET HEX 1/2", 140MML 10MM
83424806	1 BIT SOCKET HEX 1/2", 248MML 6MM
83606245...60	4 BIT SOCKET TX 1/2", T45, T50, T55, T60
83610045	1 BIT SOCKET TX 1/2", 100MML T45
83806208...14	5 BIT SOCKET SPLINE 1/2", M8, M9, M10, M12, M14
83806216T	1 BIT SOCKET SPLINE 1/2", M16-T
83810008...14	4 BIT SOCKET SPLINE 1/2", 100MML M8, M10, M12, M14
83910009	1 BIT SOCKET RIBE 1/2", 100MML M9
24934	1 SOCKET 3/4", 12 PT. 34MM
87810518	1 BIT SOCKET IMPACT SPLINE 3/4", M18

4 603701

SFS 37-PCS WRENCH SET

ART. NO.	CONTENTS
41506...22	17 COMBINATION WRENCH 6, 7, 8, 9, 10, 11, 12, 13, 14, 15, 16, 17, 18, 19, 20, 21, 22MM
4140607...3032	10 DOUBLE OPEN WRENCH 6X7, 8X9, 10X11, 12X13, 14X15, 16X17, 18X19, 20X22, 24X27, 30X32MM
4190607...2022	8 75 OFFSET RING WRENCH 6X7, 8X9, 10X11, 12X13, 14X15, 16X17, 18X19, 20X22MM
4200113	1 INJECTION PUMP WRENCH 13MM
40811	1 FLEXIBLE FLARE NUT WRENCH 11MM

5 602304

SFS 23-PCS PLIER SET

ART. NO.	CONTENTS
4311175	1 COMBINATION PLIERS 7"
4321200	1 LONG NOSE PLIERS 8"
4341175	1 DIAGONAL PLIERS 7"
4351250	1 WATERPUMP PLIERS 10"
4380250	1 LOCKING PLIERS 10"
43613	1 SNAP RING PLIERS (BENT-OPEN)
447101	1 AUTOMATIC WIRE STRIPPER 0.5-4MM
4471250	1 WIRE STRIPPER 10"
45116170...18190	2 GRIP CHISEL 170MML 16, 190MML 18
4527190	1 GRIP CAPE CHISEL 190MML 7
4532140...8220	6 GRIP PIN PUNCH 140MML 2, 150MML 3, 180MML 4, 200MML 5, 210MML 6, 220MML 8
4564185	1 GRIP CENTER PUNCH 185MML 4
4611400	1 MACHINIST HAMMER 400GR FIBRE HANDLE TPR COVER
4620400	1 SAND FILLED HAMMER 400GR
47903	1 SCRAPER
4811254	1 STEEL BRUSH
4821301	1 WEDGE UNIVERSAL 190X30MM

ART. NO. 732809
ART. NO. 732815
ART. NO. 732816
ART. NO. 732819

TOOL BOX
SPECIALLY
ASSEMBLED
FOR BMW



**6 DRAWERS FILLED
WITH 328-PCS TOOLS**

MAIN FEATURES

- 8 DRAWERS;
- 7 SHALLOW DRAWERS
- 1 DEEP DRAWER
- DRAWER BLOCKING SYSTEM, AS PROTECTION AGAINST TIPPING OVER
- DRAWER RELEASE SYSTEM, NO MECHANISM IN THE HANDLE
- 100% RETRACTABLE DRAWERS
- AUTO RETURN BALL BEARING SLIDES
- POWDER COATING EXTERIOR
- FRONT CENTRALIZED SAFETY LOCK
- FOLDING KEY
- ABS TOPBLADE
- INTEGRATED CAN HOLDERS
- INTEGRATED PAPER ROLL HOLDER
- INTEGRATED GARBAGE BIN
- 4 EXTRA LARGE WHEELS Ø125MM, WHEREOF 2 CASTERS WITH ROLLING AND TURNING BRAKE
- OVERALL WEIGHT 91KG
- STATIC LOAD CAPACITY: 400KG
- DRAWER CAPACITY: 40KG



1 602708



2 214201



3 306601



4 604101



5 603601



6 601706



1 602704

SFS 27-PCS SCREWDRIVER SET

ART. NO.	CONTENTS
1311...13	3 SCREWDRIVER PH.1, PH.2, PH.3
13115	1 SCREWDRIVER, STUBBY PH.1
1321...23	3 SCREWDRIVER PZ.1, PZ.2, PZ.3
13215	1 SCREWDRIVER, STUBBY PZ.1
13303...08	5 SCREWDRIVER, SLOTTED 3, 4, 5.5, 6.5, 8MM
1330555	1 SCREWDRIVER, STUBBY SLOTTED 5.5MM
13606...40	11 SCREWDRIVER, TX T6, T7, T8, T9, T10, T15, T20, T25, T27, T30, T40
47536...07	2 FLEXIBLE SOCKET SCREWDRIVER, HEX 6, 7MM

2 214201

SFS 142-PCS 1/4" & 3/8" SET

ART. NO.	CONTENTS
21503...14	12 FLANK SOCKET 1/4", 6 PT. 3, 5, 5.5, 6, 7, 8, 9, 10, 11, 12, 13, 14MM
2155004...13	12 FLANK DEEP SOCKET 1/4", 6 PT. 4, 4.5, 5, 5.5, 6, 7, 8, 9, 10, 11, 12, 13MM
21604...10	6 SOCKET 1/4", TX, E5, E6, E7, E8, E10
7110102	1 FLEXIBLE RATCHET 3/8", 45 TEETH
7120901	1 RATCHET HANDLE 1/4", 45 TEETH
7131115	1 SLIDING T HANDLE 1/4"
71511	1 UNIVERSAL JOINT 1/4"
71521	1 UNIVERSAL JOINT 3/8"
7141050...150	3 EXTENSION 1/4" 50, 100, 150MML
7261250	1 WOBBLE EXTENSION 1/4" 250MML
7151608	1 CARDAN SOCKET 1/4", TX E8
71912	1 ADAPTOR 1/4"(F) X 3/8"(M)
72225	1 MAGNET SOCKET PICK-UP 1/4"P
72401	1 SPINNER 1/4" 150MML
8113701...03	3 BIT SOCKET PH 1/4", PH.1, PH.2, PH.3
8133704...065	3 BIT SOCKET SLOTTED 1/4", 4, 5.5, 6.5MM
8143703...08	5 BIT SOCKET HEX 1/4", 3, 4, 5, 6, 8MM
8163710...40	7 BIT SOCKET TX 1/4", T10, T15, T20, T25, T27, T30, T40
22507...22	16 FLANK SOCKET 3/8", 6 PT. 7, 8, 9, 10, 11, 12, 13, 14, 15, 16, 17, 18, 19, 20, 21, 22MM
2256308...21	14 FLANK SOCKET 3/8", 6 PT. DEEP 8, 9, 10, 11, 12, 13, 14, 15, 16, 17, 18, 19, 20, 21MM
22605...14	8 SOCKET 3/8", TX E5, E6, E7, E8, E10, E11, E12, E14
7120902	1 RATCHET HANDLE 3/8" 45 TEETH
7142075...250	3 EXTENSION 3/8" 75, 150, 250MML
7152610	1 TX CARDAN 3/8" SOCKET E10
7152810...16	7 CARDAN SOCKET 3/8", 10, 11, 12, 13, 14, 15, 16MM
71921	1 ADAPTOR 3/8"(F) X 1/4"(M)
71932	1 ADAPTOR 1/2"(F) X 3/8"(M)
7172216...21	3 SPARK PLUG 3/8" CLIP SOCKET 16, 18, 21MM
8244803...10	9 BIT SOCKET HEX 3/8", 3, 4, 5, 5.5, 6, 7, 8, 9, 10MM
8264815...55	9 BIT SOCKET TX 3/8", T15, T20, T25, T27, T30, T40, T45, T50, T55
8269025	1 BIT SOCKET TX 3/8", 90MML T25
8284804...12	7 BIT SOCKET SPLINE 3/8", M4, M5, M6, M8, M9, M10, M12

3 306601

SFS 66-PCS 1/2" SET

ART. NO.	CONTENTS
23510...32	19 FLANK SOCKET 1/2", 6 PT. 10, 11, 12, 13, 14, 15, 16, 17, 18, 19, 20, 21, 22, 24, 26, 27, 28, 30, 32MM
23610...24	9 SOCKET 1/2", TX E10, E11, E12, E14, E16, E18, E20, E22, E24
3310117...19	2 WHEEL SOCKET 1/2", 6PT. 17, 19MM
4160608...2024	4 TX WRENCH E6XE8, E10XE12, E14XE18, E20XE24
7120903	1 RATCHET HANDLE 1/2" 45 TEETH
7133250	1 SLIDING T HANDLE 1/2" 250MML
7143125...250	2 EXTENSION 1/2" 125MML, 250MML
71531	1 UNIVERSAL JOINT 1/2"
71923	1 ADAPTOR 3/8"(F) X 1/2"(M)
71932	1 ADAPTOR 1/2"(F) X 3/8"(M)
7263050...500	2 WOBBLE EXTENSION 1/2" 50, 500MML
7273380	1 SWIVEL GRIP HANDLE 1/2" 380MML
83406206...19	9 BIT SOCKET HEX 1/2", 6, 7, 8, 9, 10, 12, 14, 17, 19MM
83606220...60	9 BIT SOCKET TX 1/2", T20, T25, T27, T30, T40, T45, T50, T55, T60
83706230...50	4 BIT SOCKET TAMPERPROOF 1/2", TX T30H, T40H, T45H, T50H

4 604101

SFS 41-PCS WRENCH SET

ART. NO.	CONTENTS
4110810...1113	2 FLARE NUT WRENCH 8X10, 11X13MM
4140607...2427	10 DOUBLE OPEN WRENCH 6X7, 8X9, 10X11, 12X13, 14X15, 16X17, 18X19, 20X22, 21X23, 24X27MM
41506...32	20 COMBINATION WRENCH 6, 7, 8, 9, 10, 11, 12, 13, 14, 15, 16, 17, 18, 19, 21, 22, 24, 27, 30, 32MM
4190607...2123	9 75 OFFSET RING WRENCH 6X7, 8X9, 10X11, 12X13, 14X15, 16X17, 18X19, 20X22, 21X23MM

5 603601

SFS 36-PCS PLIER SET

ART. NO.	CONTENTS
4311175	1 COMBINATION PLIERS 7"
4321200	1 LONG NOSE PLIERS 8"
4341175	1 DIAGONAL PLIERS 7"
4351250	1 WATERPUMP PLIERS 10"
43611	1 SNAP RING PLIERS (STRAIGHT-OPEN)
43612	1 SNAP RING PLIERS (STRAIGHT-CLOSE)
43613	1 SNAP RING PLIERS (BENT-OPEN)
43614	1 SNAP RING PLIERS (BENT-CLOSE)
4380250	1 LOCKING PLIERS 10"
46802	1 UTILITY KNIFE ZINC ALLOY (INCL. 6PC BLADES)
4820110	1 MAGNET PICKUP 10LBS.
4821105	1 FLASH PEN
4820207	1 FLEXIBLE MAGNET PICKUP 500GR-400L
600902	9 TX WRENCH, EXTRA LONG KEY SET 9-PCS
601006	10 HEX BALL LONG KEY SET 10-PCS
1860106...09	4 STAR EXTRA LONG KEY T6, T7, T8, T9

6 601706

SFS 17-PCS CHISEL & HAMMER SET

ART. NO.	CONTENTS
45118190...24220	2 GRIP CHISEL 190MML 18, 220MML 24
4527190	1 GRIP CAPE CHISEL 190MML 7
4533150...8220	5 GRIP PIN PUNCH 150MML 3, 180MML 4, 200MML 5, 210MML 6, 220MML 8
4564185	1 GRIP CENTER PUNCH 185MML 4
4611400	1 MACHINIST HAMMER 400GR FIBRE HANDLE TPR COVER
4620400	1 SAND FILLED HAMMER 400GR
47013	1 MEASURING TAPE 5 METER
47019	1 VOLT CIRCUIT TESTER
47903	1 SCRAPER
4811254	1 STEEL WIRE BRUSH
4821301	1 WEDGE UNIVERSAL 190X30MM
48212380	1 PRY BAR 380MM

ART. NR. 727409
ART. NR. 727415
ART. NR. 727416
ART. NR. 727419

TOOL BOX
SPECIALLY
ASSEMBLED FOR
MERCEDES BENZ



**6 DRAWERS FILLED
WITH 274-PCS TOOLS**

MAIN FEATURES

- 8 DRAWERS;
- 7 SHALLOW DRAWERS
- 1 DEEP DRAWER
- DRAWER BLOCKING SYSTEM, AS PROTECTION AGAINST TIPPING OVER
- DRAWER RELEASE SYSTEM, NO MECHANISM IN THE HANDLE
- 100% RETRACTABLE DRAWERS
- AUTO RETURN BALL BEARING SLIDES
- POWDER COATING EXTERIOR
- FRONT CENTRALIZED SAFETY LOCK
- FOLDING KEY
- ABS TOPBLADE
- INTEGRATED CAN HOLDERS
- INTEGRATED PAPER ROLL HOLDER
- INTEGRATED GARBAGE BIN
- 4 EXTRA LARGE WHEELS Ø125MM, WHEREOF 2 CASTERS WITH ROLLING AND TURNING BRAKE
- OVERALL WEIGHT 91KG
- STATIC LOAD CAPACITY: 400KG
- DRAWER CAPACITY: 40KG

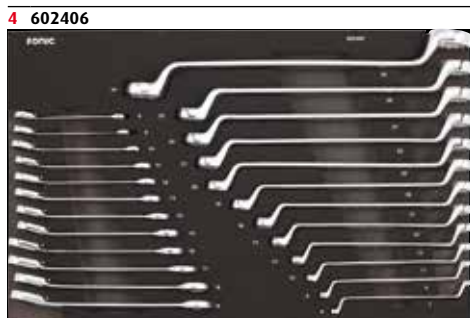
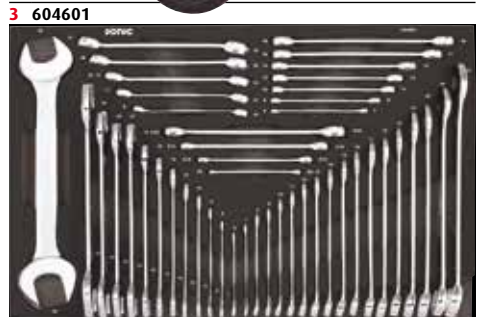
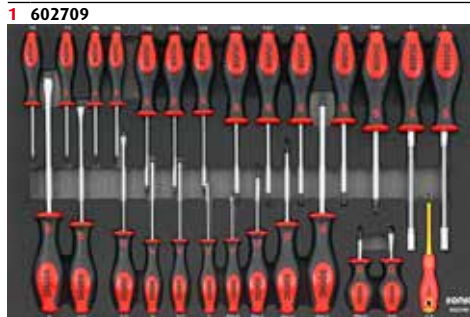

1 602705

SFS 27-PCS SCREWDRIVER SET	
ART. NO.	CONTENTS
1310...3	4 SCREWDRIVER, PH.0, PH.1, PH.2, PH.3
13125	1 SCREWDRIVER, STUBBY PH.2
13303...8	6 SCREWDRIVER, SLOTTED 3, 3.5, 4, 5.5, 6.5, 8
1330555	1 SCREWDRIVER, STUBBY SLOTTED 5.5MM
16325	1 VDE SCREWDRIVER, SLOTTED 2.5MM
13606...45	12 SCREWDRIVER, TX T6, T7, T8, T9, T10, T15, T20, T25, T27, T30, T40, T45
47537...08	2 FLEXIBLE SOCKET SCREWDRIVER, HEX 7, 8MM

2 313802

SFS 138-PCS 1/4" & 1/2" SET	
ART. NO.	CONTENTS
21504...14	12 FLANK SOCKET 1/4", 6 PT. 4, 5, 5.5, 6, 7, 8, 9, 10, 11, 12, 13, 14MM
21604...10	6 SOCKET 1/4", TX E4, E5, E6, E7, E8, E10
23510...32	21 FLANK SOCKET 1/2", 6 PT. 10, 11, 12, 13, 14, 15, 16, 17, 18, 19, 20, 21, 22, 23, 24, 25, 26, 27, 28, 30, 32MM
23611...24	7 SOCKET 1/2", TX E11, E12, E14, E16, E18, E20, E24
24936	1 SOCKET 3/4", 12 PT. 36MM
3310117...19	2 WHEEL SOCKET 1/2", 6PT. 17, 19MM
1860106...09	4 KEY WRENCH TX, EXTRA LONG T6, T7, T8, T9
600902	9 TX WRENCH, EXTRA LONG KEY SET 9-PCS
601008	10 HEX BALL EXTRA LONG KEY SET 10-PCS
7120901	1 RATCHET HANDLE 1/4" 45 TEETH
7131115	1 SLIDING T HANDLE 1/4"
7141050...150	2 EXTENSION 1/4" 50, 150MML
71511	1 UNIVERSAL JOINT 1/4"
72401	1 SPINNER 1/4" 150MML
7120903	1 RATCHET HANDLE 1/2" 45 TEETH
7133250	1 SLIDING T HANDLE 1/2" 250MML
7143125...250	2 EXTENSION 1/2" 125, 250MML
71531	1 UNIVERSAL JOINT 1/2"
71934	1 ADAPTOR 1/2"(F)X 3/4"(M)
8113701...03	3 BIT SOCKET PH 1/4", PH.1, PH.2, PH.3
8123701...02	2 BIT SOCKET PZ 1/4", PZ.1, PZ.2
8133704...65	3 BIT SOCKET SLOTTED 1/4", 4, 5.5, 6.5MM
8143703...08	6 BIT SOCKET HEX 1/4", 3, 4, 5, 6, 7, 8MM
8163706...40	11 BIT SOCKET TX 1/4", T6, T7, T8, T9, T10, T15, T20, T25, T27, T30, T40
8173706...40	11 BIT SOCKET TX TAMPERPROOF 1/4", T6H, T7H, T8H, T9H, T10H, T15H, T20H, T25H, T27H, T30H, T40H
83406205...19	9 BIT SOCKET HEX 1/2", 5, 6, 7, 8, 10, 12, 14, 17, 19MM
83606240...60	5 BIT SOCKET TX 1/2", T40, T45, T50, T55, T60
83610025	1 BIT SOCKET TX 1/2", 100MML T25
83806206...10	3 BIT SOCKET SPLINE 1/2", M6, M8, M10

3 604601

SFS 46-PCS WRENCH SET	
ART. NO.	CONTENTS
4110810...1719	5 FLARE NUT WRENCH 8X10, 11X13, 12X14, 16X18, 17X19MM
4140607...3436	12 DOUBLE OPEN WRENCH 6X7, 8X9, 10X11, 12X13, 14X15, 16X17, 18X19, 21X23, 22X24, 24X27, 30X32, 34X36MM
41506...27	18 COMBINATION WRENCH 6, 7, 8, 9, 10, 11, 12, 13, 14, 15, 16, 17, 18, 19, 21, 22, 24, 27MM
4160608...2024	4 TX WRENCH E6XE8, E10XE12, E14XE18, E20XE24
4200607...1819	7 FLAT DOUBLE RING WRENCH 6X7, 8X9, 10X11, 12X13, 14X15, 16X17, 18X19MM

4 602406

SFS 24-PCS WRENCH SET	
ART. NO.	CONTENTS
4170208...19	12 REVERSIBLE RATCHETING WRENCH 8, 9, 10, 11, 12, 13, 14, 15, 16, 17, 18, 19MM
4190607...3436	12 75 OFFSET RING WRENCH 6X7, 8X9, 10X11, 12X13, 14X15, 16X17, 18X19, 20X22, 21X23, 24X27, 25X28, 34X36MM

5 601802

SFS 18-PCS PLIER SET	
ART. NO.	CONTENTS
4311175	1 COMBINATION PLIERS 7"
4321200	1 LONG NOSE PLIERS 8"
4331200	1 BENT LONG NOSE PLIERS 8"
4341175	1 DIAGONAL PLIERS 7"
4351250	1 WATERPUMP PLIERS 10"
43611	1 SNAP RING PLIERS (STRAIGHT-OPEN)
43612	1 SNAP RING PLIERS (STRAIGHT-CLOSE)
43613	1 SNAP RING PLIERS (BENT-OPEN)
43614	1 SNAP RING PLIERS (BENT-CLOSE)
4380250	1 LOCKING PLIERS 10"
46802	1 UTILITY KNIFE ZINC ALLOY (INCL. 6PC BLADES)
46911	1 FLAT FILE 8"
46912	1 HALF ROUND FILE 8"
46913	1 ROUND FILE 8"
46914	1 TRIANGULAR FILE 8"
47002	1 26PCS FEELER GAUGE
47003	1 VERNIER CALIPER
47013	1 MEASURING TAPE 5 METER

6 602103

SFS 21-PCS CHISEL & HAMMER SET	
ART. NO.	CONTENTS
45118190...24220	2 GRIP CHISEL 190MML 18, 220MML 24
4527190	1 GRIP CAPE CHISEL 190MML 7
4533150...8220	5 GRIP PIN PUNCH 150MML 3, 180MML 4, 200MML 5, 210MML 6, 220MML 8
4552185...4185	3 GRIP TAPER PUNCH 185MML 2, 3, 4
4564185	1 GRIP CENTER PUNCH 185MML 4
4611400	1 MACHINIST HAMMER 400GR FIBRE HANDLE TPR COVER
4620400	1 SAND FILLED HAMMER 400GR
4631000	1 STONING HAMMER 1000GR FIBRE HANDLE TPR COVER
47903	1 SCRAPER
4820110	1 MAGNET PICKUP 10LBS.
4811254	1 STEEL BRUSH
4821301	1 WEDGE UNIVERSAL 190X30MM
48212380	1 PRY BAR 380MM
4820207	1 FLEXIBLE MAGNET PICKUP 500GR-400L

345-PCS



ART. NO. 734529	S12
ART. NO. 734511	S11
ART. NO. 734517	S11
ART. NO. 734518	S11
ART. NO. 734520	S11



6 DRAWERS FILLED WITH 345-PCS TOOLS

FOR DETAILS ABOUT THE SPECIFICATIONS OF THE TOOL BOX, SEE CHAPTER EMPTY STORAGE SYSTEMS

FOR DETAILS ABOUT THE CONTENTS OF THE TOOL BOX, SEE CHAPTER TOOLS SETS

1 MORE INFO WWW.SONIC-EQUIPMENT.COM

1 603202

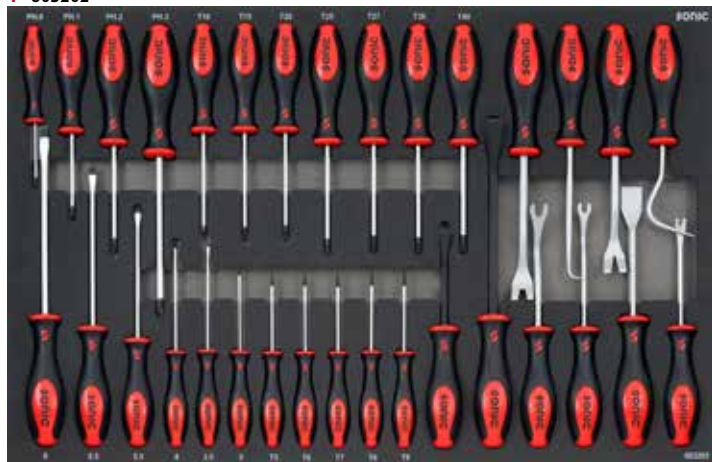

2 315601



3 605301



4 602204



5 604202



6 604001



469-PCS

ART. NO. 746929



7 DRAWERS FILLED WITH 469-PCS TOOLS

FOR DETAILS ABOUT THE SPECIFICATIONS OF THE TOOL BOX, SEE CHAPTER EMPTY STORAGE SYSTEMS

FOR DETAILS ABOUT THE CONTENTS OF THE TOOL BOX, SEE CHAPTER TOOLS SETS

1 MORE INFO WWW.SONIC-EQUIPMENT.COM

1 603202

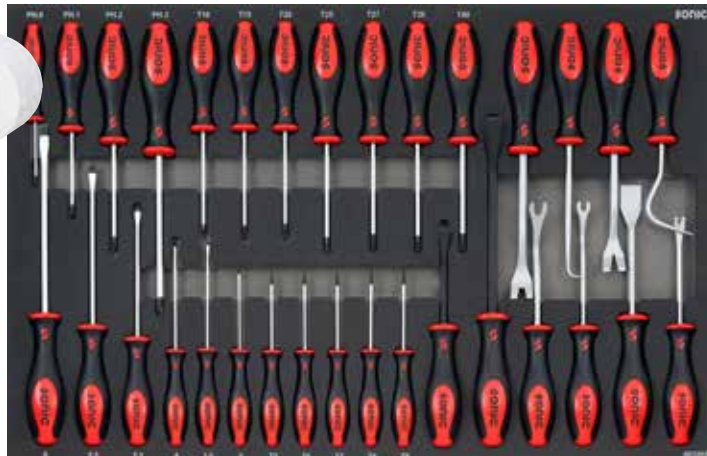

2 221201

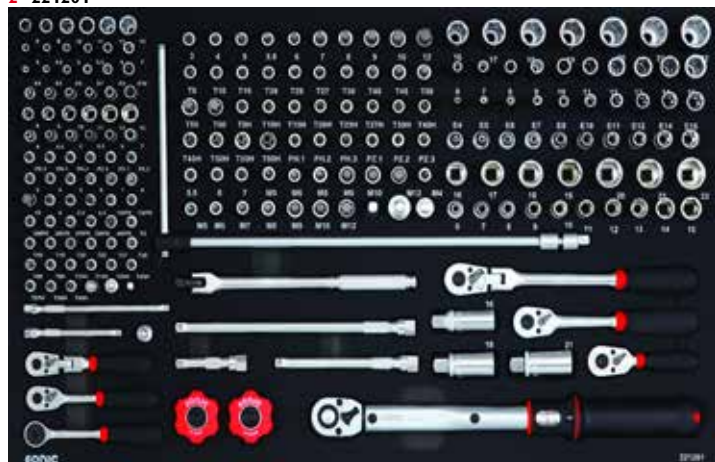

3 308401



4 605301



5 602204



6 604202



7 602411





BLACK FALCON, GERMANY

533-PCS

ART. NO. 753329	S12
ART. NO. 753311	S11
ART. NO. 753317	S11
ART. NO. 753318	S11
ART. NO. 753320	S11



8 DRAWERS FILLED WITH 533-PCS TOOLS

FOR DETAILS ABOUT THE SPECIFICATIONS OF THE TOOL BOX, SEE CHAPTER EMPTY STORAGE SYSTEMS

FOR DETAILS ABOUT THE CONTENTS OF THE TOOL BOX, SEE CHAPTER TOOLS SETS

WWW.SONIC-EQUIPMENT.COM

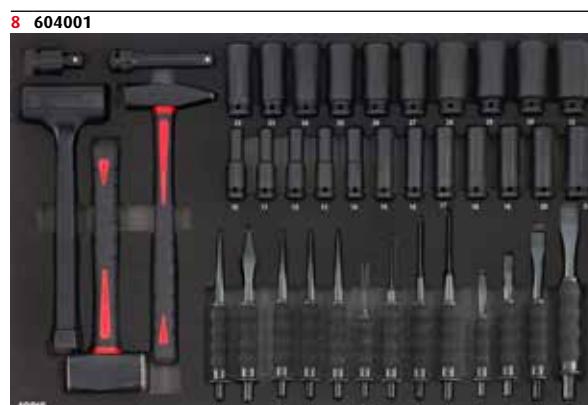
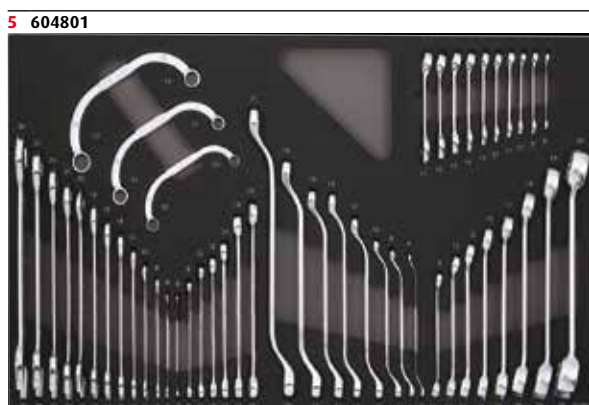
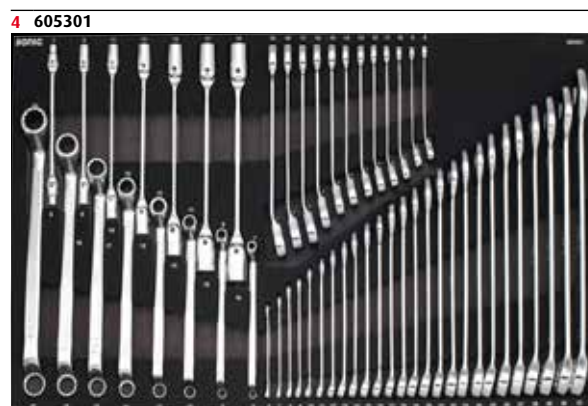
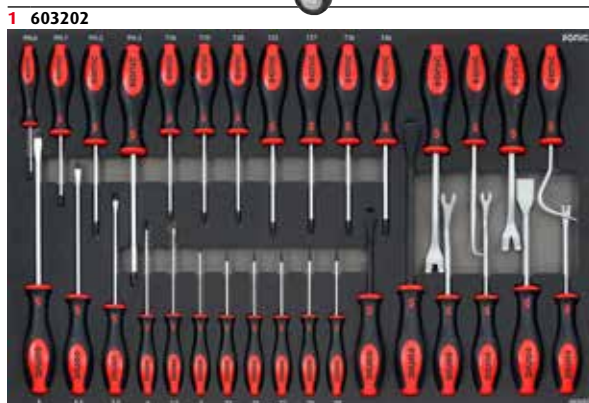

485-PCS

1 603202

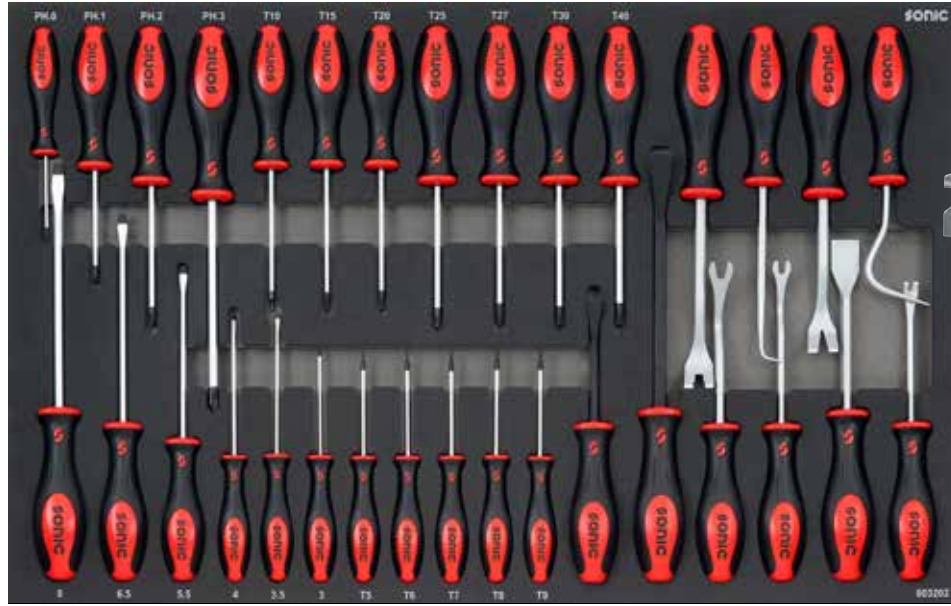

2 221201



3 308401



ART. NO. 748529	S12
ART. NO. 748512	S11
ART. NO. 748517	S11
ART. NO. 748518	S11
ART. NO. 748520	S11



7 DRAWERS FILLED WITH 485-PCS TOOLS

FOR DETAILS ABOUT THE SPECIFICATIONS OF THE TOOL BOX, SEE CHAPTER EMPTY STORAGE SYSTEMS.

FOR DETAILS ABOUT THE CONTENTS OF THE TOOL BOX, SEE CHAPTER TOOLS SETS

i MORE INFO WWW.SONIC-EQUIPMENT.COM

4 605301





5 602204



6 604202



7 604001



575-PCS

1 114602

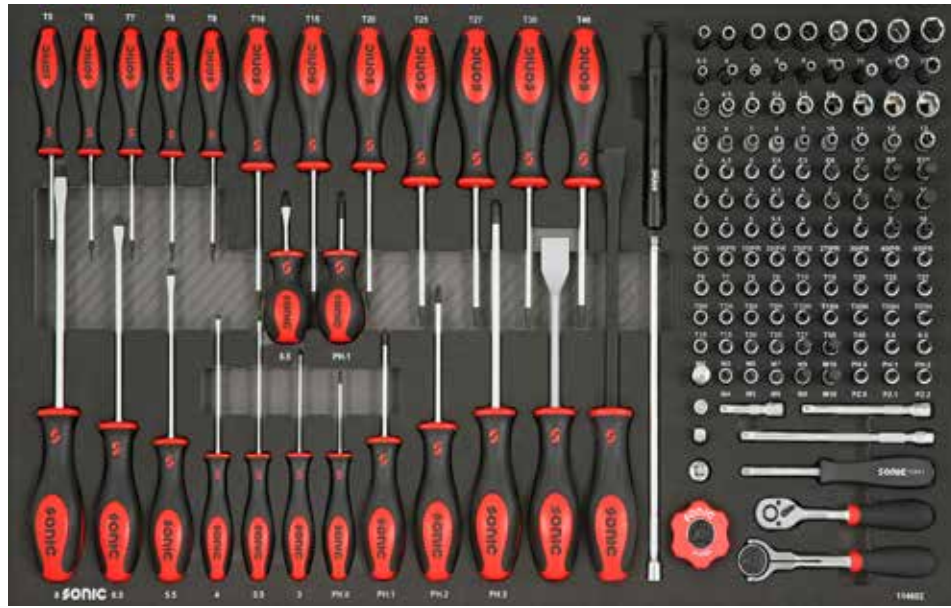

2 216401



ART. NO. 757529	S12
ART. NO. 757511	S11
ART. NO. 757517	S11
ART. NO. 757518	S11
ART. NO. 757520	S11



7 DRAWERS FILLED WITH 575-PCS TOOLS

FOR DETAILS ABOUT THE SPECIFICATIONS OF THE TOOL BOX, SEE CHAPTER EMPTY STORAGE SYSTEMS.

FOR DETAILS ABOUT THE CONTENTS OF THE TOOL BOX, SEE CHAPTER TOOLS SETS

i MORE INFO WWW.SONIC-EQUIPMENT.COM

3 311801



4 605301





5 602605



6 602803



7 604001



03

644-PCS

1 114602

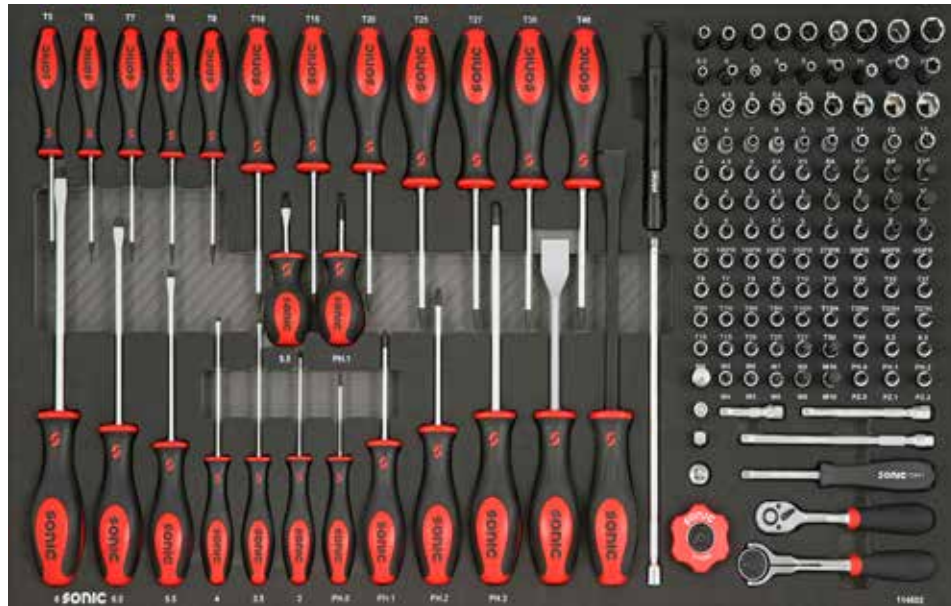

ART. NO. 764429	S12
ART. NO. 764411	S11
ART. NO. 764417	S11
ART. NO. 764418	S11
ART. NO. 764420	S11



8 DRAWERS FILLED WITH 644-PCS TOOLS

FOR DETAILS ABOUT THE SPECIFICATIONS OF THE TOOL BOX, SEE CHAPTER EMPTY STORAGE SYSTEMS
FOR DETAILS ABOUT THE CONTENTS OF THE TOOL BOX, SEE CHAPTER TOOLS SETS
i MORE INFO WWW.SONIC-EQUIPMENT.COM

2 216401



4 605301



3 311801



5 606901



6 602605



7 602803



8 604001



605-PCS

ART. NO. 760546

1

600719	600718
600822	600717
600823	600824

3

301603	302104
302003	302204
305605	300908

5

600614	602205
601227	600705
600319	600825

2

603004	202301
203001	208001
110201	201401

4

601225	601226
600709	601017
601903	601904

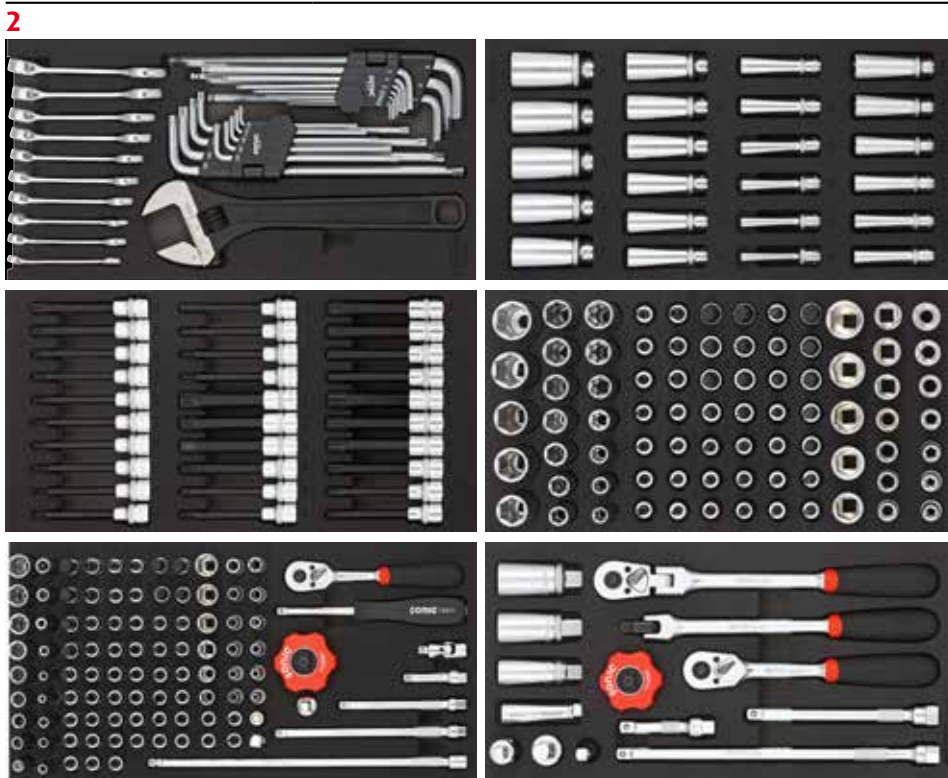
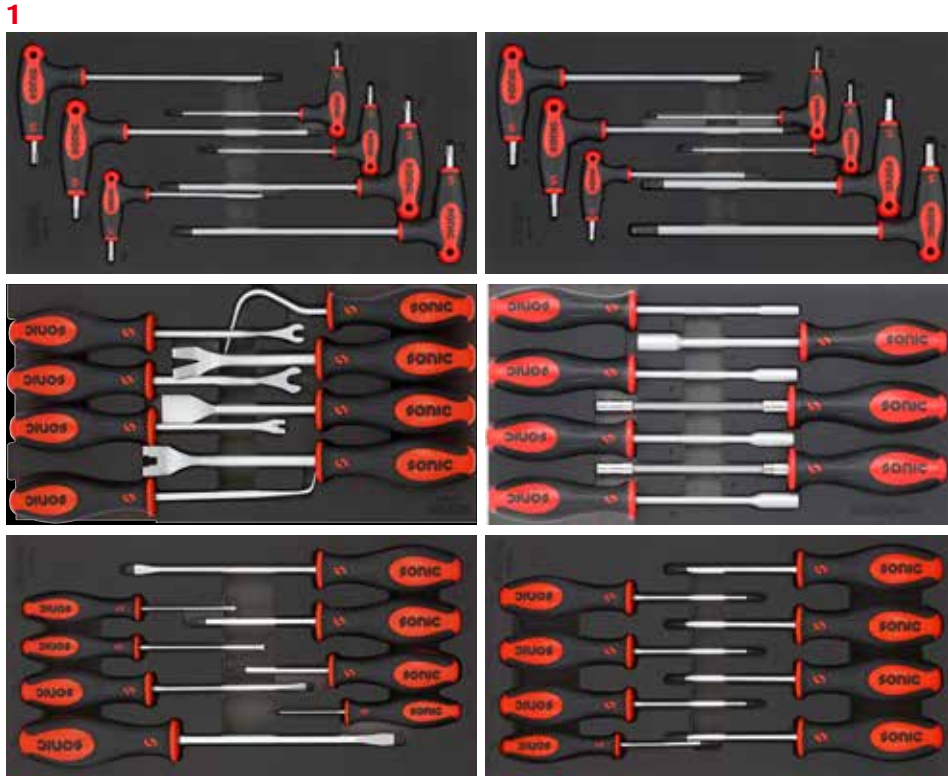

EXTRA

5 DRAWERS FILLED WITH 605-PCS TOOLS

FOR DETAILS ABOUT THE SPECIFICATIONS OF THE TOOL BOX, SEE CHAPTER EMPTY STORAGE SYSTEMS
FOR DETAILS ABOUT THE CONTENTS OF THE TOOL BOX, SEE CHAPTER TOOLS SETS

i MORE INFO WWW.SONIC-EQUIPMENT.COM





DEEP

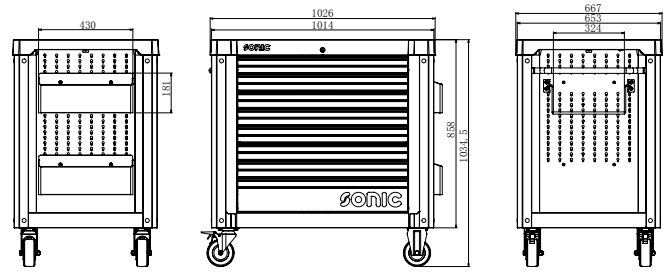

03

5



4

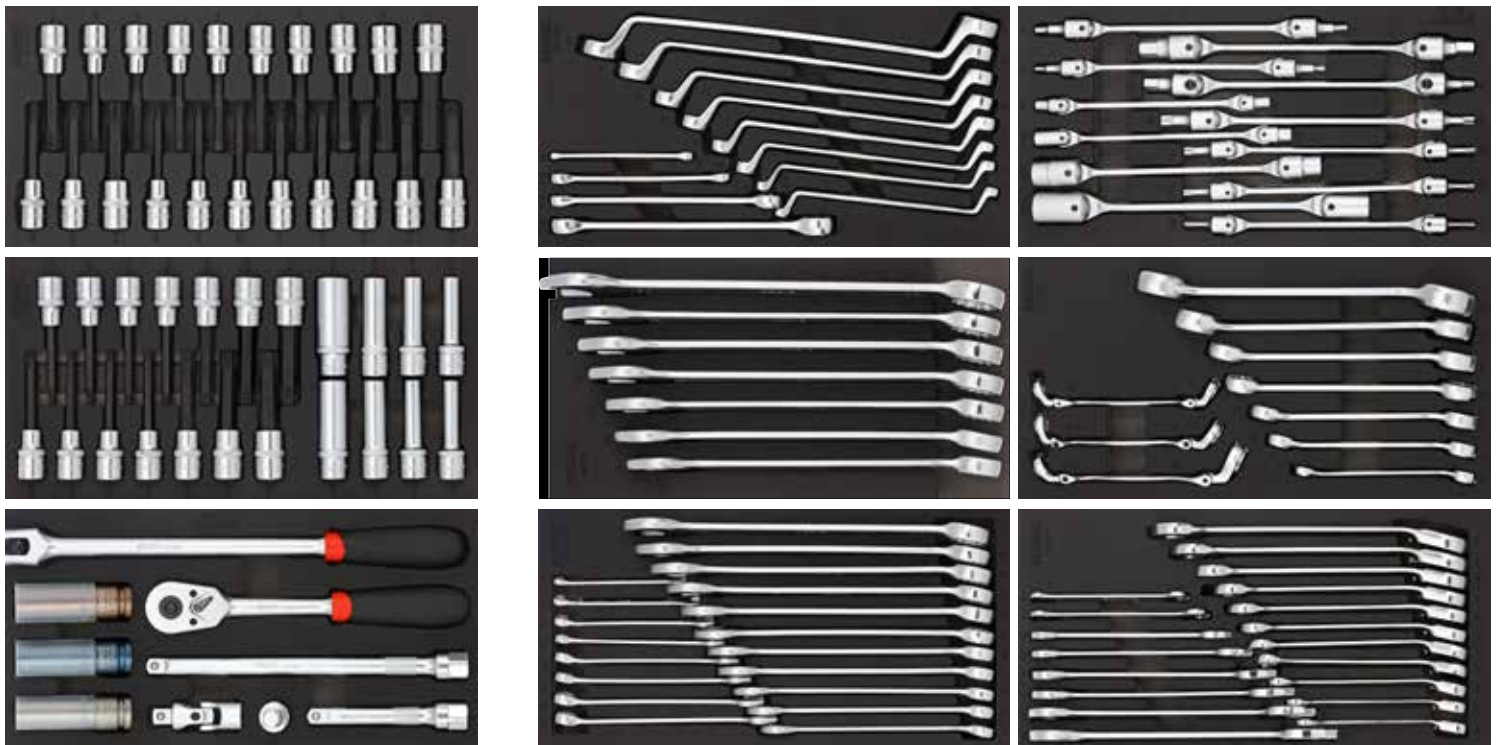

ART. NO. 728907

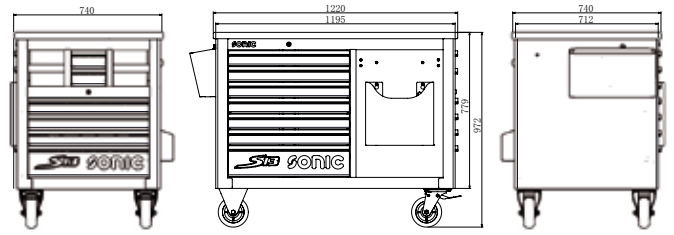

13 DRAWERS
5 DRAWERS FILLED WITH 290-PCS TOOLS

FOR DETAILS ABOUT THE SPECIFICATIONS OF THE TOOL BOX, SEE CHAPTER EMPTY STORAGE SYSTEMS

FOR DETAILS ABOUT THE CONTENTS OF THE TOOL BOX, SEE CHAPTER TOOLS SETS

1 MORE INFO WWW.SONIC-EQUIPMENT.COM

1 112102



2 310101



3 604002

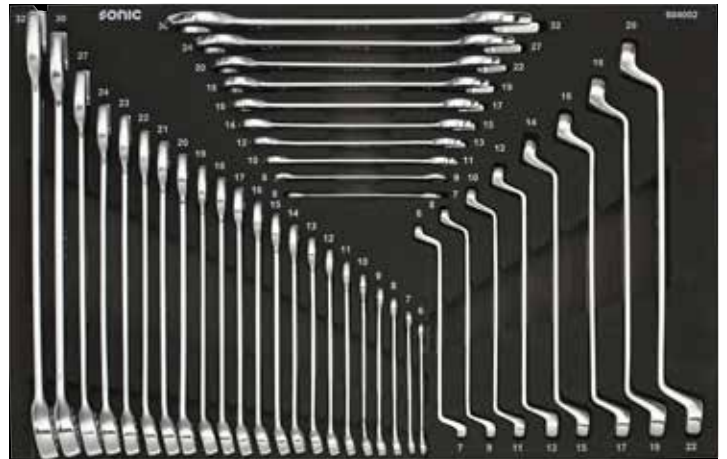

4 601601



5 601207

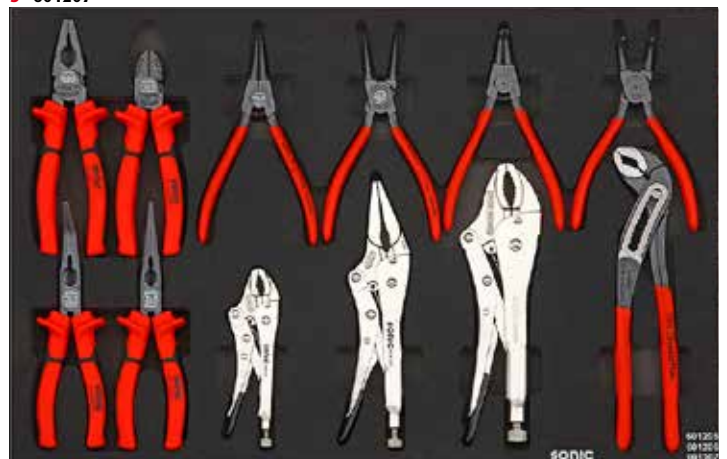

540-PCS

ART. NO. 754007



HEAVY DUTY

13 DRAWERS
11 DRAWERS FILLED
WITH 540-PCS TOOLS

MAIN FEATURES

- 13 DRAWERS;
- 9 SHALLOW DRAWERS
- 2 DEEP DRAWERS
- 2 SMALL QUARTER DRAWERS
- WOODEN TOPBLADE
- DOCUMENT HOLDER
- DRAWER BASE PROTECTED BY FOAM RUBBER MAT
- DRAWER BLOCKING SYSTEM, AS PROTECTION AGAINST TIPPING OVER
- 100% RETRACTABLE DRAWERS
- POWDER COATING EXTERIOR
- FRONT CENTRALIZED SAFETY LOCK
- CAN HOLDER
- PAPER ROLL HOLDER
- GARBAGE BIN
- 4 EXTRA LARGE WHEELS Ø125MM, WHEREOF 2 CASTERS WITH ROLLING AND TURNING BRAKE



1 602407

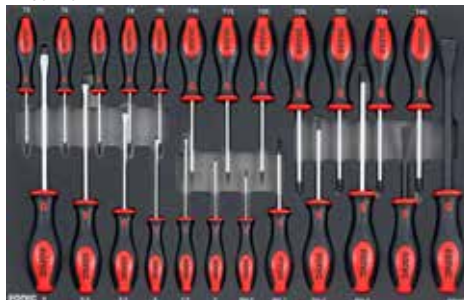

2 215702



3 309502



4 603002



5 604702



6 601207

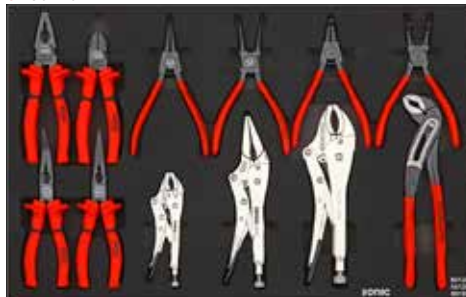

7 601601



8 307302



9 403301



10 403201



11 602104



ART. NO. 760508

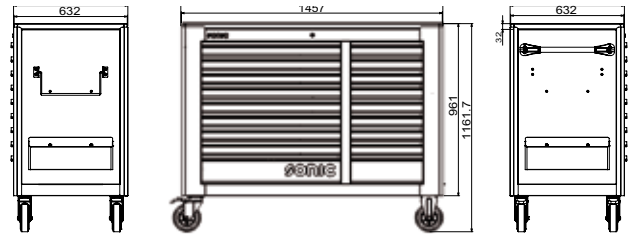

5 DRAWERS FILLED WITH 605-PCS TOOLS

FOR DETAILS ABOUT THE SPECIFICATIONS OF THE TOOL BOX, SEE CHAPTER EMPTY STORAGE SYSTEMS
FOR DETAILS ABOUT THE CONTENTS OF THE TOOL BOX, SEE CHAPTER TOOLS SETS

i MORE INFO WWW.SONIC-EQUIPMENT.COM

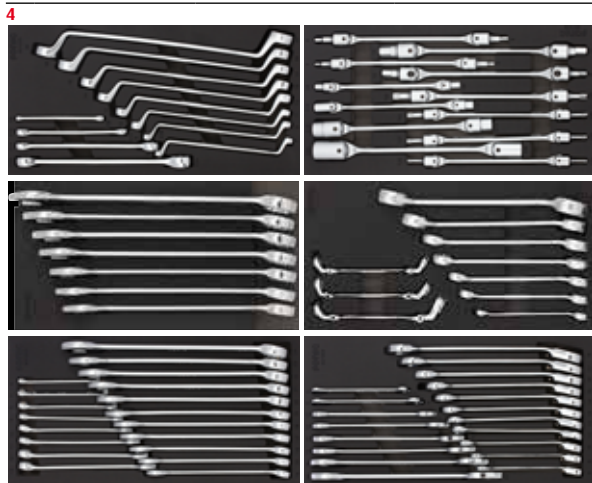
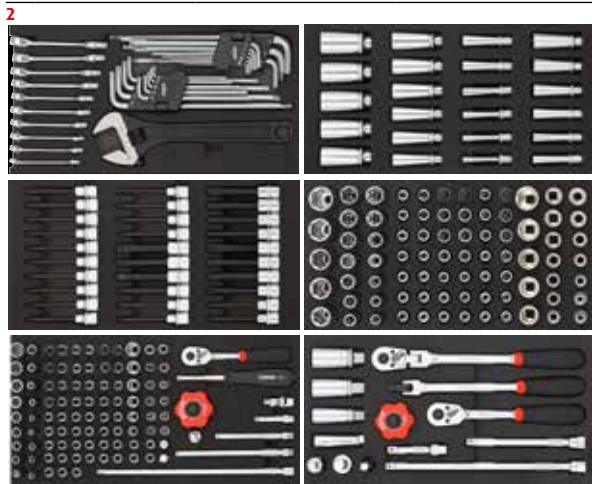
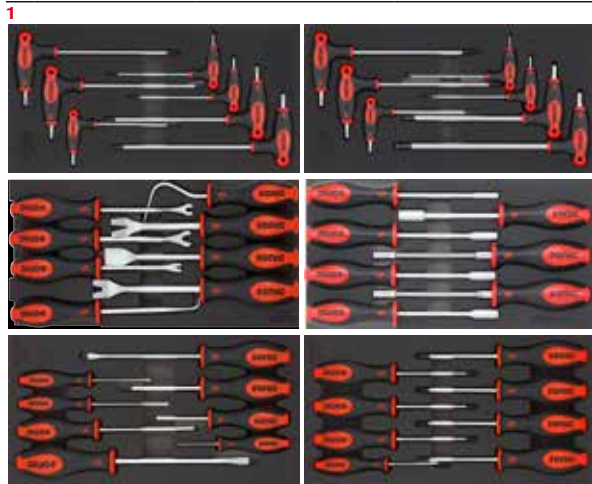

1

600719	600718
600822	600717
600823	600824

2

603004	202301
203001	208001
110201	201401

3

301603	302104
302003	302204
305605	300908

4

601225	601226
600709	601017
601903	601904

5

600614	602205
601227	600705
600319	600825

644-PCS

ART. NO. 764408



8 DRAWERS FILLED WITH 644-PCS TOOLS

MAIN FEATURES

- 18 DRAWERS;
- 16 SHALLOW DRAWERS
- 2 DEEP DRAWERS
- DRAWER BASE PROTECTED BY FOAM RUBBER MAT
- DRAWER BLOCKING SYSTEM, AS PROTECTION AGAINST TIPPING OVER
- DRAWER RELEASE SYSTEM, NO MECHANISM IN THE HANDLE
- 100% RETRACTABLE DRAWERS
- POWDER COATING EXTERIOR
- FRONT CENTRALIZED SAFETY LOCK
- FOLDING KEY
- WOODEN TOP BLADE
- 2 CAN HOLDERS
- PAPER ROLL HOLDER
- AUTO RETURN BALL BEARING SLIDES
- PPU CASTERS (Ø 155MM- 50MM) 2 SWIVEL CASTERS WITH BRAKE AND 2 FIXED CASTERS

1 114602

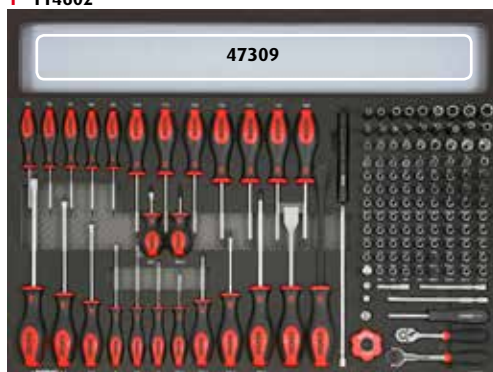

2 216401



3 311801



4 605301



5 606901

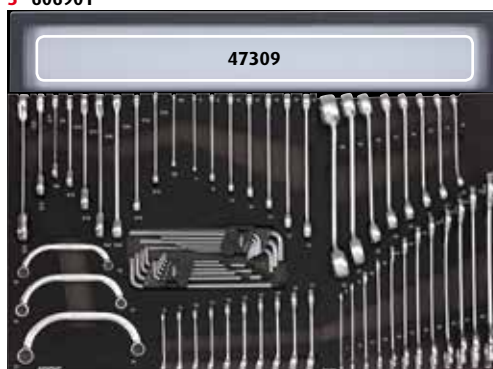

6 602605



7 602803

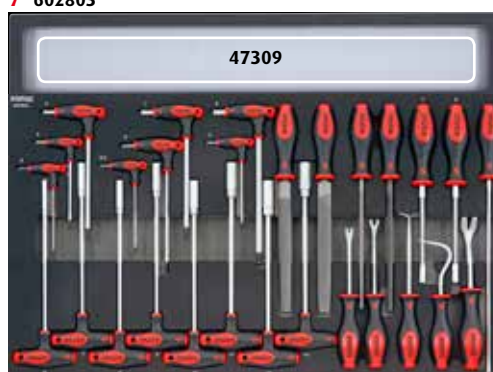

8 604001



ART. NO. 757544

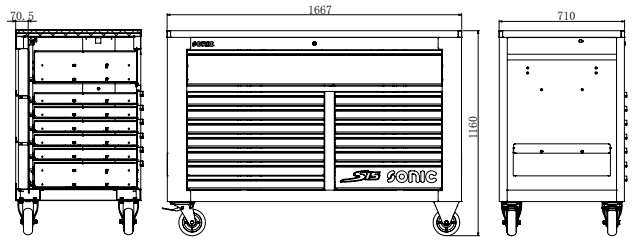

13 DRAWERS 5 DRAWERS FILLED WITH 575-PCS TOOLS

FOR DETAILS ABOUT THE SPECIFICATIONS OF THE TOOL BOX, SEE CHAPTER EMPTY STORAGE SYSTEMS
FOR DETAILS ABOUT THE CONTENTS OF THE TOOL BOX, SEE CHAPTER TOOLS SETS

i MORE INFO WWW.SONIC-EQUIPMENT.COM

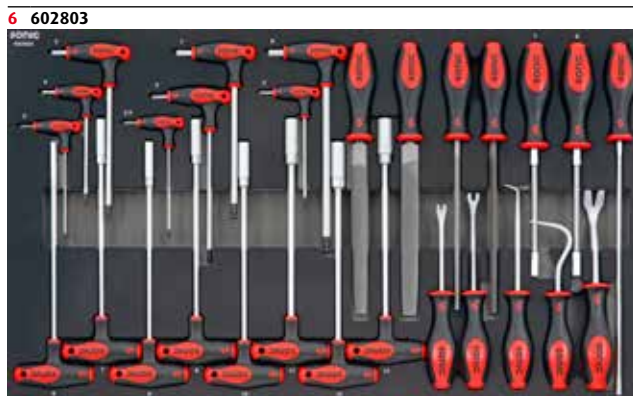
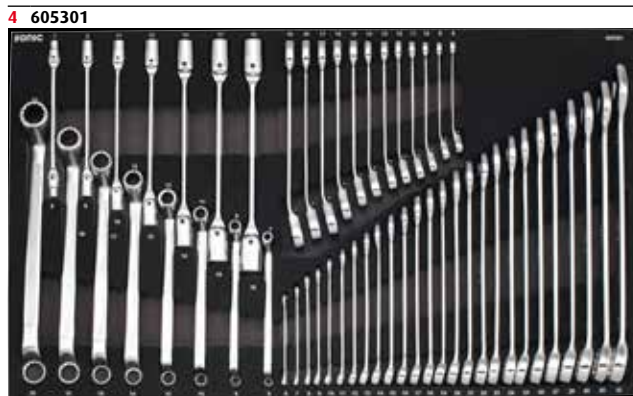
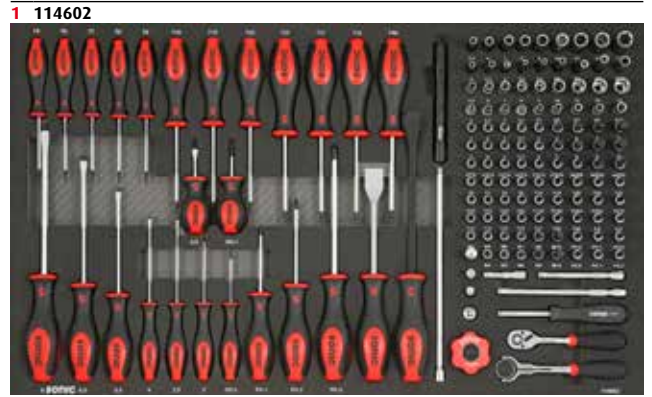

605-PCS

ART. NO. 760544



13 DRAWERS 5 DRAWERS FILLED WITH 345-PCS TOOLS

FOR DETAILS ABOUT THE SPECIFICATIONS OF THE TOOL BOX, SEE CHAPTER EMPTY STORAGE SYSTEMS

FOR DETAILS ABOUT THE CONTENTS OF THE TOOL BOX, SEE CHAPTER TOOLS SETS

i MORE INFO WWW.SONIC-EQUIPMENT.COM

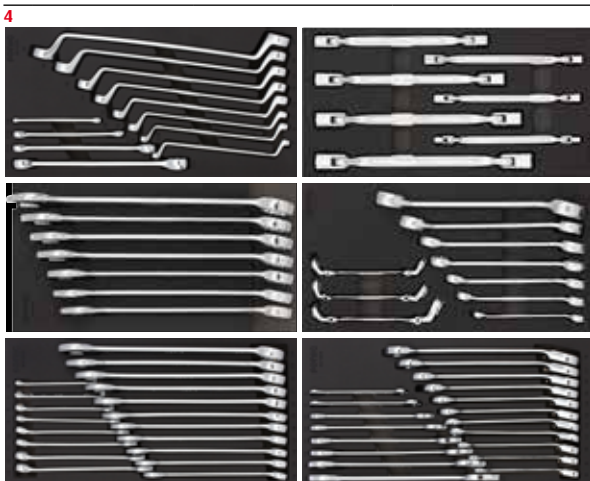
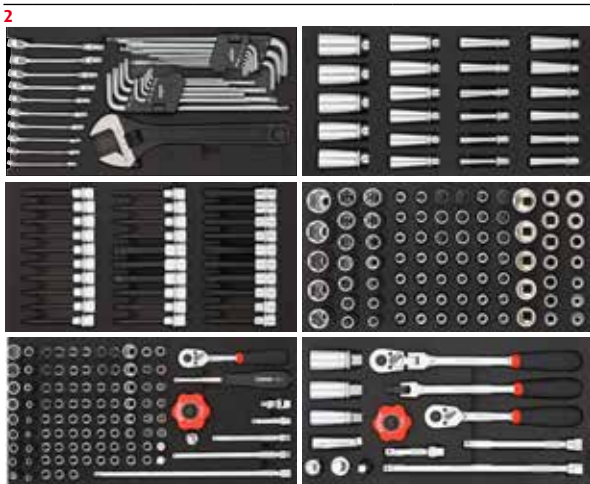
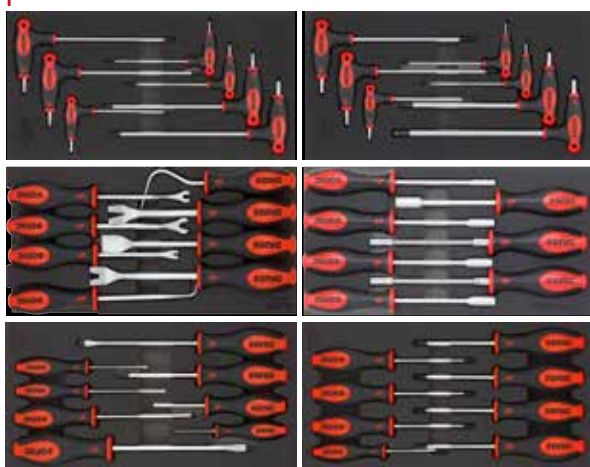

600719	600718
600822	600717
600823	600824

603004	202301
203001	208001
110201	201401

301603	302104
302003	302204
305605	300908

601225	600708
600709	601017
601903	601904

600614	602205
601227	600705
600319	600825



60-PCS

ART. NO. 706001

SCREWDRIVER PH



ART. NO.	CONTENTS
1311	SCREWDRIVER PH.1
1312	SCREWDRIVER PH.2
1313	SCREWDRIVER PH.3

SLOTTED SCREWDRIVER



ART. NO.	CONTENTS
13335	SLOTTED SCREWDRIVER 3.5MM
13355	SLOTTED SCREWDRIVER 5.5MM
13365	SLOTTED SCREWDRIVER 6.5MM

SCREWDRIVER STUBBY, PH



ART. NO.	CONTENTS
13125	SCREWDRIVER STUBBY PH.2

SCREWDRIVER STUBBY, SLOTTED



ART. NO.	CONTENTS
1330655	SLOTTED STUBBY SCREWDRIVER 6.5MM

FLANK SOCKET



ART. NO.	CONTENTS
301007	10-PCS 1/2" 6PT. 11, 12, 13, 14, 15, 17, 19, 21, 22, 24MM

COMBINATION WRENCH



ART. NO.	CONTENTS
41508...17	8-PCS 8, 10, 11, 12, 13, 14, 15, 17MM

COMBINATION PLIERS



ART. NO.	CONTENTS
4311175	COMBINATION PLIERS 7"

FILLED SUITCASE

MAIN FEATURES

- MEASUREMENTS: L 460 X D 160 X H 310MM
- WEIGHT: 4 KG (EMPTY)
- MATERIAL: ABS-HARD SHELL CASE
- EXECUTION: 2 LOCKS, TOOL PANEL WITH INSERT SYSTEM, BOTTOM TRAY WITH ADJUSTABLE COMPARTMENTS, FLEXIBLE HANDLE, STURDLY AGAINST HEAT, COLDNESS AND MECHANICAL LOAD.

DIAGONAL PLIERS



ART. NO.	CONTENTS
4341175	DIAGONAL PLIERS 7"

WATERPUMP PLIERS



ART. NO.	CONTENTS
4351250	WATERPUMP PLIERS 10"

LOCKING PLIERS



ART. NO.	CONTENTS
4380250	LOCKING PLIERS 10"

ADJUSTABLE WRENCH



ART. NO.	CONTENTS
42301250	ADJUSTABLE WRENCH 10"

MACHINIST HAMMER



ART. NO.	CONTENTS
4611400	MACHINIST HAMMER 400GR

UTILITY KNIFE



ART. NO.	CONTENTS
46806	UTILITY KNIFE INCLUDING 10 BLADES

MEASURING TAPE



ART. NO.	CONTENTS
47013	MEASURINGTAPE 5 METER



EMPTY SUITCASE



ART. NO.	CONTENTS
47304	EMPTY SUITCASE

MINI HACKSAW



ART. NO.	CONTENTS
46602	MINI HACKSAW

SAW BLADE



ART. NO.	CONTENTS
46603	SAW BLADE 3-PCS

RATCHET HANDLE



ART. NO.	CONTENTS
7120903	RATCHET HANDLE 1/2" -45 TEETH

HEX KEY



ART. NO.	CONTENTS
600713	7-PCS HEX KEY (FOLDING)

FLANK SOCKET SET



ART. NO.	CONTENTS
104601	46-PCS 1/4" FLANK SOCKET SET

91-PCS

ART. NO. 709101

PHILLIPS PH



ART. NO.	CONTENTS
1311	SCREWDRIVER PH.1
1312	SCREWDRIVER PH.2
1313	SCREWDRIVER PH.3

SLOTTED SCREWDRIVER



ART. NO.	CONTENTS
13303	SLOTTED SCREWDRIVER 3MM
13304	SLOTTED SCREWDRIVER 4MM
13355	SLOTTED SCREWDRIVER 5.5MM
13365	SLOTTED SCREWDRIVER 6.5MM

FLANK SOCKET



ART. NO.	CONTENTS
301201	12-PCS 1/2" SOCKET ON RAIL 8, 9, 10, 11, 12, 13, 14, 15, 16, 17, 18, 19MM

COMBINATION WRENCH



ART. NO.	CONTENTS
600904	9-PCS COMBINATION WRENCH SET IN POUCH 6, 8, 10, 11, 12, 13, 14, 17, 19MM

COMBINATION PLIERS



ART. NO.	CONTENTS
4311175	COMBINATION PLIERS 7"

LONG NOSE PLIERS



ART. NO.	CONTENTS
4321200	LONG NOSE PLIERS 8"

FILLED SUITCASE

MAIN FEATURES:

- MEASUREMENTS: L 360 X D 475 X H 200MM
- WEIGHT: 5KG
- MATERIAL: ABS-HARD SHELL CASE, BLACK
- 2 CYLINDER KEY-LOCKS, 10 TOOL HOLDERS IN THE TRAY COVER AND AN ASSORTMENT OF 3 INSERTS WITHIN THE TRAY ITSELF, DOUBLE-SIDED TOOL PANEL WITH 24+14 TOOL HOLDERS



DIAGONAL PLIERS



ART. NO.	CONTENTS
4341175	DIAGONAL PLIERS 7"

WATERPUMP PLIERS



ART. NO.	CONTENTS
4351250	WATERPUMP PLIERS 10"

LOCKING PLIERS



ART. NO.	CONTENTS
4380250	LOCKING PLIERS 10"

ADJUSTABLE WRENCH



ART. NO.	CONTENTS
42301250	ADJUSTABLE WRENCH 10"

MACHINIST HAMMER



ART. NO.	CONTENTS
4611400	MACHINIST HAMMER 400GR. FIBRE HANDLE TPR COVER

UTILITY KNIFE



ART. NO.	CONTENTS
46806	UTILITY KNIFE INCLUDING 10 BLADES

RATCHET HANDLE



ART. NO.	CONTENTS
7120903	1/2" RATCHET HANDLE 45 TEETH

EMPTY SUITCASE



ART. NO.	CONTENTS
47504	EMPTY SUITCASE L (MADE IN EU)

MEASURING TAPE



ART. NO.	CONTENTS
47013	MEASURING TAPE 5 METER

HEX KEY



ART. NO.	CONTENTS
600713	7-PCS HEX KEY SET (FOLDING)

FLANK SOCKET SET



ART. NO.	CONTENTS
104601	46-PCS 1/4" 6PT. FLANK SOCKET SET

132-PCS

ART. NO. 713201
ART. NO. 47502
SUITCASE EMPTY XL (MADE IN EU)



FILLED SUITCASE

MAIN FEATURES

- MEASUREMENTS: L 410 X D 485 X H 215MM
- WEIGHT: 6KG
- MATERIAL: ABS-HARD SHELL CASE, BLACK
- 2 CYLINDER KEY-LOCKS, 11 TOOL HOLDERS IN THE TRAY COVER AND 2 INSERTS WITHIN THE TRAY ITSELF, DOUBLE-SIDED TOOL PANEL WITH 28+17 TOOL HOLDERS, SINGLE SIDED PANEL WITH 23 TOOL HOLDERS PLUS A DOCUMENT HOLDER



SCREWDRIVER PH



ART. NO.	CONTENTS
1311	SCREWDRIVER PH.1
1312	SCREWDRIVER PH.2
1313	SCREWDRIVER PH.3

SLOTTED SCREWDRIVER



ART. NO.	CONTENTS
13303	SLOTTED SCREWDRIVER 3MM
13304	SLOTTED SCREWDRIVER 4MM
13355	SLOTTED SCREWDRIVER 5.5MM
13365	SLOTTED SCREWDRIVER 6.5MM

SCREWDRIVER TX



ART. NO.	CONTENTS
13610	SCREWDRIVER T10
13615	SCREWDRIVER T15
13620	SCREWDRIVER T20
13625	SCREWDRIVER T25
13627	SCREWDRIVER T27
13630	SCREWDRIVER T30

COMBINATION WRENCH



ART. NO.	CONTENTS
601401	14-PCS COMBINATION WRENCH SET IN POUCH 6, 7, 8, 9, 10, 11, 12, 13, 14, 15, 16, 17, 19, 22MM

COMBINATION PLIERS



ART. NO.	CONTENTS
4311175	COMBINATION PLIERS 7"

LONG NOSE PLIERS



ART. NO.	CONTENTS
4321200	LONG NOSE PLIERS 8"

132-PCS

ART. NO. 713202
ART. NO. 47503
SUITCASE TROLLEY EMPTY XL (MADE IN EU)



FILLED SUITCASE TROLLEY

MAIN FEATURES

- MEASUREMENTS: L 410 X D 485 X H 215MM
- WEIGHT: 6,5KG
- MATERIAL: ABS-HARD SHELL CASE, BLACK
- 2 CYLINDER KEY-LOCKS, 11 TOOL HOLDERS IN THE TRAY COVER AND AN ASSORTMENT OF 5 INSERTS WITHIN THE TRAY ITSELF, DOUBLE-SIDED TOOL PANEL WITH 28+17 TOOL HOLDERS, SINGLE SIDED PANEL WITH 23 TOOL HOLDERS PLUS A DOCUMENT HOLDER



DIAGONAL PLIERS



ART. NO.	CONTENTS
4341175	DIAGONAL PLIERS 7"

WATERPUMP PLIERS



ART. NO.	CONTENTS
4351180	WATERPUMP PLIERS 7"
4351250	WATERPUMP PLIERS 10"

ADJUSTABLE WRENCH



ART. NO.	CONTENTS
42302150	ADJUSTABLE WRENCH 6"
42301250	ADJUSTABLE WRENCH 10"

WIRE STRIPPER



ART. NO.	CONTENTS
4471250	WIRE STRIPPER 10"

GRIP CHISEL



ART. NO.	CONTENTS
45112160	GRIP CHISEL 160MML 12
45118190	GRIP CHISEL 190MML 18

GRIP TAPER PUNCH



ART. NO.	CONTENTS
4553185	GRIP TAPER PUNCH 185MML 3

MACHINIST HAMMER



ART. NO.	CONTENTS
4611400	MACHINIST HAMMER 400GR. FIBRE HANDLE TPR COVER

UTILITY KNIFE



ART. NO.	CONTENTS
46806	UTILITY KNIFE INCLUDING 10 BLADES

MEASURING TAPE



ART. NO.	CONTENTS
47013	MEASURING TAPE 5 METER

MAGNET FLEXIBLE



ART. NO.	CONTENTS
4820110	MAGNET FLEXIBLE

FLASH PEN



ART. NO.	CONTENTS
4821105	FLASH PEN

HEX KEY



ART. NO.	CONTENTS
601008	10-PCS HEX BALL EXTRA LONG KEY SET

STAR KEY



ART. NO.	CONTENTS
600902	9-PCS STAR EXTRA LONG KEY SET T10, T15, T20, T25, T27, T30, T40

FLANK SOCKET SET



ART. NO.	CONTENTS
104601	46-PCS 1/4" 6PT. FLANK SOCKET SET

SOCKET SET



ART. NO.	CONTENTS
302403	24-PCS 1/2" SOCKET SET MBS

**SPECIALLY DESIGNED
FOR CART SPORT**



**TOPBOX FILLED
WITH 47-PCS TOOLS**

FOR DETAILS ABOUT THE SPECIFICATIONS
OF THE TOOLBOX, SEE CHAPTER EMPTY
STORAGE SYSTEMS

FOR DETAILS ABOUT THE CONTENTS OF
THE TOOLBOX, SEE CHAPTER TOOLS SETS

**TOPBOX FILLED
WITH 96-PCS TOOLS**

FOR DETAILS ABOUT THE SPECIFICATIONS
OF THE TOOLBOX, SEE CHAPTER EMPTY
STORAGE SYSTEMS

FOR DETAILS ABOUT THE CONTENTS OF
THE TOOLBOX, SEE CHAPTER TOOLS SETS

47-PCS

96-PCS

ART. NO. 704721

ART. NO. 709601

1 102502



1 602402



1 601018



1 600929

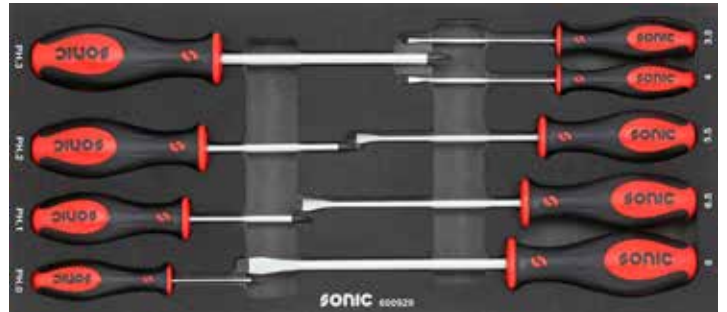

1 601112



1 305101



1 47030



1 601203



62-PCS

ART. NO. 706201

5 TRAYS FILLED TOOLBOX

MAIN FEATURES

- UNFOLDABLE TO A WIDTH OF 53CM
- NO DIVIDER IN UPPER TRAY
- SHEET THICKNESS COVER 0,6MM, SHEET THICKNESS BOX 0,55MM
- PIANO HINGED COVER
- POWDER COATED TRAFFIC BLACK RAL 9017
- PRINT 'SONIC' IN BOTH LOWER TRAYS IN THE LEFT CORNER OF THE LONG SIDES
- INDIVIDUALLY PACKED IN A CARTON
- WEIGHT: 16,7KG
- MEASUREMENTS: L 565 X D 200 X H 200MM



206-PCS

ART. NO. 720628
FILLED S9 TOPBOX 206-PCS
ART. NO. 720634
FILLED S9 TOPBOX TROLLEY 206-PCS



285-PCS

ART. NO. 728528
FILLED S9 TOPBOX 285-PCS
ART. NO. 728534
FILLED S9 TOPBOX TROLLEY 285-PCS

3 AND 4 DRAWERS FILLED TOPBOXES

MAIN FEATURES

- 4 DRAWERS WITH BALL BEARING SLIDES
- FRONT CENTRALIZED SAFETY LOCK
- 100% RETRACTABLE DRAWERS
- POWDER COATING EXTERIOR
- HEIGHT DRAWERS 60MM
- WEIGHT 39KG



1 602904



2 316001



3 601707



1 112102



2 310101



3 604002

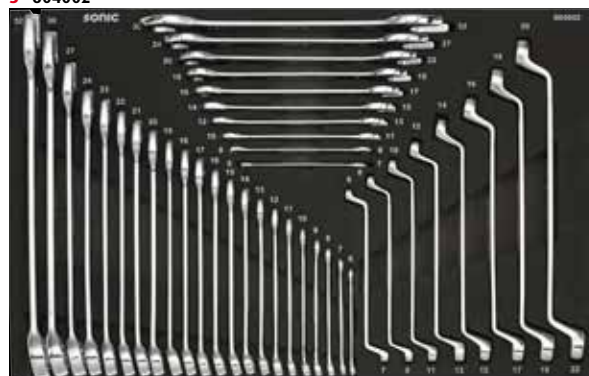

4 602302







BUILD YOUR OWN UNIQUE TOOL BOX

SONIC FOAM SYSTEM

IN THE SONIC FOAM SYSTEM(SFS) THE TOOLS ARE STORED IN A WELL ORGANIZED, CHEMICAL RESISTANT, LASER ENGRAVED FOAM INLAY.

- BETTER-ORGANISED, QUICKLY ACCESSIBLE FOR FAST WORKABILITY
- ERGONOMIC LAY-OUT
- TWO TONE COLOR SYSTEM FOR CONVENIENT SURVEY OF MISSING TOOLS
- DURING STORAGE THE TOOLS DO NOT DAMAGE
- SIZES OF TOOLS ARE MENTIONED ON THE FOAM
- SUITABLE FOR 26" AND 34" STORAGE SYSTEMS.

FOAM SYSTEM DRAWER FOR TOPBOX S7, S8, S9, S10, S10 GLASS, S13, S14, S15, MSS

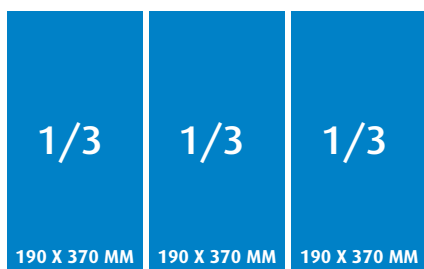

FOAM SYSTEM DRAWER FOR TOPBOX S7, S8, S9, S10, S10 GLASS, S13, S14, S15, MSS

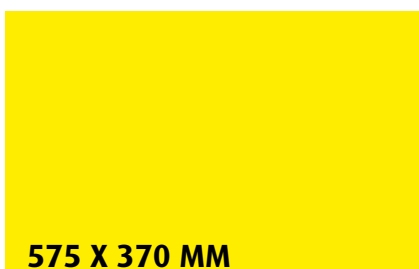

FOAM SYSTEM DRAWER FOR S11, S12, S14, S15, MSS

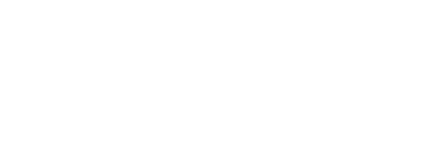
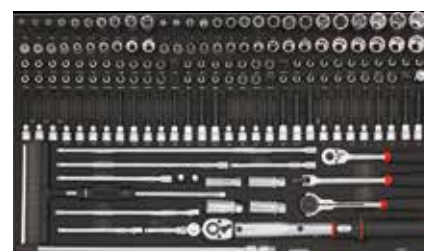



**WORKING
WILL BE
DIFFERENT**



600823



SCREWDRIVER SET SFS 1/3, 8-PCS

ART. NO.	CONTENTS
1310...2	3 SCREWDRIVER PH.0, PH.1, PH.2
13303...08	5 SCREWDRIVER SLOTTED 3, 4, 5.5, 6.5, 8MM

600824



SCREWDRIVER, TX SET SFS 1/3, 8-PCS

ART. NO.	CONTENTS
13608...40	8 SCREWDRIVER, TX T8, T10, T15, T20, T25, T27, T30, T40

600513



GO-THROUGH SCREWDRIVER SET SFS 1/3, 5-PCS

ART. NO.	CONTENTS
15101...02	2 HAMMER GO-THROUGH SCREWDRIVER, PH.1, PH.2
1530155...08	3 HAMMER GO-THROUGH SCREWDRIVER, SLOTTED 5.5, 6.5, 8MM

600826



VDE SCREWDRIVERS SET SFS 1/3, 8-PCS

ART. NO.	CONTENTS
1610...2	3 VDE SCREWDRIVER, PH.0, PH.1, PH.2
16325...65	4 VDE SCREWDRIVER, SLOTTED 2.5, 4, 5.5, 6.5MM
47016	1 ELECTRIC MAIN TESTER 120-250V (GS)

600717



SOCKET SCREWDRIVER, HEX SET SFS 1/3, 7-PCS

ART. NO.	CONTENTS
12425006...11	5 HEX NUT DRIVER 6, 8, 9, 10, 11MM
47537...38	2 FLEXIBLE HEX NUT DRIVER 7, 8MM

600718



HEX BALL GRIP KEY SET SFS 1/3, 7-PCS

ART. NO.	CONTENTS
19502025...08	7 HEX BALL POINT GRIP KEY 2.5, 3, 4, 5, 6, 7, 8MM

600913



HEXAGON KEY WRENCH SET, 3 TIP T-HANDLE SFS 1/3, 9-PCS

ART. NO.	CONTENTS
4840102...08	9 3 TIP HEX KEY T-HANDLE 2, 2.5, 3, 4, 4.5, 5, 6, 7, 8MM

600719

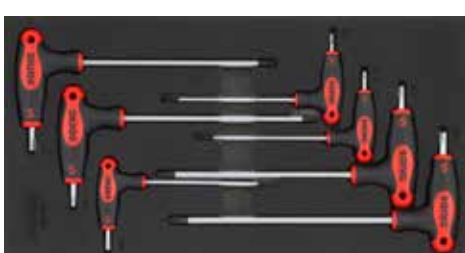

T-HANDLE TX KEY WRENCH SET SFS 1/3, 7-PCS

ART. NO.	CONTENTS
1960210...40	7 T-HANDLE TX KEY WRENCH T10, T15, T20, T25, T27, T30, T40

600914

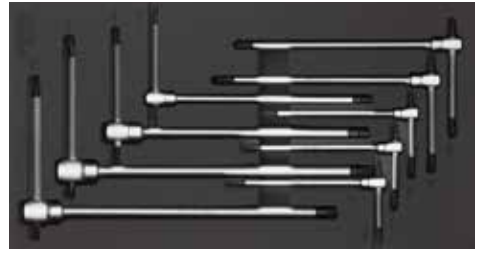

TX KEY SET, 3 TIP T-HANDLE SFS 1/3, 9-PCS

ART. NO.	CONTENTS
4840210...50	9 3 TIP STAR KEY T-HANDLE T10, T15, T20, T25, T27, T30, T40, T45, T50

106303



FLANK SOCKET SET 1/4", 6 PT. SFS 1/3 61-PCS

ART. NO.	CONTENTS
21505...13	10 FLANK SOCKET 1/4", 6 PT. 5, 5.5, 6, 7, 8, 9, 10, 11, 12, 13MM
21604...10	6 SOCKET 1/4", TX E4, E5, E6, E7, E8, E10
601006	10 HEX BALL LONG KEY SET 10-PCS
7120901	1 RATCHET HANDLE 1/4" 45 TEETH
7110301	1 DISC RATCHET 1/4" 72 TEETH
72401	1 SPINNER 1/4" 150MML
7141050...150	3 EXTENSION 1/4" 50, 100, 150MML
71511	1 UNIVERSAL JOINT 1/4"
8113701...02	2 BIT SOCKET PH 1/4", PH.1, PH.2
8143703...08	6 BIT SOCKET HEX 1/4", 3, 4, 5, 6, 7, 8MM
8163706...40	11 BIT SOCKET TX 1/4", T6, T7, T8, T9, T10, T15, T20, T25, T27, T30, T40
8173706...40	11 BIT SOCKET TX TAMPERPROOF 1/4", T6H, T7H, T8H, T9H, T10H, T15H, T20H, T25H, T27H, T30H, T40H

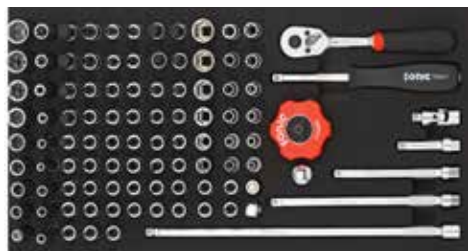
110201

BIT SOCKET SET 1/4", SFS 1/3 102-PCS

ART. NO.	CONTENTS
21504...13	12 FLANK SOCKET 1/4", 6 PT. 4, 4.5, 5, 5.5, 6, 7, 8, 9, 10, 11, 12, 13MM
2155004...13	12 FLANK DEEP SOCKET 1/4", 6 PT. 4, 4.5, 5, 5.5, 6, 7, 8, 9, 10, 11, 12, 13MM
21604...10	6 SOCKET 1/4", TX E4, E5, E6, E7, E8, E10
2165004...10	6 SOCKET 1/4", TX DEEP E4, E5, E6, E7, E8, E10
7120901	1 RATCHET HANDLE 1/4" 45 TEETH
7110301	1 DISC RATCHET 1/4" 72 TEETH
72401	1 SPINNER 1/4" 150MML
7141050...150	3 EXTENSION 1/4" 50, 100, 150MML
7261250	1 WOBBLE EXTENSION 1/4" 250MML
71511	1 UNIVERSAL JOINT 1/4"
71921	1 ADAPTOR 3/8"(F) X 1/4"(M)
71912	1 ADAPTOR 1/4"(F) X 3/8"(M)
72225	1 MAGNET SOCKET PICK-UP 1/4"
8113700...02	3 BIT SOCKET PH 1/4", PH.0, PH.1, PH.2
8123700...02	3 BIT SOCKET PZ 1/4", PZ.0, PZ.1, PZ.2
81337055...65	2 BIT SOCKET SLOTTED 1/4", 5.5, 6.5MM
8143703...10	9 BIT SOCKET HEX 1/4", 3, 4, 5, 5.5, 6, 7, 8, 9, 10MM
8153708...45	9 TAMPER-RESISTANT 1/4", TX PLUS (5 LOBES) 8IPR, 10IPR, 15IPR, 20IPR, 25IPR, 27IPR, 30IPR, 40IPR, 45IPR
8163708...40	9 BIT SOCKET TX 1/4", T8, T9, T10, T15, T20, T25, T27, T30, T40
8173708...40	9 BIT SOCKET TX TAMPERPROOF 1/4", T8H, T9H, T10H, T15H, T20H, T25H, T27H, T30H, T40H
8183704...10	5 BIT SOCKET SPLINE 1/4", M4, M5, M6, M8, M10
8193704...10	6 BIT SOCKET RIBE 1/4", M4, M5, M6, M7, M8, M10

201401

COMBINATION SET 3/8", SFS 1/3 14-PCS

ART. NO.	CONTENTS
7120902	1 RATCHET HANDLE 3/8" 45 TEETH
7110102	1 FLEXIBLE RATCHET 3/8", 45 TEETH
7110302	1 DISC RATCHET 3/8", 72 TEETH
7272250	1 SWIVEL GRIP HANDLE 3/8" 250MML
7142044...250	4 EXTENSION 3/8" 44, 75, 150, 200MML
71521	1 UNIVERSAL JOINT 3/8"
71632	1 ADAPTOR FOR EXTENSION 1/2"(F) X 3/8"(M)
7172214	1 SPARK PLUG CLIP SOCKET 12-PT. 3/8" 14MM
7172216...21	3 SPARK PLUG 3/8" CLIP SOCKET 16, 18, 21MM

204101

BIT SOCKET SET 3/8", SFS 1/3 41-PCS

ART. NO.	CONTENTS
22508...19	12 FLANK SOCKET 3/8", 6 PT. 8, 9, 10, 11, 12, 13, 14, 15, 16, 17, 18, 19MM
22607...14	6 SOCKET 3/8", TX E7, E8, E10, E11, E12, E14
7120902	1 RATCHET HANDLE 3/8" 45 TEETH
7110302	1 DISC RATCHET 3/8", 72 TEETH
7172214	1 SPARK PLUG CLIP SOCKET 12-PT. 3/8" 14MM
7171216...21	3 SPARK PLUG SOCKET 3/8" 16, 18, 21
7142044...200	4 EXTENSION 3/8" 44, 75, 150, 200MML
71521	1 UNIVERSAL JOINT 3/8"
8244806...12	6 BIT SOCKET HEX 3/8", 6, 7, 8, 9, 10, 12MM
8264825...50	6 BIT SOCKET TX 3/8", T25, T27, T30, T40, T45, T50

202301

DEEP SOCKET SET 3/8", SFS 1/3 23-PCS

ART. NO.	CONTENTS
2256310...22	13 FLANK SOCKET 3/8", 6 PT. DEEP 10, 11, 12, 13, 14, 15, 16, 17, 18, 19, 20, 21, 22MM
2266306...20	10 SOCKET 3/8", TX DEEP E6, E7, E8, E10, E11, E12, E14, E16, E18, E20

208001

BIT SOCKET SET 3/8", SFS 1/3 80-PCS

ART. NO.	CONTENTS
22510...22	12 FLANK SOCKET 3/8", 6 PT. 10, 11, 12, 13, 14, 15, 16, 17, 18, 19, 21, 22MM
2256310...22	12 FLANK SOCKET 3/8", 6 PT. DEEP 10, 11, 12, 13, 14, 15, 16, 17, 18, 19, 21, 22MM
22610...20	7 SOCKET 3/8", TX E10, E11, E12, E14, E16, E18, E20
2266310...20	7 SOCKET 3/8", TX DEEP E10, E11, E12, E14, E16, E18, E20
8214801...03	3 BIT SOCKET PH 3/8", PH.1, PH.2, PH.3
8224801...03	3 BIT SOCKET PZ 3/8", PZ.1, PZ.2, PZ.3
8234806	1 BIT SOCKET SLOTTED 3/8", 6MM
8244805...12	7 BIT SOCKET HEX 3/8", 5, 6, 7, 8, 9, 10, 12MM
8264820...50	7 BIT SOCKET TX 3/8", T20, T25, T27, T30, T40, T45, T50
8274820...50	7 BIT SOCKET TX TAMPERPROOF 3/8", T20H, T25H, T27H, T30H, T40H, T45H, T50H
8284804...12	7 BIT SOCKET SPLINE 3/8", M4, M5, M6, M8, M9, M10, M12
8294805...12	7 BIT SOCKET RIBE 3/8", M5, M6, M7, M8, M9, M10, M12

203001

BIT SOCKET SET 3/8", SFS 1/3 30-PCS

ART. NO.	CONTENTS
8249003...10	8 BIT SOCKET HEX 3/8", 90MML 3, 4, 5, 6, 7, 8, 9, 10MM
8269008...50	10 BIT SOCKET TX 3/8", 90MML T8, T10, T15, T20, T25, T27, T30, T40, T45, T50
8289005...12	6 BIT SOCKET SPLINE 3/8", 90MML M5, M6, M8, M9, M10, M12
8299005...12	6 BIT SOCKET RIBE 3/8", 90MML M5, M6, M8, M9, M10, M12

300908

ACCESSORY SET 1/2", SFS 1/3 9-PCS

ART. NO.	CONTENTS
7120903	1 RATCHET HANDLE 1/2" 45 TEETH
7273380	1 SWIVEL GRIP HANDLE 1/2" 380MML
7143125...250	2 EXTENSION 1/2" 125, 250MML
71531	1 UNIVERSAL JOINT 1/2"
71623	1 ADAPTOR FOR EXTENSION 3/8"(F) X 1/2"(M)
3310117...21	3 WHEEL SOCKET 1/2", 6PT. 17, 19, 21MM

302003

DEEP SOCKET SET 1/2", SFS 1/3 20-PCS

ART. NO.	CONTENTS
2357710...32	20 FLANK SOCKET 1/2", 6 PT. DEEP 10, 11, 12, 13, 14, 15, 16, 17, 18, 19, 20, 21, 22, 23, 24, 26, 27, 28, 30, 32MM

301603

IMPACT DEEP SOCKET SET 1/2", SFS 1/3 16-PCS

ART. NO.	CONTENTS
3358513...32	13 IMPACT SOCKET 1/2", 6PT. DEEP 13, 14, 15, 16, 17, 18, 19, 21, 22, 24, 27, 30, 32MM
3398530...36	2 IMPACT SOCKET 1/2", 12PT. DEEP 30, 36MM
7343125	1 IMPACT EXTENSION 1/2" 125MML

303805

BIT SOCKET SET 1/2", SFS 1/3 38-PCS

ART. NO.	CONTENTS
23510...32	20 FLANK SOCKET 1/2", 6 PT. 10, 11, 12, 13, 14, 15, 16, 17, 18, 19, 20, 21, 22, 23, 24, 26, 27, 28, 30, 32MM
23610...24	8 SOCKET 1/2", TX E10, E11, E12, E14, E16, E18, E20, E24
83406208...17	5 BIT SOCKET HEX 1/2", 8, 10, 12, 14, 17MM
83606245...70	5 BIT SOCKET TX 1/2", T45, T50, T55, T60, T70

305605

BIT SOCKET SET 1/2", SFS 1/3 56-PCS

ART. NO.	CONTENTS
23510...32	20 FLANK SOCKET 1/2", 6 PT. 10, 11, 12, 13, 14, 15, 16, 17, 18, 19, 20, 21, 22, 23, 24, 26, 27, 28, 30, 32MM
23614...24	6 SOCKET 1/2", TX E14, E16, E18, E20, E22, E24
83406208...17	6 BIT SOCKET HEX 1/2", 8, 9, 10, 12, 14, 17MM
83606240...70	6 BIT SOCKET TX 1/2", T40, T45, T50, T55, T60, T70
83706240...70	6 BIT SOCKET TAMPERPROOF 1/2", TX T40H, T45H, T50H, T55H, T60H, T70H
83806209...16	5 BIT SOCKET SPLINE 1/2", M9, M10, M12, M14, M16
83806216T	1 BIT SOCKET SPLINE 1/2", M16-T
83906210...14	6 BIT SOCKET RIBE 1/2", M10, M11, M12, M13, M14

302204

SOCKET & SOCKETBIT SET 1/2", SFS 1/3 22-PCS

ART. NO.	CONTENTS
2367710...24	8 SOCKET 1/2" TX DEEP E10, E11, E12, E14, E16, E18, E20, E24
83610030...70	7 BIT SOCKET TX 1/2", 100MML T30, T40, T45, T50, T55, T60, T70
83710030...70	7 BIT SOCKET TAMPERPROOF 1/2", TX 100MML T30H, T40H, T45H, T50H, T55H, T60H, T70H

302104

BIT SOCKET SET 1/2", SFS 1/3 21-PCS

ART. NO.	CONTENTS
83410006...17	8 BIT SOCKET HEX 1/2", 100MML 6, 7, 8, 9, 10, 12, 14, 17MM
83810005...16	8 BIT SOCKET SPLINE 1/2", 100MML M5, M6, M8, M9, M10, M12, M14, M16
83910008...14	5 BIT SOCKET RIBE 1/2", 100MML M8, M9, M10, M12, M14

601017

FLARE NUT WRENCH SET SFS 1/3, 10-PCS

ART. NO.	CONTENTS
4110810...2427	7 FLARE NUT WRENCH 8X10, 11X13, 12X14, 16X18, 17X19, 19X22, 24X27MM
4080809...1213	3 FLEXIBLE FLARE NUT WRENCH 8X9, 10X11, 12X13MM

600708

HINGED SOCKET WRENCH SET SFS 1/3, 7-PCS

ART. NO.	CONTENTS
4120607...1819	7 HINGED SOCKET WRENCH 6X7, 8X9, 10X11, 12X13, 14X15, 16X17, 18X19MM

601103

ANGLE WRENCH SET SFS 1/3, 11-PCS

ART. NO.	CONTENTS
41308...19	11 ANGLE WRENCH 6PT. 8, 10, 11, 12, 13, 14, 15, 16, 17, 18, 19MM

601016

DOUBLE OPEN WRENCH SET SFS 1/3, 10-PCS

ART. NO.	CONTENTS
4140607...3032	10 DOUBLE OPEN WRENCH 6X7, 8X9, 10X11, 12X13, 14X15, 16X17, 18X19, 20X22, 24X27, 30X32MM

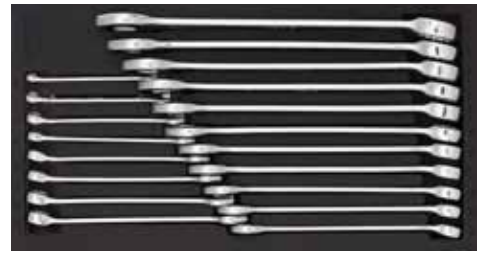
601903

COMBINATION WRENCH SET SFS 1/3, 19-PCS

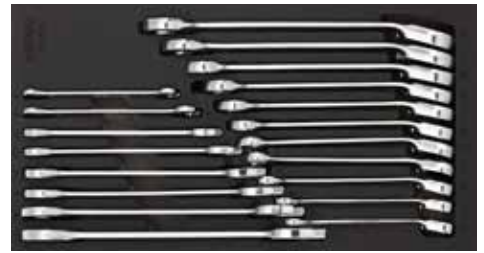
ART. NO.	CONTENTS
41506...24	19 COMBINATION WRENCH 6, 7, 8, 9, 10, 11, 12, 13, 14, 15, 16, 17, 18, 19, 20, 21, 22, 23, 24MM

601904

REVERSIBLE RATCHETING & OPEN WRENCH SET SFS 1/3, 19-PCS

ART. NO.	CONTENTS
4140607...2022	8 DOUBLE OPEN WRENCH 6X7, 8X9, 10X11, 12X13, 14X15, 16X17, 18X19, 20X22MM
4170208...19	11 REVERSIBLE RATCHETING WRENCH 12PT 8, 9, 10, 11, 12, 13, 14, 15, 16, 17, 19MM

601231

12PCS 6PT. FLAT RATCHETING WRENCH SET SFS 1/3

ART. NO.	CONTENTS
4170408...19	12 FLAT RATCHETING WRENCH 6PT. 8, 9, 10, 11, 12, 13, 14, 15, 16, 17, 18, 19MM

601228



12PT. FLAT RING RATCHET SET SFS 1/3 12-PCS

ART. NO.	CONTENTS
4170108...19	12 FLAT RATCHETING WRENCH 12PT. 8, 9, 10, 11, 12, 13, 14, 15, 16, 17, 18, 19MM

601225



WRENCH SET SFS 1/3, 12-PCS

ART. NO.	CONTENTS
4190607...2022	8 75° OFFSET RING WRENCH 6X7, 8X9, 10X11, 12X13, 14X15, 16X17, 18X19, 20X22MM
4160608...2024	4 TX WRENCH E6XE8, E10XE12, E14XE18, E20XE24

602205



OIL FILTER SET SFS 1/3, 22-PCS

ART. NO.	CONTENTS
302001	20 20 PCS 1/2" OIL DRAIN SET
4830801	1 3 JAW OIL FILTER WRENCH
4450250	1 OIL FILTER PLIERS 10"

601229



12PT. REVERSIBLE RATCHETING WRENCH SET 1/3 SFS, 12-PCS

ART. NO.	CONTENTS
4170208...19	12 REVERSIBLE RATCHETING WRENCH 12PT. 8, 9, 10, 11, 12, 13, 14, 15, 16, 17, 18, 19MM

600435



75° OFFSET RING WRENCH SET SFS 1/3, 4-PCS

ART. NO.	CONTENTS
4192123...3032	4 75° OFFSET RING WRENCH 21X23, 24X27, 25X28, 30X32MM

600432



PLIERS SET SFS 1/3, 4-PCS

ART. NO.	CONTENTS
4311175	1 COMBINATION PLIERS 7"
4321200	1 LONG NOSE PLIERS 8"
4331200	1 BENT LONG NOSE PLIERS 8"
4341175	1 DIAGONAL PLIERS 7"

601232



6PT. FLEXIBLE RATCHETING WRENCH SET SFS 1/3, 12-PCS

ART. NO.	CONTENTS
4170608...19	12 FLEXIBLE RATCHETING WRENCH 6PT. 8, 9, 10, 11, 12, 13, 14, 15, 16, 17, 18, 19

603004



WRENCH SET SFS 1/3, 30-PCS

ART. NO.	CONTENTS
42608...17	10 STUBBY COMBINATION WRENCH 8, 9, 10, 11, 12, 13, 14, 15, 16, 17MM
42301250	1 ADJUSTABLE WRENCH 10"
601008	10 HEX BALL EXTRA LONG KEY SET 10-PCS, 1.27, 1.5, 2, 2.5, 3, 4, 5, 6, 8, 10MM
600902	9 9-PCS STAR EXTRA LONG KEY SET

600434



VDE PLIERS SET SFS 1/3, 4-PCS

ART. NO.	CONTENTS
4312180	1 VDE COMBIMAX COMBINATION PLIERS
4322200	1 VDE LONG NOSE PLIERS
4342160	1 VDE DIAGONAL PLIERS
4472160	1 VDE STRIPPING PLIERS

601230



12PT. FLEXIBLE RATCHETING WRENCH SET SFS 1/3, 12-PCS

ART. NO.	CONTENTS
4170308...19	12 FLEXIBLE RATCHETING WRENCH 12PT. 8, 9, 10, 11, 12, 13, 14, 15, 16, 17, 18, 19MM

600709



COMBINATION WRENCH SET SFS 1/3, 7-PCS

ART. NO.	CONTENTS
41525...32	7 COMBINATION WRENCH 25, 26, 27, 28, 29, 30, 32MM

600430

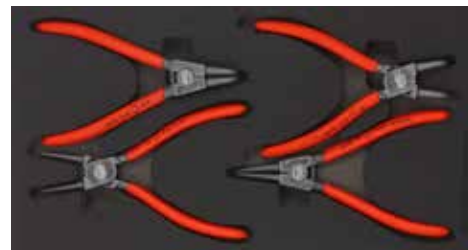

SNAP RING PLIERS SET SFS 1/3, 4-PCS

ART. NO.	CONTENTS
43611	1 SNAP RING PLIERS (STRAIGHT-OPEN)
43612	1 SNAP RING PLIERS (STRAIGHT-CLOSE)
43613	1 SNAP RING PLIERS (BENT-OPEN)
43614	1 SNAP RING PLIERS (BENT-CLOSE)

600825

PLIERS SET SFS 1/3, 8-PCS

ART. NO.	CONTENTS
4311175	1 COMBINATION PLIERS 7"
4321200	1 LONG NOSE PLIERS 8"
4331200	1 BENT LONG NOSE PLIERS 8"
4341175	1 DIAGONAL PLIERS 7"
43611	1 SNAP RING PLIERS (STRAIGHT-OPEN)
43612	1 SNAP RING PLIERS (STRAIGHT-CLOSE)
43613	1 SNAP RING PLIERS (BENT-OPEN)
43614	1 SNAP RING PLIERS (BENT-CLOSE)

600614

FILE SET SFS 1/3, 6-PCS

ART. NO.	CONTENTS
46905	1 TRIANGULAR FILE FOR BRAKES 8"
46913	1 ROUND FILE 8"
46914	1 TRIANGULAR FILE 8"
47003	1 STAINLESS STEEL VERNIER CALIPER
47004	1 STAINLESS STEEL STRAIGHT RULE 30CM
4811254	1 STEEL WIRE BRUSH

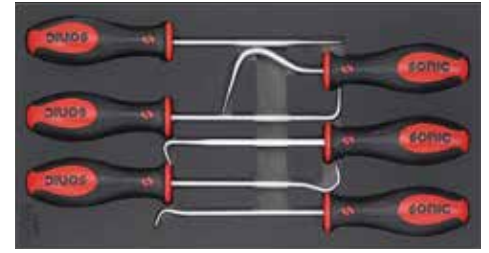
600623

HOOK SET SFS 1/3, 8-PCS

ART. NO.	CONTENTS
47904	1 COTTER PIN PULLER
47905	1 RADIATOR HOSE REMOVER
47909	1 STRAIGHT PICK HOOK
47910	1 DEGREE HOOK
47911	1 FULL HOOK
49712	1 SMALL ANGLE HOOK

600319

HAMMER SET SFS 1/3 3-PCS

ART. NO.	CONTENTS
4611400	1 MACHINIST HAMMER 400GR. FIBRE HANDLE TPR COVER
4620400	1 SAND FILLED HAMMER 400GR.
4631000	1 STONING HAMMER 1000GR. FIBRE HANDLE TPR COVER

600705

PLIERS & TOOLS SET SFS 1/3, 7-PCS

ART. NO.	CONTENTS
4351250	1 WATERPUMP PLIERS 10"
4380250	1 LOCKING PLIERS 10"
46807	1 UTILITY KNIFE INCL. 5 BLADES
4821301	1 WEDGE UNIVERSAL (190X30MM)
47002	1 FEELER GAUGE 26-PCS
47013	1 MEASURING TAPE 5 METER
4820110	1 MAGNET FLEXIBLE

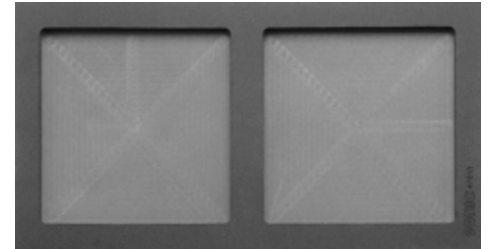
47613

SFS 1/3 FOAM SPACER 190X370MM

ART. NO.	CONTENTS
47613	1 SFS 1/3 FOAM SPACER

601227

GRIPPED CHISEL & PUNCH SET SFS 1/3, 12-PCS

ART. NO.	CONTENTS
45112160	1 GRIP CHISEL 160MML 12
45116170	1 GRIP CHISEL 170MML 16
45118190	1 GRIP CHISEL 190MML 18
45124220	1 GRIP CHISEL 220MML 24
4527190	1 GRIP CAPE CHISEL 190MML 7
4533150	1 GRIP PIN PUNCH 150MML 3
4534180	1 GRIP PIN PUNCH 180MML 4
4535200	1 GRIP PIN PUNCH 200MML 5
4536210	1 GRIP PIN PUNCH 210MML 6
4553185	1 GRIP TAPER PUNCH 185MML 3
4554185	1 GRIP TAPER PUNCH 185MML 4
4564185	1 GRIP CENTER PUNCH 185MML 4

600822

HOOK SET SFS 1/3, 8-PCS

ART. NO.	CONTENTS
47901	1 DOOR UPHOLSTERY PANEL REMOVER SMALL 100MML
47902	1 DOOR UPHOLSTERY PANEL REMOVER 110MML
47903	1 SCRAPER
47904	1 COTTER PIN PULLER
47905	1 RADIATOR HOSE REMOVER
47906	1 TRIM PAD TOOL 1/4" X 115MML
47907	1 TRIM PAD TOOL 5/16" X 115MML
47908	1 DOOR UPHOLSTERY PANEL REMOVER 132MML

106304



E1/3, 1/4" SOCKET BIT SAE SET, 63-PCS

ART. NO.	CONTENTS
21905...13	9 1/4" 12PT. FLANK SOCKET 3/16", 7/32", 1/4", 9/32", 5/16", 11/32", 3/8", 7/16", 1/2"
21604...10	6 1/4" STAR SOCKET E4, E5, E6, E7, E8, E10
601006	10 10-PCS HEX BALL LONG KEY SET
7120901	1 1/4" RATCHET HANDLE-45 TEETH
7110301	1 1/4" DISC RATCHET-72 TEETH
72401	1 1/4" SPINNER 150MML-6"
7141050...150	3 1/4" EXTENSION 50, 100, 150MML
71511	1 1/4" UNIVERSAL JOINT
72225	1 1/4" MAGNETIC SOCKET PICK-UP
8113701...02	2 1/4" PHILLIPS SOCKET BIT PH.1, PH.2
81413703...08	6 1/4" HEX SOCKET BIT 1/8", 5/32", 3/16", 7/32", 1/4", 5/16"
8163706...40	11 1/4" STAR SOCKET BIT T6, T7, T8, T9, T10, T15, T20, T25, T27, T30, T40
8173706...40	11 1/4" STAR T. SOCKET BIT T6H, T7H, T8H, T9H, T10H, T15H, T20H, T25H, T27H, T30H, T40H

204102



E1/3, 3/8" SOCKET BIT SAE SET, 41-PCS

ART. NO.	CONTENTS
22906...18	10 3/8" 12PT. FLANK SOCKET 1/4", 5/16", 3/8", 7/16", 1/2", 9/16", 5/8", 11/16", 3/4", 13/16"
22607...18	8 3/8" STAR SOCKET E7, E8, E10, E11, E12, E14, E16, E18
7120902	1 3/8" RATCHET HANDLE-45 TEETH
7110302	1 3/8" DISC RATCHET-72 TEETH
7172214	1 3/8" 12PT. SPARK PLUG CLIP SOCKET 14
7171216	3 3/8" SPARK PLUG SOCKET 16, 18, 21
7142044...75	2 3/8" EXTENSION 44, 75MML
7142150...200	2 3/8" EXTENSION 150, 200MML
71521	1 3/8" UNIVERSAL JOINT
82414805...12	6 3/8" HEX SOCKET BIT 3/16", 7/32", 1/4", 5/16", 3/8", 7/16"
8264825...50	6 3/8" STAR SOCKET BIT T25, T27, T30, T40, T45, T50

202302



E1/3, 3/8" LONG SOCKET SAE SET, 23-PCS

ART. NO.	CONTENTS
2296310...21	8 3/8" 12PT. FLANK DEEP SOCKET 3/8", 7/16", 1/2", 9/16", 5/8", 11/16", 3/4", 13/16"
7152610...16	4 3/8" STAR CARDAN SOCKET E10, E12, E14, E16
71521	1 3/8" UNIVERSAL JOINT
2266306...20	10 3/8" STAR DEEP SOCKET E6, E7, E8, E10, E11, E12, E14, E16, E18, E20

302005



E1/3, 1/2" COMBINATION SAE SET, 20-PCS

ART. NO.	CONTENTS
23910...32	15 1/2" 12PT. FLANK SOCKET 3/8", 7/16", 1/2", 9/16", 5/8", 11/16", 3/4", 13/16", 7/8", 15/16", 1", 1.1/16", 1.1/8", 1.3/16", 1.1/4"
7120903	1 1/2" RATCHET HANDLE-45 TEETH
7143125...250	2 1/2" EXTENSION 125, 250MML
71531	1 1/2" UNIVERSAL JOINT
71623	1 ADAPTOR FOR EXT. 3/8"(F)X1/2"(M)

302004



E1/3, 1/2" DEEP SOCKET SAE SET, 20-PCS

ART. NO.	CONTENTS
2397710...32	15 1/2" 12PT. FLANK DEEP SOCKET 3/8", 7/16", 1/2", 9/16", 5/8", 11/16", 3/4", 13/16", 7/8", 15/16", 1", 1.1/16", 1.1/8", 1.3/16", 1.1/4"
2367714...22	5 1/2" STAR DEEP SOCKET E14, E16, E18, E20, E22

303806



E1/3, 1/2" SOCKET BIT SAE SET, 38-PCS

ART. NO.	CONTENTS
23910...32	15 1/2" 12PT. FLANK SOCKET 3/8", 7/16", 1/2", 9/16", 5/8", 11/16", 3/4", 13/16", 3/4", 7/8", 15/16", 1", 1.1/16", 1.1/8", 1.3/16", 1.1/4"
23610...24	8 1/2" STAR SOCKET E10, E11, E12, E14, E16, E18, E20, E24
834106205...17	10 1/2" HEX SOCKET BIT 3/16", 1/4", 9/32", 5/16", 11/32", 3/8", 7/16", 1/2", 9/16", 5/8"
83606245...70	5 1/2" STAR SOCKET BIT T45, T50, T55, T60, T70

601406



E1/3 COMBINATION WRENCH SAE SET, 14-PCS

ART. NO.	CONTENTS
4150206...27	14 COMBINATION WRENCH 1/4", 5/16", 3/8", 7/16", 1/2", 9/16", 5/8", 11/16", 3/4", 13/16", 7/8", 15/16", 1", 1.1/16"

603506



SCREWDRIVER SET SFS, 35-PCS

ART. NO.	CONTENTS
1311...3	3 SCREWDRIVER PH.1, PH.2, PH.3
13115...25	2 SCREWDRIVER, STUBBY PH.1, PH.2
13303...08	5 SCREWDRIVER, SLOTTED 3, 4, 5.5, 6.5, 8MM
1330555	1 SCREWDRIVER, STUBBY SLOTTED 5.5MM
13606...30	10 SCREWDRIVER, TX T6, T7, T8, T9, T10, T15, T20, T25, T27, T30
1950205...08	3 T-HANDLE BALL ENDED HEXAGON KEY WRENCH, EXTRA LONG 5, 6, 8MM
17320002	1 ELECTRONIC SCREWDRIVER 2MM
601008	10 HEX BALL EXTRA LONG KEY SET 10-PCS, 1.27, 1.5, 2, 2.5, 3, 4, 5, 6, 8, 10MM

604102



SCREWDRIVER SET SFS, 41-PCS

ART. NO.	CONTENTS
1310...3	4 PHILLIPS SCREWDRIVER PH.0, PH.1, PH.2, PH.3
13125	1 PHILLIPS STUBBY SCREWDRIVER PH.2
13304...08	4 SLOTTED SCREWDRIVER 4, 5.5, 6.5, 8MM
1330555	1 SLOTTED STUBBY SCREWDRIVER 5.5MM
13608...40	9 STAR SCREWDRIVER T8, T9, T10, T15, T20, T25, T27, T30, T40
47536...08	3 FLEXIBLE HEX NUT DRIVER 6, 7, 8MM
600902	9 9-PCS STAR EXTRA LONG KEY SET
600912	9 9-PCS HEX BALL STUBBY KEY SET
12425010	1 HEX NUT DRIVER 10MM

602708

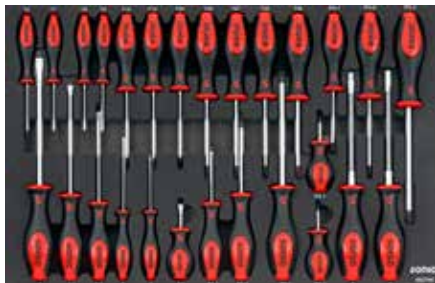

SCREWDRIVERS SET SFS, 27-PCS

ART. NO.	CONTENTS
1311...13	3 SCREWDRIVER PH.1, PH.2, PH.3
13115	1 SCREWDRIVER, STUBBY PH.1
1321...23	3 SCREWDRIVER PZ.1, PZ.2, PZ.3
13215	1 SCREWDRIVER, STUBBY PZ.1
13303...08	5 SCREWDRIVER, SLOTTED 3, 4, 5.5, 6.5, 8MM
1330555	1 SCREWDRIVER, STUBBY SLOTTED 5.5MM
13606...40	11 SCREWDRIVER, TX T6, T7, T8, T9, T10, T15, T20, T25, T27, T30, T40
47536...07	2 FLEXIBLE SOCKET SCREWDRIVER, HEX 6, 7MM

602709

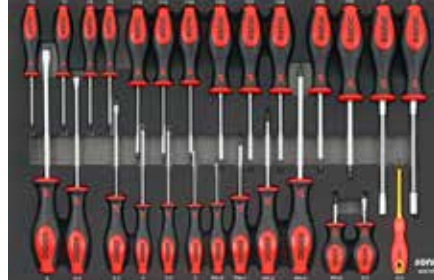

SCREWDRIVERS SET SFS, 27-PCS

ART. NO.	CONTENTS
1310...3	4 SCREWDRIVER PH.0, PH.1, PH.2, PH.3
13125	1 SCREWDRIVER, STUBBY PH.2
13303...08	6 SCREWDRIVER, SLOTTED 3, 3.5, 4, 5.5, 6.5, 8MM
1330555	1 SCREWDRIVER, STUBBY SLOTTED 5.5MM
16325	1 VDE SCREWDRIVER, SLOTTED 2.5MM
136...45	12 SCREWDRIVER, TX T6, T7, T8, T9, T10, T15, T20, T25, T27, T30, T40, T45
47537...38	2 FLEXIBLE SOCKET SCREWDRIVER, HEX 7, 8MM

602407

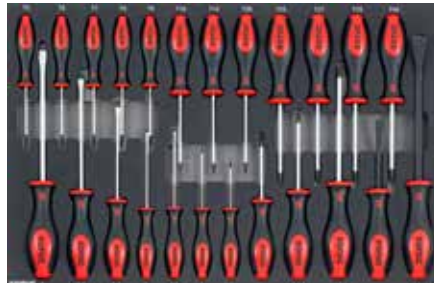

SCREWDRIVER SET SFS, 24-PCS

ART. NO.	CONTENTS
13605...40	12 SCREWDRIVER, TX T5, T6, T7, T8, T9, T10, T15, T20, T25, T27, T30, T40
13303...08	6 SCREWDRIVER, SLOTTED 3, 3.5, 4, 5.5, 6.5, 8MM
1310...3	4 SCREWDRIVER, PH.0, PH.1, PH.2, PH.3
4821308...12	2 PRY BAR 200MM 8", 300MM 12"

112102



COMBINATION SET 1/4", SFS 121-PCS

ART. NO.	CONTENTS
13303...08	6 SCREWDRIVER, SLOTTED 3, 3.5, 4, 5.5, 6.5, 8MM
1310...3	4 SCREWDRIVER PH.0, PH.1, PH.2, PH.3
4821308	1 PRY BAR 200MM 8"
601001	16 IN 1 RATCHET SCREWDRIVER
21504...13	12 FLANK SOCKET 1/4", 6 PT. 4, 4.5, 5, 5.5, 6, 7, 8, 9, 10, 11, 12, 13MM
2155004...13	12 FLANK DEEP SOCKET 1/4", 6 PT. 4, 4.5, 5, 5.5, 6, 7, 8, 9, 10, 11, 12, 13MM
21604...10	6 SOCKET 1/4", TX E4, E5, E6, E7, E8, E10
2165004...10	6 SOCKET 1/4", TX DEEP E4, E5, E6, E7, E8, E10
8143703...10	7 BIT SOCKET HEX 1/4", 3, 4, 5, 6, 7, 8, 10MM
8153710...40	7 TAMPER-RESISTANT 1/4" TX PLUS (5 LOBES) 10IPR, 15IPR, 20IPR, 25IPR, 27IPR, 30IPR, 40IPR
8163708...40	8 BIT SOCKET TX 1/4", T8, T10, T15, T20, T25, T27, T30, T40
8173708...40	8 BIT SOCKET TX TAMPERPROOF 1/4", T8H, T10H, T15H, T20H, T25H, T27H, T30H, T40H
600902	9 KEY WRENCH TX, EXTRA LONG SET 9-PCS, T15, T20, T25, T27, T30, T40, T45, T50
601008	10 HEX BALL EXTRA LONG KEY SET 10-PCS, 1.27, 1.5, 2, 2.5, 3, 4, 5, 6, 8, 10MM
7110101	1 FLEXIBLE RATCHET 1/4", 45 TEETH
7110301	1 DISC RATCHET 1/4", 72 TEETH
7120701	1 RATCHET HANDLE 1/4" 72 TEETH
7120901	1 RATCHET HANDLE 1/4" 45 TEETH
7141050...150	3 EXTENSION 1/4" 50,100,150MML
71511	1 UNIVERSAL JOINT 1/4"
72225	1 MAGNET SOCKET PICK-UP 1/4"

106105



COMBINATION SET 1/4", SCREWDRIVER AND WRENCH SFS 61-PCS

ART. NO.	CONTENTS
1311...12	2 PHILLIPS SCREWDRIVER PH.1, PH.2
13303...65	4 SLOTTED SCREWDRIVER 3, 4, 5.5, 6.5MM
21503...12	12 1/4" 6PT. FLANK SOCKET 3, 4, 4.5, 5, 5.5, 6, 7, 8, 9, 10, 11, 12MM
2155008...13	6 1/4" 6PT. FLANK DEEP SOCKET 8, 9, 10, 11, 12, 13MM
41506...24	18 COMBINATION WRENCH 6, 7, 8, 9, 10, 11, 12, 13, 14, 15, 16, 17, 18, 19, 20, 21, 22, 24MM
7110301	1 1/4" DISC RATCHET-72 TEETH
7120901	1 1/4" RATCHET HANDLE-45 TEETH
7131115	1 1/4" SLIDING T HANDLE
7141050...100	2 1/4" EXTENSION 50, 100MML
71511	1 1/4" UNIVERSAL JOINT
72401	1 1/4" SPINNER 150MML
8143703...07	6 1/4" HEX SOCKET BIT 3, 4, 5, 5.5, 6, 7MM
8163710...30	6 1/4" STAR SOCKET BIT T10, T15, T20, T25, T27, T30

602904



SCREWDRIVERS & WRENCH SET SFS, 29-PCS

ART. NO.	CONTENTS
1311...2	2 SCREWDRIVER PH.1, PH.2
13303...08	6 SCREWDRIVER, SLOTTED 3, 3.5, 4, 5.5, 6.5, 8MM
41506...32	21 COMBINATION WRENCH 6, 7, 8, 9, 10, 11, 12, 13, 14, 15, 16, 17, 18, 19, 20, 21, 22, 24, 27, 30, 32MM

206501



COMBINATION SET 3/8" & 1/2", SFS 65-PCS

ART. NO.	CONTENTS
22506...21	16 3/8" 6PT. FLANK SOCKET 6, 7, 8, 9, 10, 11, 12, 13, 14, 15, 16, 17, 18, 19, 20, 21MM
2256310...17	6 3/8" 6PT. FLANK DEEP SOCKET 10, 13, 14, 15, 16, 17MM
7110302	1 3/8" DISC RATCHET-72 TEETH
7120902	1 3/8" RATCHET HANDLE-45 TEETH
7142075...250	3 3/8" EXTENSION 75, 150, 250MML
71521	1 3/8" UNIVERSAL JOINT
7171216...21	2 3/8" SPARK PLUG SOCKET 16, 21MM
8244805...10	7 3/8" HEX SOCKET BIT 5, 5.5, 6, 7, 8, 9, 10MM
8264820...50	7 3/8" STAR SOCKET BIT T20, T25, T27, T30, T40, T45, T50
23516...32	11 1/2" 6PT. FLANK SOCKET 16, 17, 18, 19, 20, 21, 22, 24, 27, 30, 32MM
2357713...22	5 1/2" 6PT. FLANK DEEP SOCKET 13, 14, 17, 19, 22MM
7120903	1 1/2" RATCHET HANDLE-45 TEETH
7143125...250	2 1/2" EXTENSION 125, 250MML
71531	1 1/2" UNIVERSAL JOINT
71632	1 ADAPTOR FOR EXTENSION 1/2"(F) X 3/8"(M)

214201



SOCKET COMBINATON SET 1/4" & 3/8", SFS 142-PCS

ART. NO.	CONTENTS
21503...14	12 FLANK SOCKET 1/4" 6 PT. 3, 5, 5.5, 6, 7, 8, 9, 10, 11, 12, 13, 14MM
2155004...13	12 FLANK DEEP SOCKET 1/4" 6 PT. 4, 4.5, 5, 5.5, 6, 7, 8, 9, 10, 11, 12, 13MM
21604...10	6 SOCKET 1/4", TX, E4, E5, E6, E7, E8, E10
7120901	1 RATCHET HANDLE 1/4" 45 TEETH
7131115	1 SLIDING T HANDLE 1/4"
71511	1 UNIVERSAL JOINT 1/4"
7141050...150	3 EXTENSION 1/4" 50, 100, 150MML
7261250	1 WOBBLE EXTENSION 1/4" 250MML
7151608	1 CARDAN SOCKET 1/4", TX E8
71912	1 ADAPTOR 1/4"(F) X 3/8"(M)
72225	1 MAGNET SOCKET PICK-UP 1/4"
72401	1 SPINNER 1/4" 150MML
8113701...03	3 BIT SOCKET PH 1/4", PH.1, PH.2, PH.3
8133704...065	3 BIT SOCKET SLOTTED 1/4", 4, 5.5, 6.5MM
8143703...08	5 BIT SOCKET HEX 1/4", 3, 4, 5, 6, 8MM
8163710...40	7 BIT SOCKET TX 1/4" T10, T15, T20, T25, T27, T30, T40
22507...22	16 FLANK SOCKET 3/8" 6 PT. 7, 8, 9, 10, 11, 12, 13, 14, 15, 16, 17, 18, 19, 20, 21, 22MM
2256308...21	14 FLANK SOCKET 3/8" 6 PT. DEEP 8, 9, 10, 11, 12, 13, 14, 15, 16, 17, 18, 19, 20, 21MM
22605...14	8 SOCKET 3/8", TX E5, E6, E7, E8, E10, E11, E12, E14
7110102	1 FLEXIBLE RATCHET 3/8", 45 TEETH
7120902	1 RATCHET HANDLE 3/8" 45 TEETH
7142075...250	3 EXTENSION 3/8" 75, 150, 250MML
7152610	1 TX CARDAN 3/8" SOCKET E10
7152810...16	7 CARDAN SOCKET 3/8", 10, 11, 12, 13, 14, 15, 16MM
71521	1 UNIVERSAL JOINT 3/8"
71921	1 ADAPTOR 3/8"(F) X 1/4"(M)
71932	1 ADAPTOR 1/2"(F) X 3/8"(M)
7172216...21	3 SPARK PLUG 3/8" CLIP SOCKET 16, 18, 21MM
8244803...10	9 BIT SOCKET HEX 3/8", 3, 4, 5, 5.5, 6, 7, 8, 9, 10MM
8264815...55	9 BIT SOCKET TX 3/8", T15, T20, T25, T27, T30, T40, T45, T50, T55
8269025	1 BIT SOCKET TX 3/8", 90MML T25
8284804...12	7 BIT SOCKET SPLINE 3/8", M4, M5, M6, M8, M9, M10, M12

213901



SOCKET COMBINATON SET 1/4" & 3/8", SFS 139-PCS

ART. NO.	CONTENTS
21505...14	12 FLANK SOCKET 1/4" 6 PT. 4.5, 5, 5.5, 6, 7, 8, 9, 10, 11, 12, 13, 14MM
600902	9 KEY WRENCH TX, EXTRA LONG SET 9-PCS
7110101	1 FLEXIBLE RATCHET 1/4" 45 TEETH
7120901	1 RATCHET HANDLE 1/4" 45 TEETH
7131115	1 SLIDING T HANDLE 1/4"
7141050...150	2 EXTENSION 1/4" 50, 150MML
71511	1 UNIVERSAL JOINT 1/4"
72401	1 SPINNER 1/4" 150MML
72225	1 MAGNET SOCKET PICK-UP 1/4"
8113700...03	4 BIT SOCKET PH 1/4", PH.0, PH.1, PH.2, PH.3
8133704...65	3 BIT SOCKET SLOTTED 1/4", 4, 5.5, 6.5MM
8143703...08	6 BIT SOCKET HEX 1/4", 3, 4, 5, 6, 7, 8MM
8153710...40	7 TAMPER-RESISTANT 1/4", TX PLUS (5 LOBES) 10IPR, 15IPR, 20IPR, 25IPR, 27IPR, 30IPR, 40IPR
8163706...40	11 BIT SOCKET TX 1/4", T6, T7, T8, T9, T10, T15, T20, T25, T27, T30, T40
8183704...10	5 BIT SOCKET SPLINE 1/4", M4, M5, M6, M8, M10
22506...22	17 FLANK SOCKET 3/8" 6 PT. 6, 7, 8, 9, 10, 11, 12, 13, 14, 15, 16, 17, 18, 19, 20, 21, 22MM
22604...14	9 SOCKET 3/8", TX E4, E5, E6, E7, E8, E10, E11, E12, E14
7110102	1 FLEXIBLE RATCHET 3/8" 45 TEETH
7120902	1 RATCHET HANDLE 3/8" 45 TEETH
7142044...250	4 EXTENSION 3/8" 44, 75, 150, 250MML
71521	1 UNIVERSAL JOINT 3/8"
7172216...21	3 SPARK PLUG 3/8" CLIP SOCKET 16, 18, 21MM
8244803...10	9 BIT SOCKET HEX 3/8", 3, 4, 5, 5.5, 6, 7, 8, 9, 10MM
8264815...55	9 BIT SOCKET TX 3/8", T15, T20, T25, T27, T30, T40, T45, T50, T55
8274815...55	9 BIT SOCKET TX TAMPERPROOF 3/8" T15H, T20H, T25H, T27H, T30H, T40H, T45H, T50H, T55H
8284804...12	7 BIT SOCKET SPLINE 3/8", M4, M5, M6, M8, M9, M10, M12
4160608...2024	4 TX WRENCH E6XE8, E10XE12, E14XE18, E20XE24

215702

COMBINATION SET 1/7", & 3/8", SFS 157-PCS

ART. NO.	CONTENTS
21504...13	12 FLANK SOCKET 1/4", 6 PT. 4, 4.5, 5, 5.5, 6, 7, 8, 9, 10, 11, 12, 13MM
2155004...13	12 FLANK DEEP SOCKET 1/4", 6 PT. 4, 4.5, 5, 5.5, 6, 7, 8, 9, 10, 11, 12, 13MM
21604...10	6 SOCKET 1/4", TX E4, E5, E6, E7, E8, E10
2165004...10	6 SOCKET 1/4", TX DEEP E4, E5, E6, E7, E8, E10
601008	10 HEX BALL EXTRA LONG KEY SET 10-PCS, 1.27, 1.5, 2, 2.5, 3, 4, 5, 6, 8, 10MM
600902	9 KEY WRENCH TX, EXTRA LONG SET 9-PCS
7110101	1 FLEXIBLE RATCHET 1/4", 45 TEETH
7110301	1 DISC RATCHET 1/4", 72 TEETH
7120701	1 RATCHET HANDLE 1/4" 72 TEETH
7120901	1 RATCHET HANDLE 1/4" 45 TEETH
7141050...150	3 EXTENSION 1/4" 50, 100, 150MML
71511	1 UNIVERSAL JOINT 1/4"
72225	1 MAGNET SOCKET PICK-UP 1/4"
8143703...08	7 BIT SOCKET HEX 1/4", 3, 4, 5, 5.5, 6, 7, 8MM
8153710...40	7 TAMPER-RESISTANT 1/4", TX PLUS (5 LOBES) 10IPR, 15IPR, 20IPR, 25IPR, 27IPR, 30IPR, 40IPR
8163706...25	8 BIT SOCKET TX 1/4", T6, T7, T8, T9, T10, T15, T20, T25
8173706...25	8 BIT SOCKET TX TAMPERPROOF 1/4", T6H, T7H, T8H, T9H, T10H, T15H, T20H, T25H
22506...22	17 FLANK SOCKET 3/8", 6 PT. 6, 7, 8, 9, 10, 11, 12, 13, 14, 15, 16, 17, 18, 19, 20, 21, 22MM
22604...14	9 SOCKET 3/8" TX E4, E5, E6, E7, E8, E10, E11, E12, E14
7110302	1 DISC RATCHET 3/8" 72 TEETH
7120902	1 RATCHET HANDLE 3/8" 45 TEETH
7142075...250	3 EXTENSION 3/8" 75, 150, 250MML
71521	1 UNIVERSAL JOINT 3/8"
71632	1 ADAPTOR FOR EXT. 1/2"(F)X3/8"(M)
7171216...21	3 SPARK PLUG SOCKET 3/8" 16, 18, 21MM
8244803...10	9 BIT SOCKET HEX 3/8", 3, 4, 5, 5.5, 6, 7, 8, 9, 10MM
8264815...55	9 BIT SOCKET TX 3/8" T15, T20, T25, T27, T30, T40, T45, T50, T55
8274815...55	9 BIT SOCKET TX TAMPERPROOF 3/8" T15H, T20H, T25H, T27H, T30H, T40H, T45H, T50H, T55H

316001

COMBINATION SET 1/4", 3/8" & 1/2", SFS 160-PCS

ART. NO.	CONTENTS
21503...13	13 FLANK SOCKET 1/4" 6 PT. 3, 4, 4.5, 5, 5.5, 6, 7, 8, 9, 10, 11, 12, 13MM
2155005...13	9 FLANK DEEP SOCKET 1/4", 6 PT. 5, 6, 7, 8, 9, 10, 11, 12, 13MM
22506...21	16 FLANK SOCKET 3/8", 6 PT. 6, 7, 8, 9, 10, 11, 12, 13, 14, 15, 16, 17, 18, 19, 20, 21MM
23508...32	21 FLANK SOCKET 3/8" 6 PT. 8, 10, 11, 12, 13, 14, 15, 16, 17, 18, 19, 20, 21, 22, 23, 24, 25, 27, 28, 30, 32MM
600902	9 KEY WRENCH TX, EXTRA LONG SET 9-PCS
601008	10 HEX BALL EXTRA LONG KEY SET 10-PCS, 1.27, 1.5, 2, 2.5, 3, 4, 5, 6, 8, 10MM
72401	1 SPINNER 1/4" 150MML
7120901	1 RATCHET HANDLE 1/4" 45 TEETH
7141050...100	2 EXTENSION 1/4" 50, 100MML
71511	1 UNIVERSAL JOINT 1/4"
8113701...02	2 BIT SOCKET PH 1/4", PH.1, PH.2
8143703...10	9 BIT SOCKET HEX 1/4", 3, 4, 5, 5.5, 6, 7, 8, 9, 10MM
8163708...40	8 BIT SOCKET TX 1/4", T8, T10, T15, T20, T25, T27, T30, T40
8183704...10	5 BIT SOCKET SPLINE 1/4", M4, M5, M6, M8, M10
7120902	1 RATCHET HANDLE 3/8" 45 TEETH
7142075...150	2 EXTENSION 3/8" 75, 250MML
71521	1 UNIVERSAL JOINT 3/8"
72023	1 BIT HOLDER 3/8"(F) X 10MM(F)
7171216...21	2 SPARK PLUG SOCKET 3/8" 16, 21MM
7120903	1 RATCHET HANDLE 1/2" 45 TEETH
7133250	1 SLIDING T HANDLE 1/2"
7143125...250	2 EXTENSION 1/2" 125, 250MML
71531	1 UNIVERSAL JOINT 1/2"
72033	1 BIT HOLDER 1/2"(F) X 10MM(F)
9343004...12	7 BIT HEX 10MM, 30MML 4, 5, 6, 7, 8, 10, 12
9347504...12	7 BIT HEX 10MM, 75MML 4, 5, 6, 7, 8, 10, 12
9363020...60	8 BIT TX 10MM, 30MML T20, T25, T30, T40, T45, T50, T55, T60
9367520...60	8 BIT TX 10MM, 75MML T20, T25, T30, T40, T45, T50, T55, T60
9383005...12	5 BIT SPLINE 10MM, 30MML M5, M6, M8, M10, M12
9387505...12	5 BIT SPLINE 10MM, 75MML M5, M6, M8, M10, M12

313802

BIT SOCKET SET 1/4" & 1/2", SFS 138-PCS

ART. NO.	CONTENTS
21504...14	12 FLANK SOCKET 1/4", 6 PT. 4, 5, 5.5, 6, 7, 8, 9, 10, 11, 12, 13, 14MM
21604...10	6 SOCKET 1/4", TX E4, E5, E6, E7, E8, E10
23510...32	21 FLANK SOCKET 1/2", 6 PT. 10, 11, 12, 13, 14, 15, 16, 17, 18, 19, 20, 21, 22, 23, 24, 25, 26, 27, 28, 30, 32MM
23611...24	7 SOCKET 1/2", TX E11, E12, E14, E16, E18, E20, E24
24936	1 SOCKET 3/4", 12 PT. 36
3310117...19	2 WHEEL SOCKET 1/2", 6PT. 17, 19
1860106...09	4 KEY WRENCH TX, EXTRA LONG T6, T7, T8, T9
600902	9 KEY WRENCH TX, EXTRA LONG SET 9-PCS
601008	10 HEX BALL EXTRA LONG KEY SET 10-PCS, 1.27, 1.5, 2, 2.5, 3, 4, 5, 6, 8, 10MM
7120901	1 RATCHET HANDLE 1/4" 45 TEETH
7131115	1 SLIDING T HANDLE 1/4"
7141050...150	2 EXTENSION 1/4" 50, 150MML
71511	1 UNIVERSAL JOINT 1/4"
72401	1 SPINNER 1/4" 150MML
7120903	1 RATCHET HANDLE 1/2" 45 TEETH
7133250	1 SLIDING T HANDLE 1/2"
7143125...250	2 EXTENSION 1/2" 125, 250MML
71531	1 UNIVERSAL JOINT 1/2"
71934	1 ADAPTOR 1/2"(F) X 3/4"(M)
8113701...03	3 BIT SOCKET PH 1/4", PH.1, PH.2, PH.3
8123701...02	2 BIT SOCKET PZ 1/4", PZ.1, PZ.2
8133704...65	3 BIT SOCKET SLOTTED 1/4", 4, 5.5, 6.5MM
8143703...08	6 BIT SOCKET HEX 1/4", 3, 4, 5, 6, 7, 8MM
8163706...40	11 BIT SOCKET TX 1/4", T6, T7, T8, T9, T10, T15, T20, T25, T27, T30, T40
8173706...40	11 BIT SOCKET TX TAMPERPROOF 1/4", T6H, T7H, T8H, T9H, T10H, T15H, T20H, T25H, T27H, T30H, T40H
83406205...19	9 BIT SOCKET HEX 1/2", 5, 6, 7, 8, 10, 12, 14, 17, 19MM
83606240...60	5 BIT SOCKET TX 1/2", T40, T45, T50, T55, T60
83610025	1 BIT SOCKET TX 1/2", 100MML T25
83806206...10	3 BIT SOCKET SPLINE 1/2", M6, M8, M10

310101



COMBINATION SET 3/8" & 1/2", SFS 101-PCS

ART. NO.	CONTENTS
22506...22	17 FLANK SOCKET 3/8", 6 PT. 6, 7, 8, 9, 10, 11, 12, 13, 14, 15, 16, 17, 18, 19, 20, 21, 22MM
22604...14	9 SOCKET 3/8", TX E4 E5, E6, E7, E8, E10, E11, E12, E14
8244803...10	9 BIT SOCKET HEX 3/8", 3, 4, 5, 5.5, 6, 7, 8, 9, 10MM
8264815...55	9 BIT SOCKET TX 3/8" T15, T20, T25, T27, T30, T40, T45, T50, T55
8274815...55	9 BIT SOCKET TX TAMPERPROOF 3/8" T15H, T20H, T25H, T27H, T30H, T40H, T45H, T50H, T55H
7110302	1 DISC RATCHET 3/8", 72 TEETH
7120902	1 RATCHET HANDLE 3/8" 45 TEETH
7142075...250	3 EXTENSION 3/8" 75, 150, 250MML
71521	1 UNIVERSAL JOINT 3/8"
71632	1 ADAPTOR FOR EXT. 1/2"(F) X 3/8"(M)
7171216...21	3 SPARK PLUG SOCKET 3/8" 16, 18, 21MM
23508...32	24 FLANK SOCKET 1/2", 6 PT. 8, 9, 10, 11, 12, 13, 14, 15, 16, 17, 18, 19, 20, 21, 22, 23, 24, 25, 26, 27, 28, 29, 30, 32MM
23610...24	9 SOCKET 1/2", TX E10, E11, E12, E14, E16, E18, E20, E22, E24
7120903	1 RATCHET HANDLE 1/2" 45 TEETH
7143125...250	2 EXTENSION 1/2", 125, 250MML
71531	1 UNIVERSAL JOINT 1/2"
71623	1 ADAPTOR FOR EXT. 3/8"(F) X 1/2"(M)

309502



COMBINATION SET 1/2", SFS 95-PCS

ART. NO.	CONTENTS
23508...32	24 FLANK SOCKET 1/2", 6 PT. 8, 9, 10, 11, 12, 13, 14, 15, 16, 17, 18, 19, 20, 21, 22, 23, 24, 25, 26, 27, 28, 29, 30, 32MM
23610...24	9 SOCKET 1/2", TX E10, E11, E12, E14, E16, E18, E20, E22, E24
7120903	1 RATCHET HANDLE 1/2" 45 TEETH
71623	1 ADAPTOR FOR EXT. 3/8"(F) X 1/2"(M)
7143125...250	2 EXTENSION 1/2" 125, 250MML
71531	1 UNIVERSAL JOINT 1/2"
7233380	1 SWIVEL HANDLE 1/2" 380MML
83406206...17	8 BIT SOCKET HEX 1/2", 6, 7, 8, 9, 10, 12, 14, 17MM
83410006...17	8 BIT SOCKET HEX 1/2", 100MML 6, 7, 8, 9, 10, 12, 14, 17MM
83606227...70	8 BIT SOCKET TX 1/2" T27, T30, T40, T45, T50, T55, T60, T70
83610027...70	8 BIT SOCKET TX 1/2", 100MML T27, T30, T40, T45, T50, T55, T60, T70
83706227...70	8 BIT SOCKET TAMPERPROOF 1/2", TX T27H, T30H, T40H, T45H, T50H, T55H, T60H, T70H
83806205...16	8 BIT SOCKET SPLINE 1/2" M5, M6, M8, M9, M10, M12, M14, M16
83806216T	1 BIT SOCKET SPLINE 1/2", M16-T
83906208...14	7 BIT SOCKET RIBE 1/2" M8, M9, M10, M11, M12, M13, M14

306101



COMBINATION SET 1/2", SFS 61-PCS

ART. NO.	CONTENTS
23510...32	19 FLANK SOCKET 1/2", 6 PT. 10, 11, 12, 13, 14, 15, 16, 17, 18, 19, 20, 21, 22, 24, 26, 27, 28, 30, 32MM
23809...13	3 SOCKET 1/2", 12 PT. 9, 10, 13MM
3310117...19	2 WHEEL SOCKET 1/2", 6PT. 17, 19MM
7120903	1 RATCHET HANDLE 1/2" 45 TEETH
7133250	1 SLIDING T HANDLE 1/2", 250MML
7143125...250	2 EXTENSION 1/2", 125MML, 250MML
7263050...250	3 WOBBLE EXTENSION 1/2", 50, 125, 250MML
71531	1 UNIVERSAL JOINT 1/2"
71623	1 ADAPTOR FOR EXTENSION 3/8"(F) X 1/2"(M)
83010005...10	6 BIT SOCKET HEX BALL 1/2", 5, 6, 7, 8, 9, 10MM
83410006...08	2 BIT SOCKET HEX 1/2", 100MML 6, 8MM
83414010	1 BIT SOCKET HEX 1/2", 140MML 10MM
83424806	1 BIT SOCKET HEX 1/2", 248MML 6
83606245...60	4 BIT SOCKET TX 1/2", T45, T50, T55, T60MM
83610045	1 BIT SOCKET TX 1/2", 100MML T45
83806208...14	5 BIT SOCKET SPLINE 1/2" M8, M9, M10, M12, M14
83806216T	1 BIT SOCKET SPLINE 1/2", M16-T
83810008...14	4 BIT SOCKET SPLINE 1/2" 100MML M8, M10, M12, M14
83910009	1 BIT SOCKET RIBE 1/2", 100MML M9
24934	1 SOCKET 3/4", 12 PT. 34MM
87810518	1 BIT SOCKET IMPACT SPLINE 3/4", M18

04

310501

COMBINATION SET 1/2", SFS 105-PCS

ART. NO.	CONTENTS
102501	25 BIT SET 1/4", 25-PCS
23610...24	9 SOCKET 1/2" TX E10, E11, E12, E14, E16, E18, E20, E22, E24
7273380	1 SWIVEL GRIP HANDLE 1/2" 380MML
83406205...19	10 BIT SOCKET HEX 1/2", 5, 6, 7, 8, 9, 10, 12, 14, 17, 19MM
83410005...14	7 BIT SOCKET HEX 1/2", 100MML 5, 6, 7, 8, 10, 12, 14
83414010	1 BIT SOCKET HEX 1/2", 140MML 10MM
83424806	1 BIT SOCKET HEX 1/2", 248MML 6MM
83606225...70	9 BIT SOCKET TX 1/2", T25, T27, T30, T40, T45, T50, T55, T60, T70
83610025...70	9 BIT SOCKET TX 1/2", 100MML T25, T27, T30, T40, T45, T50, T55, T60, T70
83614070	1 TX BIT SOCKET 1/2", 140MML T70
83806205...14	7 BIT SOCKET SPLINE 1/2", M5, M6, M8, M9, M10, M12, M14
83806216T	1 BIT SOCKET SPLINE 1/2", M16-T
83810006...14	5 BIT SOCKET SPLINE 1/2", 100MML M6, M8, M10, M12, M14
86807818	1 IMPACT BIT SOCKET XZN 1/2", 78MML M18
83910009	1 BIT SOCKET RIBE 1/2", 100MML M9
83912011	1 BIT SOCKET RIBE 1/2", 120MML M10-1
83914010	1 BIT SOCKET RIBE 1/2", 140MML M10
83924007...8	2 BIT SOCKET RIBE 1/2", 240MML M7, M8
818026-6...12	5 TWIST SOCKET 1/4", 6, 8, 10, 11, 12MM
818026-13...21	6 TWIST SOCKET 1/2", 13, 14, 15, 17, 19, 21MM

306601

COMBINATION SET 1/2", SFS 66-PCS

ART. NO.	CONTENTS
23510...32	19 FLANK SOCKET 1/2", 6 PT. 10, 11, 12, 13, 14, 15, 16, 17, 18, 19, 20, 21, 22, 24, 26, 27, 28, 30, 32MM
23610...24	9 SOCKET 1/2" TX E10, E11, E12, E14, E16, E18, E20, E22, E24
3310117...19	2 WHEEL SOCKET 1/2", 6PT. 17, 19MM
4160608...2024	4 TX WRENCH E6XE8, E10XE12, E14XE18, E20XE24
7120903	1 RATCHET HANDLE 1/2" 45 TEETH
7133250	1 SLIDING T HANDLE 1/2", 250MML
7143125...250	2 EXTENSION 1/2", 125, 250MML
71531	1 UNIVERSAL JOINT 1/2"
71923	1 ADAPTOR 3/8"(F) X 1/2"(M)
71932	1 ADAPTOR 1/2"(F) X 3/8"(M)
7263050...500	2 WOBBLE EXTENSION 1/2", 50, 500MML
7273380	1 SWIVEL GRIP HANDLE 1/2" 380MML
83406206...19	9 BIT SOCKET HEX 1/2", 6, 7, 8, 9, 10, 12, 14, 17, 19MM
83606220...60	9 BIT SOCKET TX 1/2" T20, T25, T27, T30, T40, T45, T50, T55, T60
83706230...50	4 BIT SOCKET TAMPERPROOF 1/2", TX T30H, T40H, T45H, T50H

313902

BIT SOCKET SET 1/4", 3/8" & 1/2", SFS 139-PCS

ART. NO.	CONTENTS
21505...13	10 FLANK SOCKET 1/4" 6 PT. 5, 5.5, 6, 7, 8, 9, 10, 11, 12, 13MM
2155005...13	10 FLANK DEEP SOCKET 1/4", 6 PT. 5, 5.5, 6, 7, 8, 9, 10, 11, 12, 13MM
7120901	1 RATCHET HANDLE 1/4" 45 TEETH
7141050...100	2 EXTENSION 1/4" 50, 100MML
71511	1 UNIVERSAL JOINT 1/4"
72401	1 SPINNER 1/4" 150MML
8143703...07	5 BIT SOCKET HEX 1/4", 3, 4, 5, 6, 7MM
8153710...45	8 TAMPER-RESISTANT 1/4" TX PLUS (5 LOBES) 10IPR, 15IPR, 20IPR, 25IPR, 27IPR, 30IPR, 40IPR, 45IPR
8163706...10	5 BIT SOCKET TX 1/4", T6, T7, T8, T9, T10
8173706...10	5 BIT SOCKET TX TAMPERPROOF 1/4", T6H, T7H, T8H, T9H, T10H
22508...19	12 FLANK SOCKET 3/8" 6 PT. 8, 9, 10, 11, 12, 13, 14, 15, 16, 17, 18, 19MM
7120902	1 RATCHET HANDLE 3/8" 45 TEETH
7142075...150	2 EXTENSION 3/8" 75, 150MML
71521	1 UNIVERSAL JOINT 3/8"
7171216...21	3 SPARK PLUG SOCKET 3/8" 16, 18, 21MM
8214802	1 BIT SOCKET PH 3/8", PH.2
8244805...12	8 BIT SOCKET HEX 3/8", 5, 5.5, 6, 7, 8, 9, 10, 12MM
8264815...50	8 BIT SOCKET TX 3/8", T15, T20, T25, T27, T30, T40, T45, T50
8274815...50	8 BIT SOCKET TX TAMPERPROOF 3/8", T15H, T20H, T25H, T27H, T30H, T40H, T45H, T50H
8284804...12	7 BIT SOCKET SPLINE 3/8", M4, M5, M6, M8, M9, M10, M12
23510...32	20 FLANK SOCKET 1/2", 6 PT. 10, 11, 12, 13, 14, 15, 16, 17, 18, 19, 20, 21, 22, 23, 24, 26, 27, 28, 30, 32MM
7120903	1 RATCHET HANDLE 1/2" 45 TEETH
7143125...250	2 EXTENSION 1/2" 125, 250MML
71531	1 UNIVERSAL JOINT 1/2"
71623	1 ADAPTOR FOR EXT. 3/8"(F) X 1/2"(M)
83406210...17	4 BIT SOCKET HEX 1/2", 10, 12, 14, 17MM
83606255...70	3 BIT SOCKET TX 1/2", T55, T60, T70
83706255...70	3 BIT SOCKET TAMPERPROOF 1/2", TX T55H, T60H, T70H
83806210...16	4 BIT SOCKET SPLINE 1/2", M10, M12, M14, M16
83806216T	1 BIT SOCKET SPLINE 1/2", M16-T

309302

SOCKET SET 1/4" 3/8" 1/2", SFS 93-PCS

ART. NO.	CONTENTS
21505...13	9 FLANK SOCKET 1/4" 6 PT. 5, 6, 7, 8, 9, 10, 11, 12, 13MM
2155005...13	9 FLANK DEEP SOCKET 1/4", 6 PT. 5, 6, 7, 8, 9, 10, 11, 12, 13MM
22514...21	7 FLANK SOCKET 3/8" 6 PT. 14, 15, 16, 17, 18, 19, 21MM
2256314...21	7 FLANK DEEP SOCKET 3/8" 6 PT. 14, 15, 16, 17, 18, 19, 21MM
23522...32	8 FLANK SOCKET 1/2" 6 PT. 22, 23, 24, 26, 27, 28, 30, 32MM
2357722...32	8 FLANK DEEP SOCKET 1/2", 6 PT. 22, 23, 24, 26, 27, 28, 30, 32MM
8153715...30	4 TAMPER-RESISTANT 1/4" TX PLUS (5 LOBES) 15IPR, 20IPR, 25IPR, 30IPR
8264808...45	9 BIT SOCKET TX 3/8", T8, T10, T15, T20, T25, T27, T30, T40, T45
83406210...19	5 BIT SOCKET HEX 1/2", 10, 12, 14, 17, 19MM
601008	10 HEX BALL EXTRA LONG KEY SET 10-PCS, 1.27, 1.5, 2, 2.5, 3, 4, 5, 6, 8, 10MM
7110201	1 ROTOR RATCHET 1/4", 72 TEETH
7110301	1 DISC RATCHET 1/4", 72 TEETH
7141050...150	3 EXTENSION 1/4" 50, 100, 150MML
7110202	1 ROTOR RATCHET 3/8", 72 TEETH
7110302	1 DISC RATCHET 3/8", 72 TEETH
7142044...250	4 EXTENSION 3/8" 44, 75, 150, 250MML
71522	1 UNIVERSAL BALL JOINT 3/8"
71632	1 ADAPTOR FOR EXTENSION 1/2"(F) X 3/8"(M)
7110203	1 ROTOR RATCHET 1/2", 72 TEETH
7143125...250	2 EXTENSION 1/2" 125, 250MML
71532	1 UNIVERSAL BALL JOINT 1/2"

303101

IMPACT WRENCH & SOCKET SET 1/2", SFS 31-PCS

ART. NO.	CONTENTS
4240201	1 SUPER DUTY IMPACT WRENCH 1/2"
4240202	1 SUPER DUTY AIR RATCHET WRENCH 1/2"
4240203	1 SUPER DUTY AIR DIE GRINDER
33510...24	11 IMPACT SOCKET 1/2" 6PT. 10, 11, 12, 13, 14, 16, 17, 19, 21, 22, 24MM
3358510...21	7 IMPACT SOCKET 1/2" 6PT. DEEP 10, 11, 13, 14, 17, 19, 21MM
3310117...21	3 WHEEL SOCKET 1/2" 17, 19, 21
7343075...250	3 IMPACT EXTENSION 1/2", 75, 125, 250MML (BALL)
73531	1 IMPACT UNIVERSAL JOINT (BALL) 1/2"
73623	1 IMPACT ADAPTOR 3/8"(F)X1/2"(M) BALL
73632	1 IMPACT ADAPTOR 1/2"(F)X3/8"(M) BALL
73634	1 IMPACT ADAPTOR 1/2"(F)X3/4"(M) BALL

311101



BIT SOCKET SET 1/4", 3/8" & 1/2", SFS 111-PCS

ART. NO.	CONTENTS
21504...13	10 FLANK SOCKET 1/4", 6 PT. 4, 5, 6, 7, 8, 9, 10, 11, 12, 13MM
7120901	1 RATCHET HANDLE 1/4" 45 TEETH
7110301	1 DISC RATCHET 1/4", 72 TEETH
71511	1 UNIVERSAL JOINT 1/4"
7141050...100	2 EXTENSION 1/4" 50, 100MML
71921	1 ADAPTOR 3/8"(F) X 1/4"(M)
8113702	1 BIT SOCKET PH 1/4", PH.2
81337055	1 BIT SOCKET SLOTTED 1/4", 5.5MM
8143703...7	5 BIT SOCKET HEX 1/4", 3, 4, 5, 6, 7MM
8153710...40	7 TAMPER-RESISTANT 1/4", TX PLUS (5 LOBES) 10IPR, 15IPR, 20IPR, 25IPR, 27IPR, 30IPR, 40IPR
8163710...40	7 BIT SOCKET TX 1/4", T10, T15, T20, T25, T27, T30, T40
8173710...40	7 BIT SOCKET TX TAMPERPROOF 1/4" T10H, T15H, T20H, T25H, T27H, T30H, T40H
22508...19	12 FLANK SOCKET 3/8", 6 PT. 8, 9, 10, 11, 12, 13, 14, 15, 16, 17, 18, 19MM
2256308...19	12 FLANK SOCKET 3/8", 6 PT. DEEP 8, 9, 10, 11, 12, 13, 14, 15, 16, 17, 18, 19MM
7120902	1 RATCHET HANDLE 3/8" 45 TEETH
7110302	1 DISC RATCHET 3/8", 72 TEETH
71521	1 UNIVERSAL JOINT 3/8"
7142075...150	2 EXTENSION 3/8" 75, 150MML
71632	1 ADAPTOR FOR EXTENSION 1/2"(F) X 3/8"(M)
7172214	1 SPARK PLUG CLIP SOCKET 12-PT. 3/8" 14MM
7171216...18	3 SPARK PLUG SOCKET 3/8" 16, 18, 21MM
7176208...16	6 GLOW PLUG SOCKET 3/8", 8, 9, 10, 12, 14, 16MM
23510...32	19 FLANK SOCKET 1/2", 6 PT. 10, 11, 12, 13, 14, 15, 16, 17, 18, 19, 20, 21, 22, 24, 26, 27, 28, 30, 32MM
7120903	1 RATCHET HANDLE 1/2" 45 TEETH
71531	1 UNIVERSAL JOINT 1/2"
7133250	1 SLIDING T HANDLE 1/2"
7143125...250	2 EXTENSION 1/2" 125, 250MML
71623	1 ADAPTOR FOR EXTENSION 3/8"(F) X 1/2"(M)
4476004	1 GLOW PLUG PLIERS BENT 240MML
4476005	1 SPARK PLUG PLIERS 290MML

307302



IMPACT SOCKET SET 3/8" & 1/2", SFS 73-PCS

ART. NO.	CONTENTS
32508...19	10 IMPACT SOCKET 3/8", 6PT. 8, 10, 11, 12, 13, 14, 15, 16, 17, 19MM
3256308...19	9 IMPACT SOCKET 3/8", 6PT. DEEP 8, 10, 11, 12, 13, 14, 16, 17, 19MM
7342075	1 IMPACT EXTENSION 3/8" 75MML
73521	1 IMPACT UNIVERSAL JOINT 3/8"
73621	1 IMPACT ADAPTOR 3/8"(F) X 1/4"(M)
73623	1 IMPACT ADAPTOR 3/8"(F) X 1/2"(M)
73721	1 BIT HOLDER 3/8"(F) X 1/4"(F)
33508...32	23 IMPACT SOCKET 1/2", 6PT. 8, 10, 11, 12, 13, 14, 15, 16, 17, 18, 19, 20, 21, 22, 23, 24, 26, 27, 28, 29, 30, 32MM
3358510...32	20 IMPACT SOCKET 1/2", 6PT. DEEP 10, 11, 12, 13, 14, 15, 16, 17, 18, 19, 20, 21, 22, 23, 24, 27, 28, 29, 30, 32MM
7343075...250	2 IMPACT EXTENSION 1/2" 75, 250MML
7343125	1 IMPACT EXTENSION 1/2" 125MML
73531	1 IMPACT UNIVERSAL JOINT 1/2"
73632	1 IMPACT ADAPTOR 1/2"(F) X 3/8"(M)
73634	1 IMPACT ADAPTOR 1/2"(F) X 3/4"(M)

403201



SOCKET SET 3/4", METRIC & SAE SFS 32-PCS

ART. NO.	CONTENTS
24919...50	14 SOCKET 3/4", 12 PT. 19, 21, 22, 24, 27, 30, 32, 33, 34, 36, 38, 41, 46, 50MM
24822...47	14 SOCKET 3/4", 12 PT. 7/8", 15/16", 1", 1.1/16", 1.1/8", 1.3/16", 1.1/4", 1.5/16", 1.3/8", 1.7/16", 1.1/2", 1.5/8", 1.3/4", 1.7/8"
7120704	1 RATCHET HANDLE 3/4" 60 TEETH
7134450	1 SLIDING T HANDLE 3/4"
7234500	1 SWIVEL HANDLE 3/4" 500MML
7184400	1 LOCK-IN 3/4" EXTENSION 400MML

403301



IMPACT SOCKET SET 3/4", SFS 33-PCS

ART. NO.	CONTENTS
34519...46	15 IMPACT SOCKET 3/4", 6PT. 19, 21, 22, 23, 24, 27, 28, 30, 32, 33, 34, 36, 38, 41, 46MM
3459019...46	14 IMPACT SOCKET 3/4", 6PT. DEEP 90MML 19, 21, 22, 23, 24, 27, 30, 32, 33, 34, 36, 38, 41, 46
73643	1 IMPACT ADAPTOR 3/4"(F) X 1/2"(M)
73645	1 IMPACT ADAPTOR 3/4"(F) X 1"(M) PIN
7344150	1 IMPACT EXTENSION 3/4" 150MML
73541	1 IMPACT UNIVERSAL JOINT 3/4" (90MML) (BALL)

604301



TOOLS KITS SET SFS, 43-PCS

ART. NO.	CONTENTS
46905	1 TRIANGULAR FILE FOR BRAKES 8"
4811254	1 STEEL WIRE BRUSH
4811260	1 BRASS BRUSH
47023	1 BRAKE FLUID TESTER DIGITAL
47817	1 PLASTIC SCRAPER 22MM
3310117...21	3 WHEEL SOCKET 1/2", 6PT. 17, 19, 21MM
4474001	1 WHEEL WEIGHT BALANCE PLIERS 10"
4560201	1 COTTER PIN DRIVER FOR BRAKE 175L (POINT 4)
4560202	1 COTTER PIN DRIVER FOR BRAKE 175L 6 (POINT 3)
47024	1 STAINLESS STEEL VERNIER CALLIPER FOR DISC BRAKES
812006	1 BRAKE PISTON REWINDING CUBE
4081011	1 BRAKE LINE SPANNER 10X11MM
4081213	1 BRAKE LINE SPANNER 12X13MM
4391175	1 MOLE WRENCH 100MML
811003-27...36	3 PCS OIL FILTER CARTRIDGE INSERTS 27, 32, 36
812007	1 OIL FILTER CAP 14PT. 74MM
4450300	1 OIL FILTER PLIERS 12"
302001	18 OIL DRAIN SET 1/2", 20-PCS
300306	3 PENTAGON SOCKET SET 1/2", 3-PCS
83806216T	1 BIT SOCKET SPLINE 1/2", M16-T

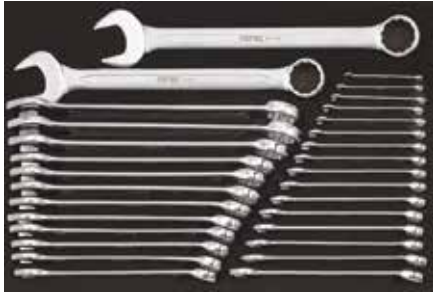
603002

WRENCH SET SFS, 30-PCS

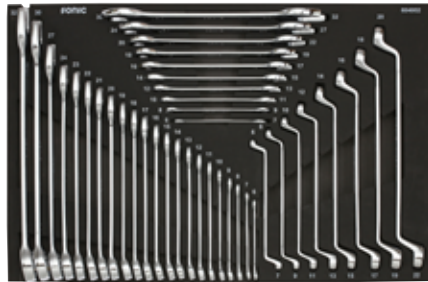
ART. NO.	CONTENTS
41506...38	30 COMBINATION WRENCH 6, 7, 8, 9, 10, 11, 12, 13, 14, 15, 16, 17, 18, 19, 20, 21, 22, 23, 24, 25, 26, 27, 28, 29, 30, 32, 33, 34, 36, 38MM

604002

WRENCH SET SFS, 40-PCS

ART. NO.	CONTENTS
4140607...3032	10 DOUBLE OPEN WRENCH 6X7, 8X9, 10X11, 12X13, 14X15, 16X17, 18X19, 20X22, 24X27, 30X32MM
41506...32	22 COMBINATION WRENCH 6, 7, 8, 9, 10, 11, 12, 13, 14, 15, 16, 17, 18, 19, 20, 21, 22, 23, 24, 27, 30, 32MM
4190607...2022	8 75° OFFSET RING WRENCH 6X7, 8X9, 10X11, 12X13, 14X15, 16X17, 18X19, 20X22MM

603003

WRENCH SET SFS, 30-PCS

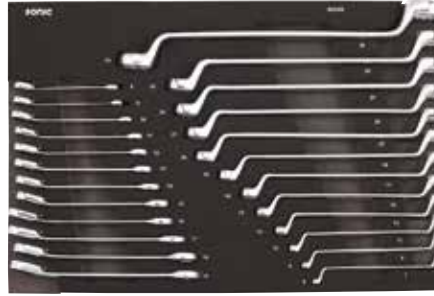
ART. NO.	CONTENTS
4170208...19	12 REVERSIBLE RATCHETING WRENCH 12PT. 8, 9, 10, 11, 12, 13, 14, 15, 16, 17, 18, 19MM
4120607...1819	7 HINGED SOCKET WRENCH 6X7, 8X9, 10X11, 12X13, 14X15, 16X17, 18X19MM
4110810...2427	7 FLARE NUT WRENCH 8X10, 11X13, 12X14, 16X18, 17X19, 19X22, 24X27MM
4160608...2024	4 STAR WRENCH E6XE8, E10XE12, E14XE18, E20XE24

602406

WRENCH SET SFS, 24-PCS

ART. NO.	CONTENTS
4170208...19	12 REVERSIBLE RATCHETING WRENCH 12PT. 8, 9, 10, 11, 12, 13, 14, 15, 16, 17, 18, 19MM
4190607...3436	12 75° OFFSET RING WRENCH 6X7, 8X9, 10X11, 12X13, 14X15, 16X17, 18X19, 20X22, 21X23, 24X27, 25X28, 34X36MM

603701

WRENCH SET SFS, 37-PCS

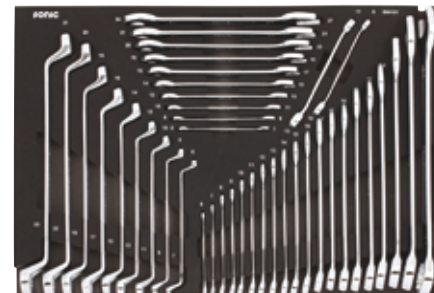
ART. NO.	CONTENTS
41506...22	17 COMBINATION WRENCH 6, 7, 8, 9, 10, 11, 12, 13, 14, 15, 16, 17, 18, 19, 20, 21, 22MM
4140607...3032	10 DOUBLE OPEN WRENCH 6X7, 8X9, 10X11, 12X13, 14X15, 16X17, 18X19, 20X22, 24X27, 30X32MM
4190607...2022	8 75° OFFSET RING WRENCH 6X7, 8X9, 10X11, 12X13, 14X15, 16X17, 18X19, 20X22MM
4200113	1 INJECTION PUMP WRENCH 13MM
40811	1 FLEXIBLE FLARE NUT WRENCH 11MM

604101

WRENCH SET SFS, 41-PCS

ART. NO.	CONTENTS
4110810...1113	2 FLARE NUT WRENCH 8X10, 11X13MM
4140607...2427	10 DOUBLE OPEN WRENCH 6X7, 8X9, 10X11, 12X13, 14X15, 16X17, 18X19, 20X22, 21X23, 24X27MM
41506...32	20 COMBINATION WRENCH 6, 7, 8, 9, 10, 11, 12, 13, 14, 15, 16, 17, 18, 19, 21, 22, 24, 27, 30, 32MM
4190607...2123	9 75° OFFSET RING WRENCH 6X7, 8X9, 10X11, 12X13, 14X15, 16X17, 18X19, 20X22, 21X23MM

604601

WRENCH SET SFS, 46-PCS

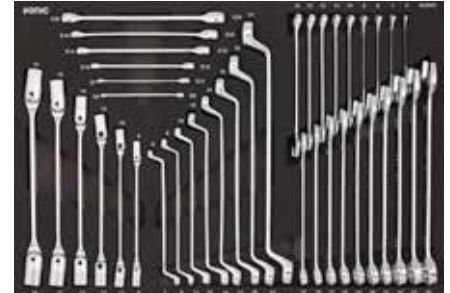
ART. NO.	CONTENTS
4110810...1719	5 FLARE NUT WRENCH 8X10, 11X13, 12X14, 16X18, 17X19MM
4140607...3436	12 DOUBLE OPEN WRENCH 6X7, 8X9, 10X11, 12X13, 14X15, 16X17, 18X19, 21X23, 22X24, 24X27, 30X32, 34X36MM
41506...27	18 COMBINATION WRENCH 6, 7, 8, 9, 10, 11, 12, 13, 14, 15, 16, 17, 18, 19, 21, 22, 24, 27MM
4160608...2024	4 STAR BOX WRENCH E6XE8, E10XE12, E14XE18, E20XE24
4200607...1819	7 FLAT DOUBLE RING WRENCH 6X7, 8X9, 10X11, 12X13, 14X15, 16X17, 18X19MM

603903

WRENCH SET SFS, 39-PCS

ART. NO.	CONTENTS
41506...24	19 COMBINATION WRENCH 6, 7, 8, 9, 10, 11, 12, 13, 14, 15, 16, 17, 18, 19, 20, 21, 22, 23, 24MM
4190607...2123	8 75° OFFSET RING WRENCH 6X7, 8X9, 10X11, 12X13, 14X15, 16X17, 18X19, 21X23MM
4120809...18X19	6 HINGED SOCKET WRENCH 8X9, 10X11, 12X13, 14X15, 16X17, 18X19MM
4160608...2024	6 STAR WRENCH E6XE8, E7XE11, E10XE12, E14XE18, E16XE22, E20XE24

604702

WRENCH SET SFS, 47-PCS

ART. NO.	CONTENTS
4110810...3032	8 FLARE NUT WRENCH 8X10, 11X13, 12X14, 16X18, 17X19, 19X22, 24X27, 30X32MM
4120607...1819	7 HINGED SOCKET WRENCH 6X7, 8X9, 10X11, 12X13, 14X15, 16X17, 18X19MM
4170208...19	12 REVERSIBLE RATCHETING WRENCH 12PT. 8, 9, 10, 11, 12, 13, 14, 15, 16, 17, 18, 19MM
4200607...1819	7 FLAT DOUBLE RING WRENCH 6X7, 8X9, 10X11, 12X13, 14X15, 16X17, 18X19MM
4211012...1417	3 HALF-MOON WRENCH 10X12, 11X13, 14X17MM
42608...17	10 STUBBY COMBINATION WRENCH 8, 9, 10, 11, 12, 13, 14, 15, 16, 17MM

604901



WRENCH SET SFS 49-PCS

ART. NO.	CONTENTS
41506...24	19 COMBINATION WRENCH 6, 7, 8, 9, 10, 11, 12, 13, 14, 15, 16, 17, 18, 19, 20, 21, 22, 23, 24MM
4120809...1819	6 HINGED SOCKET WRENCH 8X9, 10X11, 12X13, 14X15, 16X17, 18X19MM
4160608...2024	6 STAR WRENCH E6XE8, E7XE11, E10XE12, E14XE18, E16XE22, E20XE24
4170208...19	12PT. REVERSIBLE GEAR WRENCH 8, 9, 10, 11, 12, 13, 14, 15, 16, 17, 18, 19MM
4110810...1922	6 FLARE NUT WRENCH 8X10, 11X13, 12X14, 16X18, 17X19, 19X22MM

601404



PLIERS, CHISEL AND HAMMER SET SFS, 14-PCS

ART. NO.	CONTENTS
4311175	1 COMBINATION PLIERS 7"
4321200	1 LONG NOSE PLIERS 8"
4341175	1 DIAGONAL PLIERS 7"
4351250	1 WATERPUMP PLIERS 10"
45118190...24220	2 GRIP CHISEL 190MML 18, 220MML 24
4527190	1 GRIP CAPE CHISEL 190MML 7"
4534180...5200	2 GRIP PIN PUNCH 180MML 4", 200MML 5"
4552185	1 GRIP TAPER PUNCH 185MML 2"
4611400	1 MACHINIST HAMMER 400GR. FIBRE HANDLE TPR COVER
46806	1 UTILITY KNIFE (INCL. 10 BLADES)
47013	1 MEASURING TAPE 5 METER
4820110	1 MAGNET FLEXIBLE

601506



PLIERS AND HAMMER SET 9 SFS, 15-PCS

ART. NO.	CONTENTS
4311175	1 COMBINATION PLIERS 7"
4321200	1 LONG NOSE PLIERS 8"
4331200	1 BENT LONG NOSE PLIERS 8"
4341175	1 DIAGONAL PLIERS 7"
4351250	1 WATERPUMP PLIERS 10"
4380250	1 LOCKING PLIERS 10"
43611	1 SNAP RING PLIERS (STRAIGHT-OPEN)
43612	1 SNAP RING PLIERS (STRAIGHT-CLOSE)
43613	1 SNAP RING PLIERS (BENT-OPEN)
43614	1 SNAP RING PLIERS (BENT-CLOSE)
4611400	1 MACHINIST HAMMER 400GR. FIBRE HANDLE TPR COVER
4631000	1 STONING HAMMER 1000 GR FIBRE HANDLE TPR COVER
45118190...24220	2 GRIP CHISEL 190MML 18, 220MML 24
47013	1 MEASURING TAPE 5 METER

602302



CHISEL, HAMMER, PLIERS & FILE SET SFS, 23-PCS

ART. NO.	CONTENTS
4311175	1 COMBINATION PLIERS 7"
4321200	1 LONG NOSE PLIERS 8"
4331200	1 BENT LONG NOSE PLIERS 8"
4341175	1 DIAGONAL PLIERS 7"
4351250	1 WATERPUMP PLIERS 10"
4380250	1 LOCKING PLIERS 10"
45118190...24220	2 GRIP CHISEL 190MML 18, 220MML 24
4533150...6210	4 GRIP PIN PUNCH 150MML 3, 180MML 4, 200MML 5, 210MML 6
4552185...4185	3 GRIP TAPER PUNCH 185MML 2, 3, 4
4611400	1 MACHINIST HAMMER 400 GR FIBRE HANDLE TPR COVER
4631000	1 STONING HAMMER 1000 GR FIBRE HANDLE TPR COVER
47013	1 5M MEASURING TAPE
46806	1 UTILITY KNIFE (INCL. 10 BLADES)
46911	1 8" FLAT FILE
46912	1 8" HALF ROUND FILE
46913	1 8" ROUND FILE
46914	1 8" TRIANGULAR FILE

601707



PLIERS, CHISEL AND HAMMER SET 5 SFS, 12-PCS

ART. NO.	CONTENTS
4311175	1 LONG NOSE PLIERS 8"
4321200	1 BENT LONG NOSE PLIERS 8"
4331200	1 COMBINATION PLIERS 7"
4341175	1 DIAGONAL PLIERS 7"
4351250	1 WATERPUMP PLIERS 10"
4380250	1 LOCKING PLIERS 10"
45118190...24220	2 GRIP CHISEL 190MML 18, 220MML 24
4611400	1 MACHINIST HAMMER 400 GR FIBRE HANDLE TPR COVER
4631000	1 STONING HAMMER 1000 GR FIBRE HANDLE TPR COVER
46911	1 FLAT FILE 8"
46912	1 HALF ROUND FILE 8"
46913	1 ROUND FILE 8"
46914	1 TRIANGULAR FILE 8"
47013	1 MEASURING TAPE 5 METER
4820110	1 MAGNET FLEXIBLE 10 LBS
4811254	1 STEEL WIRE BRUSH

602209



CHISEL, HAMMER & PLIERS SET SFS, 22-PCS

ART. NO.	CONTENTS
4311175	1 COMBINATION PLIERS 7"
4321200	1 LONG NOSE PLIERS 8"
4331200	1 BENT LONG NOSE PLIERS 8"
4341175	1 DIAGONAL PLIERS 7"
4351250	1 WATERPUMP PLIERS 10"
43611	1 SNAP RING PLIERS (STRAIGHT-OPEN)
43612	1 SNAP RING PLIERS (STRAIGHT-CLOSE)
43613	1 SNAP RING PLIERS (BENT-OPEN)
43614	1 SNAP RING PLIERS (BENT-CLOSE)
4611400	1 MACHINIST HAMMER 400GR. FIBRE HANDLE TPR COVER
4631000	1 STONING HAMMER 1000 GR FIBRE HANDLE TPR COVER
4380250	1 LOCKING PLIERS 10"
45118190...24220	2 GRIP CHISEL 190MML 18, 220MML 24
4533150...6210	4 GRIP PIN PUNCH 150MML 3", 180MML 4", 200MML 5", 210MML 6"
4552185...4185	3 GRIP TAPER PUNCH 185MML 2", 3", 4"
47013	1 MEASURING TAPE 5 METER

602304



PLIER SET SFS, 23-PCS

ART. NO.	CONTENTS
4311175	1 COMBINATION PLIERS 7"
4321200	1 LONG NOSE PLIERS 8"
4341175	1 DIAGONAL PLIERS 7"
4351250	1 WATERPUMP PLIERS 10"
4380250	1 LOCKING PLIERS 10"
43613	1 SNAP RING PLIERS (BENT-OPEN)
447101	1 AUTOMATIC WIRE STRIPPER 0.5-4MM
4471250	1 WIRE STRIPPER 10"
45116170...18190	2 GRIP CHISEL 170MML 16, 190MML 18
4527190	1 GRIP CAPE CHISEL 190MML 7
4532140...8220	6 GRIP PIN PUNCH 140MML 2, 150MML 3, 180MML 4, 200MML 5, 210MML 6, 220MML 8
4564185	1 GRIP CENTER PUNCH 185MML 4
4611400	1 MACHINIST HAMMER 400 GR FIBRE HANDLE TPR COVER
4620400	1 SAND FILLED HAMMER 400GR
47903	1 SCRAPER
4811254	1 STEEL BRUSH
4821301	1 WEDGE UNIVERSAL 190X30MM

601802



PLIERS SET SFS, 18-PCS

ART. NO.	CONTENTS
4311175	1 COMBINATION PLIERS 7"
4321200	1 LONG NOSE PLIERS 8"
4331200	1 BENT LONG NOSE PLIERS 8"
4341175	1 DIAGONAL PLIERS 7"
4351250	1 WATERPUMP PLIERS 10"
43611	1 SNAP RING PLIERS (STRAIGHT-OPEN)
43612	1 SNAP RING PLIERS (STRAIGHT-CLOSE)
43613	1 SNAP RING PLIERS (BENT-OPEN)
43614	1 SNAP RING PLIERS (BENT-CLOSE)
4380250	1 LOCKING PLIERS 10"
46807	1 UTILITY KNIFE ZINC ALLOY (INCL. 6PC BLADES)
46911	1 FLAT FILE 8"
46912	1 HALF ROUND FILE 8"
46913	1 ROUND FILE 8"
46914	1 TRIANGULAR FILE 8"
47002	1 FEELER GAUGE 26-PCS
47003	1 VERNIER CALIPER
47013	1 MEASURING TAPE 5 METER

602103



CHISEL & HAMMER SET SFS, 21-PCS

ART. NO.	CONTENTS
45118190	1 GRIP CHISEL 190MML 18
45124220	1 GRIP CHISEL 190MML 24
4527190	1 GRIP CAPE CHISEL 190MML 7
4533150	1 GRIP PIN PUNCH 150MML 3
4534180	1 GRIP PIN PUNCH 180MML 4
4535200	1 GRIP PIN PUNCH 200MML 5
4536210	1 GRIP PIN PUNCH 210MML 6
4538220	1 GRIP PIN PUNCH 220MML 8
4552185	1 GRIP TAPER PUNCH 185MML 2
4553185	1 GRIP TAPER PUNCH 185MML 3
4554185	1 GRIP TAPER PUNCH 185MML 4
4564185	1 GRIP CENTER PUNCH 185MML 4
4611400	1 MACHINIST HAMMER 400 GR FIBRE HANDLE TPR COVER
4620400	1 SAND FILLED HAMMER 400GR
4631000	1 STONING HAMMER 1000 GR FIBRE HANDLE TPR COVER
47903	1 SCRAPER
4820110	1 MAGNET PICKUP 10LBS.
4811254	1 STEEL BRUSH
4821301	1 WEDGE UNIVERSAL 190X30MM
48212380	1 PRY BAR 380MM
4820207	1 FLEXIBLE MAGNET PICKUP 500G-400L

601207



PLIERS SET SFS, 12-PCS

ART. NO.	CONTENTS
4311175	1 COMBINATION PLIERS 7"
4321200	1 LONG NOSE PLIERS 8"
4331200	1 BENT LONG NOSE PLIERS 8"
4341175	1 DIAGONAL PLIERS 7"
4351250	1 WATERPUMP PLIERS 10"
43611	1 SNAP RING PLIERS (STRAIGHT-OPEN)
43612	1 SNAP RING PLIERS (STRAIGHT-CLOSE)
43613	1 SNAP RING PLIERS (BENT-OPEN)
43614	1 SNAP RING PLIERS (BENT-CLOSE)
4380250	1 LOCKING PLIERS 10"
4381225	1 LONG NOSE LOCKING PLIER 225MML
4382125	1 CURVED JAW LOCKING PLIER 125MML

603601



PLIERS SET SFS, 36-PCS

ART. NO.	CONTENTS
4311175	1 COMBINATION PLIERS 7"
4321200	1 LONG NOSE PLIERS 8"
4341175	1 DIAGONAL PLIERS 7"
4351250	1 WATERPUMP PLIERS 10"
43611	1 SNAP RING PLIERS (STRAIGHT-OPEN)
43612	1 SNAP RING PLIERS (STRAIGHT-CLOSE)
43613	1 SNAP RING PLIERS (BENT-OPEN)
43614	1 SNAP RING PLIERS (BENT-CLOSE)
4380250	1 LOCKING PLIERS 10"
46807	1 UTILITY KNIFE (INCL. 13 BLADES)
4820110	1 MAGNET PICKUP 10LBS.
4821105	1 FLASH PEN
4820207	1 FLEXIBLE MAGNET PICKUP 500G-400L
600902	9 TX WRENCH, EXTRA LONG KEY SET 9-PCS
601006	10 HEX BALL LONG KEY SET 10-PCS
1860106...09	4 KEY WRENCH TX, EXTRA LONG T6, T7, T8, T9

601601



CHISEL & HAMMER SET SFS, 16-PCS

ART. NO.	CONTENTS
45110141	1 GRIP CHISEL 140MML 10
45112160	1 GRIP CHISEL 160MML 12
45118190	1 GRIP CHISEL 190MML 18
45124220	1 GRIP CHISEL 220MML 24
4527190	1 GRIP CAPE CHISEL 190MML 7
4533150	1 GRIP PIN PUNCH 150MML 3
4534180	1 GRIP PIN PUNCH 180MML 4
4535200	1 GRIP PIN PUNCH 200MML 5
4536210	1 GRIP PIN PUNCH 210MML 6
4552185	1 GRIP TAPER PUNCH 185MML 2
4553185	1 GRIP TAPER PUNCH 185MML 3
4554185	1 GRIP TAPER PUNCH 185MML 4
4564185	1 GRIP CENTER PUNCH 185MML 4
4611400	1 MACHINIST HAMMER 400 GR FIBRE HANDLE TPR COVER
4620400	1 SAND FILLED HAMMER 400GR
4631000	1 STONING HAMMER 1000 GR FIBRE HANDLE TPR COVER

601706



CHISEL & HAMMER SET SFS, 15-PCS

ART. NO.	CONTENTS
45118190	1 GRIP CHISEL 190MML 18
45124220	1 GRIP CHISEL 220MML 24
4527190	1 GRIP CAPE CHISEL 190MML 7
4533150	1 GRIP PIN PUNCH 150MML 3
4534180	1 GRIP PIN PUNCH 180MML 4
4535200	1 GRIP PIN PUNCH 200MML 5
4536210	1 GRIP PIN PUNCH 210MML 6
4538220	1 GRIP PIN PUNCH 220MML 8
4564185	1 GRIP CENTER PUNCH 185MML
4611400	1 MACHINIST HAMMER 400 GR FIBRE HANDLE TPR COVER
4620400	1 SAND FILLED HAMMER 400GR
47013	1 MEASURING TAPE 5 METER
47019	1 VOLT CIRCUIT TESTER
47903	1 SCRAPER
4811254	1 STEEL WIRE BRUSH
4821301	1 WEDGE UNIVERSAL 190X30MM
48212380	1 PRY BAR 380 MM

602105



SOCKET SCREWDRIVER, HEX & GRIP KEY SET SFS, 21-PCS

ART. NO.	CONTENTS
12425004...13	10 HEX NUT DRIVER 4, 5, 5.5, 6, 8, 9, 10, 11, 12, 13MM
1960208...50	10 T-HANDLE TX KEY WRENCH T8, T10, T15, T20, T25, T27, T30, T40, T45, T50
47537	1 FLEXIBLE SOCKET SCREWDRIVER, HEX 7MM

309301



SOCKET SET 12PT. SFS 1/4" 3/8" 1/2", 93-PCS

ART. NO.	CONTENTS
21905...13	9 SOCKET 1/4", 12 PT. 3/16", 7/32", 1/4", 9/32", 5/16", 11/32", 3/8", 7/16", 1/2"
2195005...12	9 SOCKET 1/4", 12 PT. DEEP 3/16", 7/32", 1/4", 9/32", 5/16", 11/32", 3/8", 7/16", 1/2"
22910...19	7 SOCKET 3/8", 12 PT. 3/8", 7/16", 1/2", 9/16", 5/8", 11/16", 3/4"
2296310...19	7 SOCKET 3/8", 12 PT. DEEP 3/8", 7/16", 1/2", 9/16", 5/8", 11/16", 3/4"
23921...32	8 SOCKET 1/2", 12 PT. 13/16", 7/8", 15/16", 1", 1.1/16", 1.1/8", 1.3/16", 1.1/4"
2397721...32	8 SOCKET 1/2", 12 PT. DEEP 13/16", 7/8", 15/16", 1", 1.1/16", 1.1/8", 1.3/16", 1.1/4"
81413703...06	4 BIT SOCKET HEX 1/4", 1/8", 5/32", 3/16", 7/32"
82414803...13	9 BIT SOCKET HEX 3/8", 1/8", 5/32", 3/16", 7/32", 1/4", 5/16", 3/8", 7/16", 1/2"
834106210...17	5 BIT SOCKET HEX 1/2", 3/8", 7/16", 1/2", 9/16", 5/8"
601003	10 HEXAGON KEY WRENCH, EXTRA LONG SET 10-PCS 1/16", 5/64", 3/32", 1/8", 5/32", 3/16", 7/32", 1/4", 5/16", 3/8"
7110201	1 ROTOR RATCHET 1/4", 72 TEETH
7110301	1 DISC RATCHET 1/4", 72 TEETH
7141050...150	3 EXTENSION 1/4" 50, 100, 150MML
7110202	1 ROTOR RATCHET 3/8", 72 TEETH
7110302	1 DISC RATCHET 3/8", 72 TEETH
7142044...250	4 EXTENSION 3/8" 44MML, 75MML, 150MML, 250MML
71522	1 UNIVERSAL BALL JOINT 3/8"
71632	1 ADAPTOR FOR EXT. 1/2"(F) X 3/8"(M)
7110203	1 ROTOR RATCHET 1/2", 72 TEETH
7143125...250	2 EXTENSION 1/2" 125MML, 250MML
71531	1 UNIVERSAL BALL JOINT 1/2"

600928



9PCS HEX NUT DRIVER SET T HANDLE S

ART. NO.	CONTENTS
14423005	8 HEX NUT DRIVER T HANDLE 5, 6, 7, 8, 9, 10, 11, 12, 13MM

602104



SOCKET SCREWDRIVER, HEX & GRIPS KEY SET SFS, 21-PCS

ART. NO.	CONTENTS
12425008...13	9 HEX NUT DRIVER 4, 5, 5.5, 6, 9, 10, 11, 12, 13MM
1950202...12	10 HEX BALL POINT GRIP KEY 2, 2.5, 3, 4, 5, 6, 7, 8, 10, 12MM
47537...38	2 FLEXIBLE HEX NUT DRIVER 7, 8MM

310001



SOCKET SET 1/4", 3/8" & 1/2", 12 PT. SFS 100-PCS

ART. NO.	CONTENTS
21905...13	9 SOCKET 1/4", 12 PT. 3/16", 7/32", 1/4", 9/32", 5/16", 11/32", 3/8", 7/16", 1/2"
2195005...12	9 SOCKET 1/4", 12 PT. DEEP 3/16", 7/32", 1/4", 9/32", 5/16", 11/32", 3/8", 7/16", 1/2"
22910...21	8 SOCKET 3/8", 12 PT. 3/8", 7/16", 1/2", 9/16", 5/8", 11/16", 3/4", 13/16"
2296310...21	8 SOCKET 3/8", 12 PT. DEEP 3/8", 7/16", 1/2", 9/16", 5/8", 11/16", 3/4", 13/16"
23910...32	15 SOCKET 1/2", 12 PT. 3/8", 7/16", 1/2", 9/16", 5/8", 11/16", 3/4", 13/16", 7/8", 15/16", 1", 1.1/16", 1.1/8", 1.3/16", 1.1/4"
2397710...32	15 SOCKET 1/2", 12 PT. DEEP 3/8", 7/16", 1/2", 9/16", 5/8", 11/16", 3/4", 13/16", 7/8", 15/16", 1", 1.1/16", 1.1/8", 1.3/16", 1.1/4"
81413703...10	7 BIT SOCKET HEX 1/4", 1/8", 5/32", 3/16", 7/32", 1/4", 5/16", 3/8"
82414803...13	9 BIT SOCKET HEX 3/8", 1/8", 5/32", 3/16", 7/32", 1/4", 5/16", 3/8", 7/16", 1/2"
834106205...17	10 BIT SOCKET HEX 1/2", 3/16", 1/4", 9/32", 5/16", 11/32", 3/8", 7/16", 1/2", 9/16", 5/8"
601003	10 HEXAGON KEY WRENCH, EXTRA LONG SET 10-PCS

603101



WRENCH SET SFS, 31-PCS

ART. NO.	CONTENTS
4150206...24	12 COMBINATION WRENCH 1/4", 5/16", 3/8", 7/16", 1/2", 9/16", 5/8", 11/16", 3/4", 13/16", 7/8", 1 5/16"
4220608...2932	8 DOUBLE OPEN WRENCH 1/4"X5/16", 3/8"X7/16", 1/2"X9/16", 5/8"X11/16", 11/16"X3/4", 13/16"X7/8", 15/16"X1", 1.1/8"X1.1/4"
4270608...2425	7 45° OFFSET RING WRENCH 1/4"X5/16", 3/8"X7/16", 1/2"X9/16", 9/16"X5/8", 11/16"X3/4", 13/16"X7/8", 15/16"X1"
4250608...1617	4 FLARE NUT WRENCH 1/4"X5/16", 3/8"X7/16", 1/2"X9/16", 5/8"X11/16"

47612



SFS S15 FOAM SPACER 570X240MM

ART. NO.	CONTENTS
47612	1 SFS S15 FOAM SPACER

603202

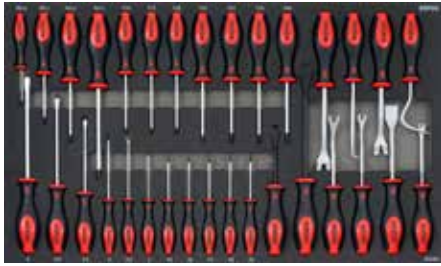

SCREWDRIVER SET SFS JUMBO 32-PCS

ART. NO.	CONTENTS
1310...3	4 SCREWDRIVER PH.0,PH.1,PH.2,PH.3
13303...08	6 SCREWDRIVER, SLOTTED 3, 3.5, 4, 5.5, 6.5, 8MM
13605...40	12 SCREWDRIVER, TX T5, T6, T7, T8, T9, T10, T15, T20, T25, T27, T30, T40
47901...2	2 DOOR UPHOLSTERY PANEL REMOVER SMALL 100MML, 110MML
47903	1 SCRAPER
47904	1 COTTER PIN PULLER
47905	1 RADIATOR HOSE REMOVER
47906	1 TRIM PAD TOOL 1/4" X 115MML
47907	1 TRIM PAD TOOL 5/16" X 115MML
47908	1 DOOR UPHOLSTERY PANEL REMOVER 132MML
4821308...12	2 PRY BAR 200MM 8", 300MM 12"

114602



SCREWDRIVER & 1/4" BIT SOCKET SET SFS JUMBO 146-PCS

ART. NO.	CONTENTS
1310...3	4 SCREWDRIVER, PH.0,PH.1,PH.2,PH.3
1311S	1 SCREWDRIVER, STUBBY PH.1
13303...08	6 SCREWDRIVER, SLOTTED 3, 3.5, 4, 5.5, 6.5, 8MM
133055S	1 SCREWDRIVER, STUBBY SLOTTED 5.5MM
13605...40	12 SCREWDRIVER, TX T5, T6, T7, T8, T9, T10, T15, T20, T25, T27, T30, T40
47903	1 SCRAPER
4821312	1 PRY BAR 300MM 12"
4821105	1 FLASH PEN
21504...13	12 FLANK SOCKET 1/4", 6 PT. 4, 4.5, 5, 5.5, 6, 7, 8, 9, 10, 11, 12, 13MM
2155004...13	12 FLANK DEEP SOCKET 1/4", 6 PT. 4, 4.5, 5, 5.5, 6, 7, 8, 9, 10, 11, 12, 13MM
21604...10	6 SOCKET 1/4", TX E4, E5, E6, E7, E8, E10
2165004...2165010	6 SOCKET 1/4", TX DEEP E4, E5, E6, E7, E8, E10
7110201	1 ROTOR RATCHET 1/4", 72 TEETH
7110301	1 DISC RATCHET 1/4", 45 TEETH
7120901	1 RATCHET HANDLE 1/4" 45 TEETH
7141050...150	3 EXTENSION 1/4" 50, 100, 150MML
7261250	1 WOBBLE EXTENSION 1/4" 250MML
71511	1 UNIVERSAL JOINT 1/4"
71912	1 ADAPTOR 1/4"(F)X3/8"(M)
71921	1 ADAPTOR 3/8"(F)X1/4"(M)
72225	1 MAGNET SOCKET PICK-UP 1/4"
72401	1 SPINNER 1/4" 150MML
8103703...10	9 BIT SOCKET HEX BALL 1/4", 3, 4, 5, 5.5, 6, 7, 8, 9, 10MM
8113700...02	3 BIT SOCKET PH 1/4", PH.0, PH.1, PH.2
8123700...02	3 BIT SOCKET PZ 1/4", PZ.0, PZ.1, PZ.2
81337055...065	2 BIT SOCKET SLOTTED 1/4", 5.5, 6.5MM
8143703...10	9 BIT SOCKET HEX 1/4", 3, 4, 5, 5.5, 6, 7, 8, 9, 10MM
8153708...45	9 TAMPER-RESISTANT 1/4" TX PLUS (5 LOBES) 8IPR, 10IPR, 15IPR, 20IPR, 25IPR, 27IPR, 30IPR, 40IPR, 45IPR
81613710...40	7 BIT SOCKET TX BALL 1/4" T10, T15, T20, T25, T27, T30, T40
8163706...27	9 BIT SOCKET TX 1/4" T6, T7, T8, T9, T10, T15, T20, T25, T27
8173707...27	9 BIT SOCKET TX TAMPERPROOF 1/4" T7H, T8H, T9H, T10H, T15H, T20H, T25H, T27H
8183704...10	5 BIT SOCKET SPLINE 1/4", M4, M5, M6, M8, M10
8193704...10	6 BIT SOCKET RIBE 1/4", M4, M5, M6, M7, M8, M10

216401



SOCKET SET 3/8", SFS JUMBO 164-PCS

ART. NO.	CONTENTS
22506...22	17 FLANK SOCKET 3/8", 6 PT. 6, 7, 8, 9, 10, 11, 12, 13, 14, 15, 16, 17, 18, 19, 20, 21, 22MM
2256306...22	17 FLANK SOCKET 3/8", 6 PT. DEEP 6, 7, 8, 9, 10, 11, 12, 13, 14, 15, 16, 17, 18, 19, 20, 21, 22MM
22606...20	10 SOCKET 3/8", TX E6, E7, E8, E10, E11, E12, E14, E16, E18, E20
2266306...20	10 SOCKET 3/8", TX DEEP E6, E7, E8, E10, E11, E12, E14, E16, E18, E20
7110202	1 ROTOR RATCHET 3/8", 72 TEETH
7120902	1 RATCHET HANDLE 3/8" 45 TEETH
7142044...250	4 EXTENSION 3/8" 44, 75, 150, 250MML
7262044...450	5 WOBBLE EXTENSION 3/8", 44, 150, 200, 300, 450MML
71521	1 UNIVERSAL JOINT 3/8"
7152450	1 T WRENCH UNIVERSAL JOINT 3/8", 450MML
71632	1 ADAPTOR FOR EXT. 1/2"(F)X3/8"(M)
7172214...21	4 SPARK PLUG CLIP SOCKET 12-PT. 3/8" 14, 16, 18, 21
72602	1 SPEEDY T-GRIP 3/8"
7272250	1 SWIVEL GRIP HANDLE 3/8" 250MML
732210100	1 TORQUE WRENCH 3/8" 10-100NM 405L
8214801...03	3 BIT SOCKET PH 3/8", PH.1, PH.2, PH.3
8224801...03	3 BIT SOCKET PZ 3/8", PZ.1, PZ.2, PZ.3
82348055...08	4 BIT SOCKET SLOTTED 3/8", 5.5, 6, 7, 8MM
8244803...12	10 BIT SOCKET HEX 3/8" 3, 4, 5, 5.5, 6, 7, 8, 9, 10, 12MM
8249004...10	8 BIT SOCKET HEX 3/8" 90MML 4, 5, 5.5, 6, 7, 8, 9, 10MM
8264808...60	12 BIT SOCKET TX 3/8" T8, T10, T15, T20, T25, T27, T30, T40, T45, T50, T55, T60
8269010...50	9 BIT SOCKET TX 3/8" 90MML T10, T15, T20, T25, T27, T30, T40, T45, T50
8274808...60	12 BIT SOCKET TX TAMPERPROOF 3/8" T8H, T10H, T15H, T20H, T25H, T27H, T30H, T40H, T45H, T50H, T55H, T60H
8284804...12	7 BIT SOCKET SPLINE 3/8" M4, M5, M6, M8, M9, M10, M12
8289005...12	6 BIT SOCKET SPLINE 3/8" 90MML M5, M6, M8, M9, M10, M12
8294804...12	8 BIT SOCKET RIBE 3/8" M4, M5, M6, M7, M8, M9, M10, M12
8299005...12	7 BIT SOCKET RIBE 3/8" 90MML M5, M6, M7, M8, M9, M10, M12

221201



SOCKET SET 1/4" & 3/8", SFS JUMBO 212-PCS

ART. NO.	CONTENTS
21504...13	12 FLANK SOCKET 1/4", 6 PT. 4, 4.5, 5, 5.5, 6, 7, 8, 9, 10, 11, 12, 13MM
2155004...13	12 FLANK DEEP SOCKET 1/4" 6PT. 4, 4.5, 5, 5.5, 6, 7, 8, 9, 10, 11, 12, 13MM
21604...10	6 SOCKET 1/4", TX E4, E5, E6, E7, E8, E10
2165004...10	6 SOCKET 1/4", TX DEEP E4, E5, E6, E7, E8, E10
8143703...10	7 BIT SOCKET HEX 1/4", 3, 4, 5, 6, 7, 8, 10MM
8113700...02	3 BIT SOCKET PH 1/4", PH.0, PH.1, PH.2
8123700...02	3 BIT SOCKET PZ 1/4", PZ.0, PZ.1, PZ.2
8133704...065	3 BIT SOCKET SLOTTED 1/4", 4, 5.5, 6.5MM
8153710...40	7 TAMPER-RESISTANT 1/4", TX PLUS (5 LOBES) 10IPR, 15IPR, 20IPR, 25IPR, 27IPR, 30IPR, 40IPR
8163708...40	8 BIT SOCKET TX 1/4", T8, T10, T15, T20, T25, T27, T30, T40
8173708...40	8 BIT SOCKET TX TAMPERPROOF 1/4", T8H, T10H, T15H, T20H, T25H, T27H, T30H, T40H
7120901	1 RATCHET HANDLE 1/4" 45 TEETH
7120701	1 RATCHET HANDLE 1/4" 72 TEETH
7110101	1 FLEXIBLE RATCHET 1/4", 45 TEETH
7110301	1 DISC RATCHET 1/4", 72 TEETH
7141050...150	3 EXTENSION 1/4", 50, 100, 150MML
71511	1 UNIVERSAL 1/4" JOINT
71921	1 ADAPTOR 3/8"(F)X1/4"(M)
72225	1 MAGNET SOCKET PICK-UP 1/4"
22506...22	17 FLANK SOCKET 3/8", 6 PT. 6, 7, 8, 9, 10, 11, 12, 13, 14, 15, 16, 17, 18, 19, 20, 21, 22MM
2256306...22	17 FLANK SOCKET 3/8", 6 PT. DEEP 6, 7, 8, 9, 10, 11, 12, 13, 14, 15, 16, 17, 18, 19, 20, 21, 22MM
22604...16	10 SOCKET 3/8" TX E4, E5, E6, E7, E8, E10, E11, E12, E14, E16
2266304...16	10 SOCKET 3/8" TX DEEP E4, E5, E6, E7, E8, E10, E11, E12, E14, E16
8214801...03	3 BIT SOCKET PH 3/8", PH.1, PH.2, PH.3
8224801...03	3 BIT SOCKET PZ 3/8", PZ.1, PZ.2, PZ.3
8234805...07	3 BIT SOCKET SLOTTED 3/8", 5.5, 6, 7MM
8244803...12	10 BIT SOCKET HEX 3/8", 3, 4, 5, 5.5, 6, 7, 8, 9, 10, 12MM
8264808...60	12 BIT SOCKET TX 3/8", T8, T10, T15, T20, T25, T27, T30, T40, T45, T50, T55, T60
8274808...60	12 BIT SOCKET TX TAMPERPROOF 3/8", T8H, T10H, T15H, T20H, T25H, T27H, T30H, T40H, T45H, T50H, T55H, T60H
8284805...12	6 BIT SOCKET SPLINE 3/8" M5, M6, M8, M9, M10, M12
8294804...12	8 BIT SOCKET RIBE 3/8" M4, M5, M6, M7, M8, M9, M10, M12
7120102	1 STUBBY RATCHET 3/8" 45 TEETH
7120902	1 RATCHET HANDLE 3/8" 45 TEETH
7110102	1 FLEXIBLE RATCHET 3/8", 45 TEETH
7110302	1 DISC RATCHET 3/8", 72 TEETH
732210100	1 TORQUE WRENCH 3/8" 10-100NM
7142044...250	4 EXTENSION 3/8", 44, 75, 150, 250MML
71521	1 UNIVERSAL JOINT 3/8"
7152450	1 T WRENCH UNIVERSAL JOINT 3/8", 450MML
71632	1 ADAPTOR FOR EXTENSION 1/2"(F) X 3/8"(M)
7172216...21	3 SPARK PLUG 3/8" CLIP SOCKET 16, 18, 21MM
7232250	1 SWIVEL HANDLE 3/8", 250MML

311801



SOCKET SET 1/2", SFS JUMBO 118-PCS

ART. NO.	CONTENTS
23508...32	22 FLANK SOCKET 1/2", 6 PT. 8, 9, 10, 11, 12, 13, 14, 15, 16, 17, 18, 19, 20, 21, 22, 23, 24, 26, 27, 28, 30, 32MM
2357708...32	22 FLANK SOCKET 1/2", 6 PT. DEEP 8, 9, 10, 11, 12, 13, 14, 15, 16, 17, 18, 19, 20, 21, 22, 23, 24, 26, 27, 28, 30, 32MM
23610...22	8 SOCKET 1/2", TX E10, E11, E12, E14, E16, E18, E20, E22
3310117...21	3 WHEEL SOCKET 1/2", 6PT. 17, 19, 21MM
7120903	1 RATCHET HANDLE 1/2" 45 TEETH
7143125...250	2 EXTENSION 1/2" 125, 250MML
71531	1 UNIVERSAL JOINT 1/2"
71623	1 ADAPTOR FOR EXT. 3/8"(F) X 1/2"(M)
7273380	1 SWIVEL GRIP HANDLE 1/2" 380MML
732320200	1 TORQUE WRENCH 1/2" 20-200NM
83406205...14	8 BIT SOCKET HEX 1/2", 5, 6, 7, 8, 9, 10, 12, 14MM
83410005...14	8 BIT SOCKET HEX 1/2", 100MML 5, 6, 7, 8, 9, 10, 12, 14MM
83606227...70	8 BIT SOCKET TX 1/2", T27, T30, T40, T45, T50, T55, T60, T70
83610027...70	8 BIT SOCKET TX 1/2", 100MML T27, T30, T40, T45, T50, T55, T60, T70
83706227...70	8 BIT SOCKET TAMPERPROOF 1/2", TX T27H, T30H, T40H, T45H, T50H, T55H, T60H, T70H
83806205...14	7 BIT SOCKET SPLINE 1/2", M5, M6, M8, M9, M10, M12, M14
83806216T	1 BIT SOCKET SPLINE 1/2", M16-T
83906207...16	8 BIT SOCKET RIBE 1/2", M7, M8, M9, M10, M12, M13, M14, M16

315601



COMBINATION SET 1/4", 3/8" & 1/2", SFS JUMBO 156-PCS

ART. NO.	CONTENTS
21503...13	13 FLANK SOCKET 1/4", 6 PT. 3, 4, 4.5, 5, 5.5, 6, 7, 8, 9, 10, 11, 12, 13MM
2155005...13	9 FLANK DEEP SOCKET 1/4", 6 PT. 5, 6, 7, 8, 9, 10, 11, 12, 13MM
8143703...10	7 BIT SOCKET HEX 1/4", 3, 4, 5, 6, 7, 8, 10MM
8113701...03	3 BIT SOCKET PH 1/4", PH.1, PH.2, PH.3
8123701...03	3 BIT SOCKET PZ 1/4", PZ.1, PZ.2, PZ.3
8133704...065	3 BIT SOCKET SLOTTED 1/4", 4, 5.5, 6.5MM
8163708...40	8 BIT SOCKET TX 1/4" T8, T10, T15, T20, T25, T27, T30, T40
7120901	1 RATCHET HANDLE 1/4" 45 TEETH
7141050...100	2 EXTENSION 1/4" 50, 100MML
71511	1 UNIVERSAL JOINT 1/4"
72401	1 SPINNER 1/4" 150MML
22506...22	17 FLANK SOCKET 3/8" 6 PT. 6, 7, 8, 9, 10, 11, 12, 13, 14, 15, 16, 17, 18, 19, 20, 21, 22MM
22604...14	9 SOCKET 3/8", TX E4, E5, E6, E7, E8, E10, E11, E12, E14
8244803...10	9 BIT SOCKET HEX 3/8", 3, 4, 5, 5.5, 6, 7, 8, 9, 10MM
8264815...55	9 BIT SOCKET TX 3/8", T15, T20, T25, T27, T30, T40, T45, T50, T55
8274815...55	9 BIT SOCKET TX TAMPERPROOF 3/8", T15H, T20H, T25H, T27H, T30H, T40H, T45H, T50H, T55H
7120902	1 RATCHET HANDLE 3/8" 45 TEETH
7171216...21	3 SPARK PLUG SOCKET 3/8" 16, 18, 21MM
7142075...250	3 EXTENSION 3/8" 75, 150, 250MML
71521	1 UNIVERSAL JOINT 3/8"
71632	1 ADAPTOR FOR EXTENSION 1/2"(F) X 3/8"(M)
7110302	1 DISC RATCHET 3/8", 72 TEETH
23508...32	24 FLANK SOCKET 1/2", 6 PT. 8, 9, 10, 11, 12, 13, 14, 15, 16, 17, 18, 19, 20, 21, 22, 23, 24, 25, 26, 27, 28, 29, 30, 32MM
23610...24	9 SOCKET 1/2", TX E10, E11, E12, E14, E16, E18, E20, E22, E24
7120903	1 RATCHET HANDLE 1/2" 45 TEETH
71623	1 ADAPTOR FOR EXTENSION 3/8"(F) X 1/2"(M)
7143125...250	2 EXTENSION 1/2" 125, 250MML
71531	1 UNIVERSAL JOINT 1/2"
3310117...19	3 WHEEL SOCKET 1/2", 6PT. 17, 19, 21MM
7273380	1 SWIVEL GRIP HANDLE 1/2" 380MML

308401



SOCKET SET SFS JUMBO 84-PCS

ART. NO.	CONTENTS
23508...32	22 FLANK SOCKET 1/2", 6 PT. 8, 9, 10, 11, 12, 13, 14, 15, 16, 17, 18, 19, 20, 21, 22, 23, 24, 26, 27, 28, 30, 32MM
2357708...32	22 FLANK SOCKET 1/2", 6 PT. DEEP 8, 9, 10, 11, 12, 13, 14, 15, 16, 17, 18, 19, 20, 21, 22, 23, 24, 26, 27, 28, 30, 32MM
23610...24	8 SOCKET 1/2", TX E10, E11, E12, E14, E16, E18, E20, E24
2367710...24	8 SOCKET 1/2", TX DEEP E10, E11, E12, E14, E16, E18, E20, E24
83410005...12	6 BIT SOCKET HEX 1/2", 100MML 5, 6, 7, 8, 10, 12MM
83610040...55	4 BIT SOCKET TX 1/2", 100MML T40, T45, T50, T55
83810006...14	5 BIT SOCKET SPLINE 1/2", 100MML M6, M8, M10, M12, M14
3310117...21	3 WHEEL SOCKET 1/2", 6PT. 17, 19, 21MM
732320200	1 TORQUE WRENCH 1/2" 20-200NM
7120903	1 RATCHET HANDLE 1/2" 45 TEETH
7143125...250	2 EXTENSION 1/2" 125, 250MML
71531	1 UNIVERSAL JOINT 1/2"
7233380	1 SWIVEL HANDLE 1/2" 380MML

605301



WRENCH SET SFS JUMBO 53-PCS

ART. NO.	CONTENTS
41506...32	26 COMBINATION WRENCH 6, 7, 8, 9, 10, 11, 12, 13, 14, 15, 16, 17, 18, 19, 20, 21, 22, 23, 24, 25, 26, 27, 28, 29, 30, 32MM
4170208...19	12 REVERSIBLE RATCHETING WRENCH 12PT. 8, 9, 10, 11, 12, 13, 14, 15, 16, 17, 18, 19MM
4190607...2022	8 75° OFFSET RING WRENCH 6X7, 8X9, 10X11, 12X13, 14X15, 16X17, 18X19, 20X22MM
4120809...1819	7 HINGED SOCKET WRENCH 6X7, 8X9, 10X11, 12X13, 14X15, 16X17, 18X19MM

604801

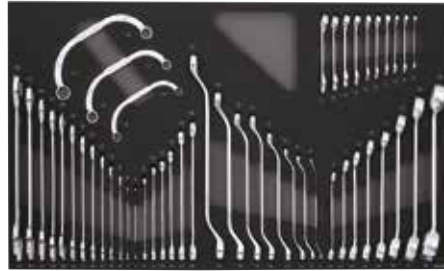

WRENCH SET SFS JUMBO, 48-PCS

ART. NO.	CONTENTS
4110810...3032	8 FLARE NUT WRENCH 8X10, 11X13, 12X14, 16X18, 17X19, 19X22, 24X27, 30X32MM
4140607...3032	12 DOUBLE OPEN WRENCH 6X7, 8X9, 10X11, 12X13, 14X15, 16X17, 18X19, 21X23, 20X22, 24X27, 25X28, 30X32MM
4180607...2123	8 45° OFFSET RING WRENCH 6X7, 8X9, 10X11, 12X13, 14X15, 16X17, 18X19, 21X23MM
4200607...1819	7 FLAT DOUBLE RING WRENCH 6X7, 8X9, 10X11, 12X13, 14X15, 16X17, 18X19MM
4211012...1417	3 HALF-MOON WRENCH 10X12, 11X13, 14X17MM
42608...17	10 STUBBY COMBINATION WRENCH 8, 9, 10, 11, 12, 13, 14, 15, 16, 17MM

604903

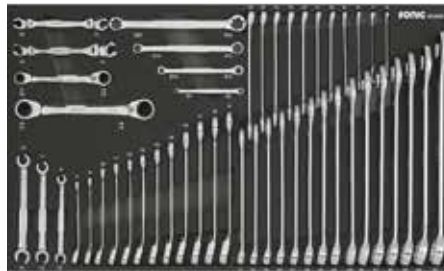

WRENCH SET SFS JUMBO, 49-PCS

ART. NO.	CONTENTS
4081011...1213	2 FLEXIBLE FLARE NUT WRENCH 10X11, 12X13MM
4110810...1214	3 FLARE NUT WRENCH 8X10, 11X13, 12X14MM
41506...32	26 COMBINATION WRENCH 6, 7, 8, 9, 10, 11, 12, 13, 14, 15, 16, 17, 18, 19, 20, 21, 22, 23, 24, 25, 26, 27, 28, 29, 30, 32MM
4160608...2024	4 STAR WRENCH E6XE8, E10XE12, E14XE18, E20XE24
4170208...19	12 12PT. REVERSIBLE GEAR WRENCH 8, 9, 10, 11, 12, 13, 14, 15, 16, 17, 18, 19MM
4170401	1 4IN1 RING RATCHET WRENCH 8-10 & 12-13MM
4170402	1 4IN1 RING RATCHET WRENCH 16-17 & 18-19MM

606901



WRENCH SET SFS JUMBO, 69-PCS

ART. NO.	CONTENTS
4110810...3032	8 FLARE NUT WRENCH 8X10, 11X13, 12X14, 16X18, 17X19, 19X22, 24X27, 30X32MM
4140607...3032	12 DOUBLE OPEN WRENCH 6X7, 8X9, 10X11, 12X13, 14X15, 16X17, 18X19, 20X22, 21X23, 24X27, 25X28, 30X32MM
4170401...02	2 4-IN-1 RING RATCHET WRENCH 8-10, 12-13; 16-17, 18-19MM
4200607...1819	9 FLAT DOUBLE RING WRENCH 6X7, 8X9, 10X11, 12X13, 14X15, 16X17, 18X19MM
4211012...1417	3 HALF-MOON WRENCH 10X12, 11X13, 14X17MM
42608...17	10 STUBBY COMBINATION WRENCH 8-10, 12, 13, 14, 15, 16, 17MM
41760608...2024	4 TX RATCHETING WRENCH E6XE8, E10XE12, E14XE18, E20XE24
4160608...2024	4 STAR WRENCH E6XE8, E10XE12, E14XE18, E20XE24
601007	10 HEXAGON KEY WRENCH, EXTRA LONG SET 10-PCS
600902	9 TX WRENCH, EXTRA LONG KEY SET 9-PCS

602204



PLIERS & CUTTING SET SFS JUMBO, 22-PCS

ART. NO.	CONTENTS
4321200	1 LONG NOSE PLIERS 8"
4331200	1 BENT LONG NOSE PLIERS 8"
4311175	1 COMBINATION PLIERS 7"
4341175	1 DIAGONAL PLIERS 7"
43611	1 SNAP RING PLIERS (STRAIGHT-OPEN)
43612	1 SNAP RING PLIERS (STRAIGHT-CLOSE)
43613	1 SNAP RING PLIERS (BENT-OPEN)
43614	1 SNAP RING PLIERS (BENT-CLOSE)
4351250	1 WATERPUMP PLIERS 10"
4380250	1 LOCKING PLIERS 10"
46701	1 STRAIGHT SHEARS
46602	1 MINI HACKSAW
46603	1 SAW BLADE 3-PCS
46806	1 UTILITY KNIFE (INCL. 10 BLADES)
47004	1 STAINLESS STEEL STRAIGHT RULE 30CM
47005	1 STAINLESS STEEL PROTRACTOR
47013	1 5M MEASURING TAPE
4471250	1 WIRE STRIPPER 10"
4820110	1 MAGNET PICKUP 10 LBS.
45602	1 AUTO CENTER PUNCH
47002	1 FEELER GAUGE 26-PCS
47003	1 STAINLESS STEEL VERNIER CALIPER

602605



PLIERS & CUTTING SET SFS JUMBO, 26-PCS

ART. NO.	CONTENTS
4311175	1 COMBINATION PLIERS 7"
4321200	1 LONG NOSE PLIERS 8"
4323275	1 LONG NOSE PLIERS 11" STRAIGHT
4331200	1 BENT LONG NOSE PLIERS 8"
4333270	1 LONG NOSE PLIERS 11" 90 DEGREE BENT
4333275	1 LONG NOSE PLIERS 11" 45 DEGREE BENT
4341175	1 DIAGONAL PLIERS 7"
4351250	1 WATERPUMP PLIERS 10"
43611	1 SNAP RING PLIERS (STRAIGHT-OPEN)
43612	1 SNAP RING PLIERS (STRAIGHT-CLOSE)
43613	1 SNAP RING PLIERS (BENT-OPEN)
43614	1 SNAP RING PLIERS (BENT-CLOSE)
4380250	1 LOCKING PLIERS 10"
4393002	1 CIRCLE NOSE PLIERS 11"-1/2"
4471250	1 WIRE STRIPPER 10"
46601	1 SUPER HEAVY DUTY HACKSAW
46701	1 STRAIGHT SHEARS
46807	1 UTILITY KNIFE ZINC ALLOY (INCL. 6 PC BLADES)
47002	1 FEELER GAUGE 26-PCS
47003	1 VERNIER CALIPER
47004	1 STAINLESS STEEL STRAIGHT RULE 30CM
47013	1 MEASURING TAPE 5 METER
4820110	1 MAGNET PICKUP 10LBS.
48212380	1 PRY BAR 380MM
4811254	1 STEEL BRUSH
4821301	1 WEDEGS (190MML X 30MMW)

603102

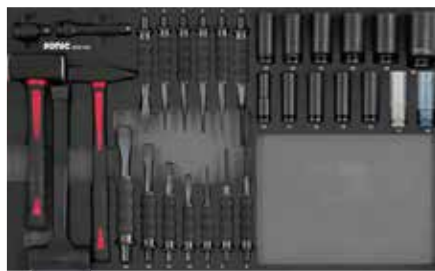

CHISEL, HAMMER & IMPACT SET SFS JUMBO, 31-PCS

ART. NO.	CONTENTS
3358513	11 1/2" 6PT. IMPACT DEEP SOCKET 13, 17, 18, 19, 21, 22, 24, 27, 30, 32, 36MM
3310117	2 1/2" 6PT. WHEEL SOCKET 17, 19MM
45110141	1 GRIP CHISEL 140MML 10"
45112160	1 GRIP CHISEL 160MML 12"
45118190	1 GRIP CHISEL 190MML 18"
45124220	1 GRIP CHISEL 220MML 24"
4527190	1 GRIP CAPE CHISEL 190MML 7"
4533150	1 GRIP PIN PUNCH 150MML 3"
4534180	1 GRIP PIN PUNCH 180MML 4"
4535200	1 GRIP PIN PUNCH 200MML 5"
4536210	1 GRIP PIN PUNCH 210MML 6"
4552185	1 GRIP TAPER PUNCH 185MML 2"
4553185	1 GRIP TAPER PUNCH 185MML 3"
4554185	1 GRIP TAPER PUNCH 185MML 4"
4564185	1 GRIP CENTER PUNCH 185MML 4"
4611400	1 MACHINIST HAMMER 400GR. FIBRE HANDLE TPR COVER
4620400	1 SAND FILLED HAMMER 400GR.
4631000	1 STONING HAMMER 1000 GR FIBRE HANDLE TPR COVER
7343125	1 1/2" IMPACT EXTENSION 125MML
73531	1 1/2" IMPACT UNIVERSAL JOINT

604001



CHISEL, HAMMER & IMPACT SET SFS JUMBO, 40-PCS

ART. NO.	CONTENTS
3358510...32	22 1/2" 6PT. IMPACT DEEP SOCKET 10, 11, 12, 13, 14, 15, 16, 17, 18, 19, 20, 21, 22, 23, 24, 25, 26, 27, 28, 29, 30, 32MM
45110141	1 GRIP CHISEL 140MML 10"
45112160	1 GRIP CHISEL 160MML 12"
45118190	1 GRIP CHISEL 190MML 18"
45124220	1 GRIP CHISEL 220MML 24"
4527190	1 GRIP CAPE CHISEL 190MML 7"
4533150	1 GRIP PIN PUNCH 150MML 3"
4534180	1 GRIP PIN PUNCH 180MML 4"
4535200	1 GRIP PIN PUNCH 200MML 5"
4536210	1 GRIP PIN PUNCH 210MML 6"
4552185	1 GRIP TAPER PUNCH 185MML 2"
4553185	1 GRIP TAPER PUNCH 185MML 3"
4554185	1 GRIP TAPER PUNCH 185MML 4"
4564185	1 GRIP CENTER PUNCH 185MML 4"
4611400	1 MACHINIST HAMMER 400GR FIBRE HANDLE TPR COVER
4631000	1 STONING HAMMER 1000GR FIBRE HANDLE TPR COVER
4620400	1 SAND FILLED HAMMER 400GR
7343125	1 1/2" IMPACT EXTENSION 125MML
73531	1 1/2" IMPACT UNIVERSAL JOINT

604202



HEX NUT & KEY GRIP SET SFS JUMBO, 42-PCS

ART. NO.	CONTENTS
12525004...13	10 SOCKET SCREWDRIVER, HEX 4, 5, 5.5, 6, 8, 9, 10, 11, 12, 13MM
47537	1 FLEXIBLE SOCKET SCREWDRIVER, HEX 7MM
1950102...08	8 T-HANDLE BALL ENDED HEXAGON KEY WRENCH, EXTRA LONG 2, 2.5, 3, 4, 5, 6, 7, 8MM
46911	1 FLAT FILE 8"
46912	1 HALF ROUND FILE 8"
46913	1 ROUND FILE 8"
46914	1 TRIANGULAR FILE 8"
600902	9 KEY WRENCH TX, EXTRA LONG SET 9-PCS, T10, T15, T20, T25, T27, T30, T40, T45, T50
601008	10 HEX BALL EXTRA LONG KEY SET 10-PCS, 1.27, 1.5, 2, 2.5, 3, 4, 5, 6, 8, 10MM

602803



HEX NUT & KEY GRIP SET SFS JUMBO, 27-PCS

ART. NO.	CONTENTS	
14423006...13	8	HEX NUT DRIVER T HANDLE 6, 7, 8, 9, 10, 11, 12, 13MM
47537...38	2	FLEXIBLE HEX NUT DRIVER 7, 8MM
1950202...8	8	HEX BALL POINT GRIP KEY 2, 2.5, 3, 4, 5, 6, 7, 8MM
46911	1	FLAT FILE 8"
46912	1	HALF ROUND FILE 8"
46913	1	ROUND FILE 8"
46914	1	TRIANGULAR FILE 8"
47901	1	DOOR UPHOLSTERY PANEL REMOVER 100MM
47902	1	DOOR UPHOLSTERY PANEL REMOVER 110MM
47904	1	COTTER PIN PULLER
47905	1	RADIATOR HOSE REMOVER
47906	1	TRIM PAD TOOL 1/4" X 115MML
4820207	1	FLEXIBLE MAGNET PICKUP 500G - 400L

47309



SFS S14 FOAM SPACER 740X145MM

ART. NO.	CONTENTS
47309	SFS S14 FOAM SPACER 740 X 145MM

B M C S
BLOW MOULD CASE STORAGE



A COMPLETE NEW PRODUCT RANGE OF TOOL STORAGE IS OUR BLOW MOULD CASE STORAGE (BMCS). THE BMCS IS A NEWLY DESIGNED SONIC PRODUCT LINE, WITH INJECTION BI-COLOR GRIP HANDLES AND METAL SPRING LOCKING CLIPS. SONIC WILL LAUNCH MULTIPLE SIZED VERSIONS WITH DIFFERENT TOOL FILLINGS IN ATTRACTIVELY DESIGNED FOAMS.

101105



TPMS SET 11-PCS BMCS

ART. NO.	CONTENTS
73310002	1 1/4"TORQUES DRIVER 0.4-2NM 3-15 INCH-POUNDS
73310109	1 1/4"TORQUES DRIVER 1-9NM 10-80 INCH-POUNDS
47825	1 TRIM REMOVAL
47826	1 TYRE VALVE DRIVER 0.25NM
47827	1 TYRE VALVE DRIVER 0.45NM
2155011...12	2 FLANK DEEP SOCKET 1/4", 6 PT. 11, 12MM
7131115	1 SLIDING T HANDLE 1/4"
7191125	1 ADAPTOR BIT 1/4"HEX-1/4"SQUARE 25MML
8163710...20	2 BIT SOCKET TX 1/4", T10, T20

104001



COMBINATION SET 1/4", 40-PCS BMCS

ART. NO.	CONTENTS
7120901	1 RATCHET HANDLE 1/4" -45 TEETH
21503...14	14 FLANK SOCKET 1/4", 6 PT. 3, 4, 4.5, 5, 5.5, 6, 7, 8, 9, 10, 11, 12, 13, 14MM
8143703...08	5 BIT SOCKET HEX 1/4", 3, 4, 5, 6, 8MM
8163710...40	6 BIT SOCKET TX 1/4", T10, T15, T20, T25, T30, T40
8133704...65	3 BIT SOCKET SLOTTED 1/4", 4, 5.5, 6.5MM
8113701...03	3 BIT SOCKET PH 1/4", PH.1, PH.2, PH.3
8123701...03	3 BIT SOCKET PZ 1/4", PZ.1, PZ.2, PZ.3
7131115	1 SLIDING T HANDLE 1/4"
7141050...100	2 EXTENSION 1/4" 50, 100MML
71511	1 UNIVERSAL JOINT 1/4"
72401	1 SPINNER 1/4" 150MML

104602



COMBINATION SET 1/4", 46-PCS BMCS

ART. NO.	CONTENTS
184-3	3 HEXAGON KEY WRENCH 1.5, 2, 2.5MM
7191125	1 ADAPTOR BIT 1/4"HEX-1/4"SQUARE 25MML
21504...14	11 FLANK SOCKET 1/4", 6 PT. 4, 5, 6, 7, 8, 9, 10, 11, 12, 13, 14MM
21545...55	2 FLANK SOCKET 1/4", 6 PT. 4.5, 5.5MM
7131115	1 SLIDING T HANDLE 1/4"
7141050...100	2 EXTENSION 1/4" 50, 100MML
71511	1 UNIVERSAL JOINT 1/4"
7211	1 FLEXIBLE EXTENSION 1/4"
72401	1 SPINNER 1/4" 150MML
8113701...03	3 BIT SOCKET PH 1/4", PH.1, PH.2, PH.3
8123701...03	3 BIT SOCKET PZ 1/4", PZ.1, PZ.2, PZ.3
8133704...65	3 BIT SOCKET SLOTTED 1/4", 4, 5.5, 6.5MM
8143703...08	6 BIT SOCKET HEX 1/4", 3, 4, 5, 6, 7, 8MM
8163710...40	6 BIT SOCKET TX 1/4", T10, T15, T20, T25, T30, T40

103502



SOCKET & BIT SET 1/4", 35-PCS BMCS

ART. NO.	CONTENTS
7120901	1 RATCHET HANDLE 1/4" -45 TEETH
21504...13	10 FLANK SOCKET 1/4", 6 PT. 4, 5, 6, 7, 8, 9, 10, 11, 12, 13MM
21545...55	2 FLANK SOCKET 1/4", 6 PT. 4.5, 5.5MM
7131115	1 SLIDING T HANDLE 1/4"
7141050	1 EXTENSION 1/4" 50MML
71511	1 UNIVERSAL JOINT 1/4"
72401	1 SPINNER 1/4" 150MML
8113700...03	4 BIT SOCKET PH 1/4", PH.0, PH.1, PH.2, PH.3
8133704	1 BIT SOCKET SLOTTED 1/4", 4MM
8133705...65	2 BIT SOCKET SLOTTED 1/4", 5.5, 6.5MM
8143703...06	4 BIT SOCKET HEX 1/4", 3, 4, 5, 6MM
8163710...40	7 BIT SOCKET TX 1/4", T10, T15, T20, T25, T27, T30, T40



107403



COMBINATION SET 1/4", 74-PCS BMCS

ART. NO.	CONTENTS
21504...13	10 FLANK SOCKET 1/4", 6 PT. 4, 5, 6, 7, 8, 9, 10, 11, 12, 13MM
2155004...13	12 FLANK DEEP SOCKET 1/4", 6 PT. 4, 4.5, 5, 5.5, 6, 7, 8, 9, 10, 11, 12, 13MM
21555	1 FLANK SOCKET 1/4", 6 PT. 5.5MM
21604...10	6 SOCKET 1/4", TX E4, E5, E6, E7 E8, E10
2165004...10	6 SOCKET 1/4", TX DEEP E4, E5, E6, E7 E8, E10
7131115	1 SLIDING T HANDLE 1/4"
7141050...100	2 EXTENSION 1/4" 50, 100MML
71511	1 UNIVERSAL JOINT 1/4"
72225	1 MAGNET SOCKET PICK-UP 1/4"
72401	1 SPINNER 1/4" 150MML
8113701...03	3 BIT SOCKET PH 1/4", PH.1, PH.2, PH.3
8123701...03	3 BIT SOCKET PZ 1/4", PZ.1, PZ.2, PZ.3
8133704...65	3 BIT SOCKET SLOTTED 1/4", 4, 5.5, 6.5MM
8143703...08	6 BIT SOCKET HEX 1/4", 3, 4, 5, 6, 7, 8MM
8163708...40	8 BIT SOCKET TX 1/4", T8, T10, T15, T20, T25, T27, T30, T40
8173708...40	8 BIT SOCKET TX TAMPERPROOF 1/4", T8, T10, T15, T20, T25, T27, T30, T40
7120901	1 RATCHET HANDLE 1/4" -45 TEETH

200804



SAMPLE SET SONIC, 8-PCS BMCS

ART. NO.	CONTENTS
7120902	1 RATCHET HANDLE 3/8" -45 TEETH
1312	1 SCREWDRIVER, PH.2
22517	1 FLANK SOCKET 3/8", 6 PT. 17MM
2256317	1 FLANK SOCKET 3/8", 6 PT. DEEP 17MM
41517	1 COMBINATION WRENCH 17M
4311175	1 COMBINATION PLIERS 7"
7110302	1 DISC RATCHET 3/8", 72 TEETH
8264840	1 BIT SOCKET TX 3/8", T40

202803



SOCKET SET 3/8", 28-PCS BMCS

ART. NO.	CONTENTS
22506...22	17 FLANK SOCKET 3/8" 6 PT. 6, 7, 8, 9, 10, 11, 12, 13, 14, 15, 16, 17, 18, 19, 20, 21, 22MM
7142044...250	4 EXTENSION 3/8" 44, 75, 150, 250MML
7120902	1 RATCHET HANDLE 3/8" -45 TEETH
71521	1 UNIVERSAL JOINT 3/8"
71632	1 ADAPTOR FOR EXTENSION 1/2"(F) X 3/8"(M)
7171216...21	3 SPARK PLUG SOCKET 3/8" 16, 18, 21MM
7232250	1 SWIVEL HANDLE 3/8" 250MML

203703



SOCKET AND WRENCH SET 3/8", 37-PCS BMCS

ART. NO.	CONTENTS
7120902	1 RATCHET HANDLE 3/8" -45 TEETH
22506...22	17 FLANK SOCKET 3/8", 6 PT. 6, 7, 8, 9, 10, 11, 12, 13, 14, 15, 16, 17, 18, 19, 20, 21, 22MM
41506...19	14 COMBINATION WRENCH 6, 7, 8, 9, 10, 11, 12, 13, 14, 15, 16, 17, 18, 19MM
7142044...150	3 EXTENSION 3/8" 44, 75, 150MML
71521	1 UNIVERSAL JOINT 3/8"
71632	1 ADAPTOR FOR EXTENSION 1/2"(F) X 3/8"(M)

204003



COMBINATION SET 3/8", 40-PCS BMCS

ART. NO.	CONTENTS
7120902	1 RATCHET HANDLE 3/8" -45 TEETH
22506...22	17 FLANK SOCKET 3/8", 6 PT. 6, 7, 8, 9, 10, 11, 12, 13, 14, 15, 16, 17, 18, 19, 20, 21, 22MM
7142044...150	3 EXTENSION 3/8" 44, 75, 150MML
71521	1 UNIVERSAL JOINT 3/8"
71632	1 ADAPTOR FOR EXTENSION 1/2"(F) X 3/8"(M)
8244804...08	5 BIT SOCKET HEX 3/8", 4, 5, 6, 7, 8MM
8264820...50	7 BIT SOCKET TX 3/8", T20, T25, T27, T30, T40, T45, T50
8284805...12	5 BIT SOCKET SPLINE 3/8", M5, M6, M8, M10, M12

206102



SOCKET & BITSOCKET SET 3/8" 61-PCS BMCS

ART. NO.	CONTENTS
7120902	1 RATCHET HANDLE 3/8" -45 TEETH
22506...24	18 FLANK SOCKET 3/8", 6 PT. 6, 7, 8, 9, 10, 11, 12, 13, 14, 15, 16, 17, 18, 19, 20, 21, 22, 24MM
2256308...19	10 FLANK SOCKET 3/8", 6 PT. DEEP 8, 9, 10, 11, 12, 13, 14, 15, 17, 19MM
7142075...250	2 EXTENSION 3/8" 75, 250MML
71521	1 UNIVERSAL JOINT 3/8"
71632	1 ADAPTOR FOR EXTENSION 1/2"(F) X 3/8"(M)
7171216...21	2 SPARK PLUG SOCKET 3/8" 16, 21MM
8214801...03	3 BIT SOCKET PH 3/8", PH.1, PH.2, PH.3
8224801...03	3 BIT SOCKET PZ 3/8", PZ.1, PZ.2, PZ.3
82348055...08	3 BIT SOCKET SLOTTED 3/8", 5.5, 7, 8MM
8244803...08	7 BIT SOCKET HEX 3/8", 3, 4, 5, 6, 7, 8, 10MM
8264810...55	10 BIT SOCKET TX 3/8", T10, T15, T20, T25, T27, T30, T40, T45, T50, T55

207601



SOCKET & BITSOCKET SET 1/2" 8-PCS BMCS

ART. NO.	CONTENTS
7120902	1 RATCHET HANDLE 3/8" -45 TEETH
22506...24	18 FLANK SOCKET 3/8", 6 PT. 6, 7, 8, 9, 10, 11, 12, 13, 14, 15, 16, 17, 18, 19, 20, 21, 22, 24MM
2256308...22	13 FLANK SOCKET 3/8", 6 PT. DEEP 8, 9, 10, 11, 12, 13, 14, 15, 16, 17, 18, 19, 22MM
8244803...10	7 BIT SOCKET HEX 3/8", 3, 4, 5, 6, 7, 8, 10MM
8214801...03	3 BIT SOCKET PH 3/8", PH.1, PH.2, PH.3
8224801...03	3 BIT SOCKET PZ 3/8", PZ.1, PZ.2, PZ.3
8234805...08	4 BIT SOCKET SLOTTED 3/8", 5.5, 6, 7, 8MM
8264808...55	11 BIT SOCKET TX 3/8", T8, T10, T15, T20, T25, T27, T30, T40, T45, T50, T55
8274810...55	10 BIT SOCKET TX TAMPERPROOF 3/8", T10H, T15H, T20H, T25H, T27H, T30H, T40H, T45H, T50H, T55H
7142075...250	2 EXTENSION 3/8" 75, 250MML
71521	1 UNIVERSAL JOINT 3/8"
7171216...21	2 SPARK PLUG SOCKET 3/8" 16, 21MM
71632	1 ADAPTOR FOR EXTENSION 1/2"(F) X 3/8"(M)

300817



BIT SOCKET TX SET 1/2" 8-PCS BMCS

ART. NO.	CONTENTS
83606227...70	8 BIT SOCKET TX 1/2", T27, T30, T40, T45, T50, T55, T60, T70

300818



TX BIT SOCKET SET 1/2" 8-PCS BMCS

ART. NO.	CONTENTS
83610027...70	8 BIT SOCKET TX 1/2", 100MML T27, T30, T40, T45, T50, T55, T60, T70

300816



BIT SOCKET HEX SET 1/2" 8-PCS BMCS

ART. NO.	CONTENTS
83410006...17	8 BIT SOCKET HEX 1/2", 100MML 6, 7, 8, 9, 10, 12, 14, 17MM

300820



BIT SOCKET SPLINE SET 1/2", 8-PCS BMCS

ART. NO.	CONTENTS
83810005...16	8 BIT SOCKET SPLINE 1/2", 100MML M5, M6, M8, M9, M10, M12, M14, M16

300821



BIT SOCKET RIBE SET 1/2" 8-PCS BMCS

ART. NO.	CONTENTS
83906206...14	8 BIT SOCKET RIBE 1/2", M6, M7, M8, M9, M10, M12, M13, M14

300819



BIT SOCKET SPLINE SET 1/2" 8-PCS BMCS

ART. NO.	CONTENTS
83806205...16	8 BIT SOCKET SPLINE 1/2", M5, M6, M8, M9, M10, M12, M14, M16

300822



BIT SOCKET RIBE SET 1/2" 8-PCS BMCS

ART. NO.	CONTENTS
83910006...14	8 BIT SOCKET RIBE 1/2", 100MML M6, M7, M8, M9, M10, M12, M13, M14

300823



BIT SOCKET HEX SET 1/2", 8-PCS BMCS

ART. NO.	CONTENTS
83406206...17	8 BIT SOCKET HEX 1/2", 6, 7, 8, 9, 10, 12, 14, 17MM

301904



SOCKET SET 1/2", 19-PCS BMCS

ART. NO.	CONTENTS
7120903	1 RATCHET HANDLE 1/2" -45 TEETH
23510...24	14 FLANK SOCKET 1/2", 6 PT. 10, 11, 12, 13, 14, 15, 16, 17, 18, 19, 21, 22, 23, 24MM
7133250	1 SLIDING T HANDLE 1/2"
7143125...250	1 EXTENSION 1/2" 125, 250MML
71531	1 UNIVERSAL JOINT 1/2"

302404



SOCKET SET 1/2", 24-PCS BMCS

ART. NO.	CONTENTS
7120903	1 RATCHET HANDLE 1/2" -45 TEETH
23510...32	18 FLANK SOCKET 1/2", 6 PT. 10, 11, 12, 13, 14, 15, 16, 17, 18, 19, 20, 21, 22, 23, 24, 27, 30, 32MM
7143125...250	2 EXTENSION 1/2" 125, 250MML
71531	1 UNIVERSAL JOINT 1/2"
71623	1 ADAPTOR FOR EXTENSION 3/8"(F) X 1/2"(M)
7233380	1 SWIVEL HANDLE 1/2" 380MML

301702



BIT SOCKET TX 1/2", 17-PCS BMCS

ART. NO.	CONTENTS
23610...24	9 SOCKET 1/2", TX E10, E11, E12, E14, E16, E18, E20, E22, E24
83606225...60	8 BIT SOCKET TX 1/2", T25, T27, T30, T40, T45, T50, T55, T60

304501



SOCKET AND WRENCH SET 1/2", 45-PCS BMCS

ART. NO.	CONTENTS
7120903	1 RATCHET HANDLE 1/2" -45 TEETH
23508...32	23 FLANK SOCKET 1/2", 6 PT. 8, 9, 10, 11, 12, 13, 14, 15, 16, 17, 18, 19, 20, 21, 22, 23, 24, 25, 26, 27, 28, 30, 32MM
7143125...250	2 EXTENSION 1/2" 125, 250MML
71531	1 UNIVERSAL JOINT 1/2"
7171316...21	2 SPARK PLUG SOCKET 1/2" 16, 21MM
71623	1 ADAPTOR FOR EXTENSION 3/8"(F) X 1/2"(M)
41506...22	15 COMBINATION WRENCH 6, 7, 8, 9, 10, 11, 12, 13, 14, 15, 16, 17, 18, 19, 22MM



TX SET IN SUITCASE 67-PCS BMCS

ART. NO.	CONTENTS
13606...40	9 SCREWDRIVER, TX T6, T8, T10, T15, T20, T25, T27, T30, T40
1860108...70	14 KEY WRENCH TX, EXTRA LONG T8, T9, T10, T15, T20, T25, T27, T30, T40, T45, T50, T55, T60, T70
21604...10	6 SOCKET 1/4", TX E4, E5, E6, E7, E8, E10
23611...24	8 SOCKET 1/2", TX E11, E12, E14, E16, E18, E20, E22, E24
4160608...2024	4 TX WRENCH E6XE8, E10XE12, E14XE18, E20XE24
8163708...40	9 BIT SOCKET TX 1/4", T8, T9, T10, T15, T20, T25, T27, T30, T40
83706250...60	3 BIT SOCKET TAMPERPROOF 1/2", TX T50H, T55H, T60H
9367520...55	7 BIT TX 10MM, 75MML T20, T25, T30, T40, T45, T50, T55
9373015...45	6 BIT TX 10MM TAMPERPROOF, 30MML T15H, T20H, T25H, T30H, T40H, T45H
72033	1 BITHALTER, 1/2"(F)X10MM(F)

SOCKET SET 1/4" & 1/2", 76-PCS BMCS

ART. NO.	CONTENTS
7120901	1 1/4" RATCHET HANDLE-45 TEETH
21504...13	12 1/4" 6PT. FLANK SOCKET 4, 4.5, 5, 5.5, 6, 7, 8, 9, 10, 11, 12, 13MM
8113701...03	3 1/4" PHILLIPS SOCKET BIT PH.1, PH.2, PH.3
8123701...03	3 1/4" POZIDRIV SOCKET BIT PZ.1, PZ.2, PZ.3
8133704...65	3 1/4" SLOTTED SOCKET BIT 4, 5.5, 6.5MM
8143703...10	7 1/4" HEX SOCKET BIT 3, 4, 5, 6, 7, 8, 10MM
8163708...40	8 1/4" STAR SOCKET BIT T8, T10, T15, T20, T25, T27, T30, T40
8173708...40	8 1/4" STAR TAMPERPROOF SOCKET BIT T8H, T10H, T15H, T20H, T25H, T27H, T30H, T40H
7120901	1 1/4" RATCHET HANDLE-45 TEETH
7131115	1 1/4" SLIDING T HANDLE
7141050...150	3 1/4" EXTENSION 50MML, 100, 150MML
71511	1 1/4" UNIVERSAL JOINT
72401	1 1/4" SPINNER 150MML
23508...32	20 1/2" 6PT. FLANK SOCKET 8, 9, 10, 11, 12, 13, 14, 15, 16, 17, 18, 19, 20, 21, 22, 23, 24, 27, 30, 32MM
7120903	1 1/2" RATCHET HANDLE-45 TEETH
7143125...250	2 1/2" EXTENSION 125, 250MML
71531	1 1/2" UNIVERSAL JOINT
71623	1 ADAPTOR FOR EXTENSION 3/8"(F) X 1/2"(M)



B M C S
BLOW MOULD CASE STORAGE



SOCKETSET IN SUITCASE 91-PCS BMCS

ART. NO.	CONTENTS
21503...14	14 1/4" 6PT. FLANK SOCKET 3, 4, 4.5, 5, 5.5, 6, 7, 8, 9, 10, 11, 12, 13, 14MM
2155006...13	8 1/4" 6PT. FLANK DEEP SOCKET 6, 7, 8, 9, 10, 11, 12, 13MM
8113701...03	3 1/4" PHILLIPS SOCKET BIT PH.1, PH.2, PH.3
8123701...03	3 1/4" POZIDRIV SOCKET BIT PZ.1, PZ.2, PZ.3
8133704...065	3 1/4" SLOTTED SOCKET BIT 4, 5.5, 6.5MM
8143703...06	4 1/4" HEX SOCKET BIT 3, 4, 5, 6MM
8163708...40	8 1/4" STAR SOCKET BIT T8, T10, T15, T20, T25, T27, T30, T40
7120901	1 1/4" RATCHET HANDLE-45 TEETH
7131115	1 1/4" SLIDING T HANDLE
7141050...100	2 1/4" EXTENSION 50, 100MML
71511	1 1/4" UNIVERSAL JOINT
72401	1 1/4" SPINNER 150MML
23510...32	14 1/2" 6PT. FLANK SOCKET 10, 13, 15, 16, 17, 18, 19, 20, 21, 22, 24, 27, 30, 32MM
2357714...19	4 1/2" 6PT. FLANK DEEP SOCKET 14, 15, 17, 19MM
7171316...21	2 1/2" SPARK PLUG SOCKET 16, 21MM
83606250...60	3 1/2" STAR SOCKET BIT T50, T55, T60
7120903	1 1/2" RATCHET HANDLE-45 TEETH
7143125...250	2 1/2" EXTENSION 125, 250MML
71531	1 1/2" UNIVERSAL JOINT
71623	1 ADAPTOR FOR EXTENSION 3/8"(F) X 1/2"(M)
72032	1 BIT HOLDER 1/2"(F) X 5/16"(F)
9213002...04	3 5/16" PHILLIPS BIT 30MML PH.2, PH.3, PH.4
9223002...04	3 5/16" POZIDRIV BIT 30MML PZ.2, PZ.3, PZ.4
9233006...12	4 5/16" SLOTTED BIT 30MML 6, 8, 10, 12MM
9263030...45	3 5/16" HEX BIT 30MML T30, T40, T45



SOCKETSET IN SUITCASE 94-PCS BMCS

ART. NO.	CONTENTS
184-3	3 HEXAGON KEY WRENCH 1.5, 2, 2.5MM
21504...14	13 1/4" 6PT. FLANK SOCKET 4, 4.5, 5, 5.5, 6, 7, 8, 9, 10, 11, 12, 13, 14MM
2155006...13	8 1/4" 6PT. FLANK DEEP SOCKET 6, 7, 8, 9, 10, 11, 12, 13MM
8113701...02	2 1/4" PHILLIPS SOCKET BIT PH.1, PH.2
8123701...02	2 1/4" POZIDRIV SOCKET BIT PZ.1, PZ.2
8133704...65	3 1/4" SLOTTED SOCKET BIT 4, 5.5, 6.5MM
8143703...06	4 1/4" HEX SOCKET BIT 3, 4, 5, 6MM
8163708...30	7 1/4" STAR SOCKET BIT T8, T10, T15, T20, T25, T27, T30
7120901	1 1/4" RATCHET HANDLE-45 TEETH
7131115	1 1/4" SLIDING T HANDLE
7141050...100	2 1/4" EXTENSION 50, 100MML
71511	1 1/4" UNIVERSAL JOINT
72401	1 1/4" SPINNER 150MML
23510...32	17 1/2" 6PT. FLANK SOCKET 10, 11, 12, 13, 14, 15, 16, 17, 18, 19, 20, 21, 22, 24, 27, 30, 32MM
2357713...22	5 1/2" 6PT. FLANK DEEP SOCKET 13, 15, 17, 19, 22MM
7171316...21	2 1/2" SPARK PLUG SOCKET 16, 21MM
7120903	1 1/2" RATCHET HANDLE-45 TEETH
7143125...250	2 1/2" EXTENSION 125, 250MML
71531	1 1/2" UNIVERSAL JOINT
71623	1 ADAPTOR FOR EXTENSION 3/8"(F) X 1/2"(M)
72032	1 BIT HOLDER 1/2"(F) X 5/16"(F)
9213003...04	2 5/16" PHILLIPS BIT 30MML PH.3, PH.4
9223003...04	2 5/16" POZIDRIV BIT 30MML PZ.3, PZ.4
9233008...12	3 5/16" SLOTTED BIT 30MML 8, 10, 12MM
9243007...14	5 5/16" HEX BIT 30MML 7, 8, 10, 12, 14MM
9263040...55	4 5/16" STAR BIT 30MML T40, T45, T50, T55

309901



SOCKETSET IN SUITCASE 99-PCS BMCS

ART. NO.	CONTENTS
21504...13	12 1/4" 6PT. FLANK SOCKET 4, 4.5, 5, 5.5, 6, 7, 8, 9, 10, 11, 12, 13MM
22510...19	10 3/8" 6PT. FLANK SOCKET 10, 11, 12, 13, 14, 15, 16, 17, 18, 19MM
23517...32	13 1/2" 6PT. FLANK SOCKET 17, 18, 19, 20, 21, 22, 23, 24, 26, 27, 28, 30, 32MM
21604...10	6 1/4" STAR SOCKET E4, E5, E6, E7, E8, E10
22611...20	6 3/8" STAR SOCKET E11, E12, E14, E16, E18, E20
41506	16 COMBINATION WRENCH 6, 7, 8, 9, 10, 11, 12, 13, 14, 15, 16, 17, 18, 19, 20, 22MM
7171316...21	2 1/2" SPARK PLUG SOCKET 16, 21MM
8113701...02	2 1/4" PHILLIPS SOCKET BIT PH.1, PH.2
8123701...02	2 1/4" POZIDRIV SOCKET BIT PZ.1, PZ.2
8133704...65	3 1/4" SLOTTED SOCKET BIT 4, 5.5, 6.5MM
8143703...06	4 1/4" HEX SOCKET BIT 3, 4, 5, 6
8163708...30	8 1/4" STAR SOCKET BIT T8, T9, T10MM, T15, T20, T25, T27, T30
7120901	1 1/4" RATCHET HANDLE-45 TEETH
7120902	1 3/8" RATCHET HANDLE-45 TEETH
7120903	1 1/2" RATCHET HANDLE-45 TEETH
7131115	1 1/4" SLIDING T HANDLE
7141050...100	2 1/4" EXTENSION 50, 100MML
7262075...150	2 3/8" WOBBLE EXTENSION 75, 150MML
7263125...250	2 1/2" WOBBLE EXTENSION 125, 250MML
71511	1 1/4" UNIVERSAL JOINT
71521	1 3/8" UNIVERSAL JOINT
71531	1 1/2" UNIVERSAL JOINT
71921	1 ADAPTOR 3/8"(F) X 1/4"(M)
71932	1 ADAPTOR 1/2"(F) X 3/8"(M)

S403



SONIC BLOWCASE 240X120X45MM

S404



SONIC BLOWCASE 280X150X45MM

S407



SONIC BLOWCASE 340X220X60MM

S409



SONIC BLOWCASE 380X250X65MM

S409-1



SONIC BLOWCASE 380X250X85MM

S413



SONIC BLOWCASE 440X310X75MM



TEAM FERRARI ATLANTA USA

Sets on rail

SONIC HAS A WIDE RANGE OF RAILS, FOR ALL KIND OF SOCKETS AND BIT SOCKETS IN 1/4", 3/8" AND 1/2" DRIVE. ALL SOCKETS/BIT SOCKETS ARE CLEARLY VISIBLE AND WELL ORGANIZED. HANG FROM HOOK OR STORE IN DRAWER.



PACKING WITH ART. NO. AND EAN-CODE

06



TOOLS ARE ALWAYS ORGANIZED



EASY CLICK-ON & CLICK-OFF FUNCTION



A VARIETY OF SONIC SOCKET AND BIT SOCKETS ON RAIL



1/4" TAMPERPROOF TX, 5 LOBES

6.3
1/4"



3/8" SHALLOW FLANK SOCKET

10
3/8"



1/2" 6PT. SHALLOW FLANK SOCKET

12.5
1/2"



3/8" DEEP SOCKET (SAE)

10
3/8"



1/4" TX SOCKET

6.3
1/4"



3/8" TX BIT SOCKET

10
3/8"



1/2" HEX BIT SOCKET (SAE)

12.5
1/2"



1/2" DEEP SOCKET (SAE)

12.5
1/2"

WORK EFFICIENT
WORK WITH SONIC



101001

SOCKET SET 1/4", ON RAIL 10-PCS

ART. NO.	DESCRIPTION
21505...13	FLANK SOCKET 1/4", 6 PT. 5, 5.5, 6, 7, 8, 9, 10, 11, 12, 13MM

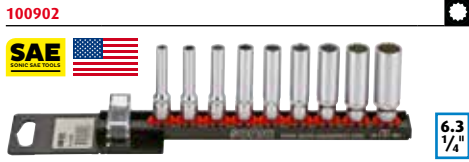

100902

DEEP SOCKET SET 1/4", ON RAIL 9-PCS

ART. NO.	DESCRIPTION
2195005...12	SOCKET 1/4", 12 PT. DEEP 3/16", 7/32", 1/4", 9/32", 5/16", 11/32", 3/8", 7/16", 1/2"



100702

BIT SOCKET SET 1/4", HEX ON RAIL 7-PCS

ART. NO.	DESCRIPTION
81413703...10	BIT SOCKET HEX 1/4" 1/8", 5/32", 3/16", 7/32", 1/4", 5/16", 3/8"



101203

FLANK SOCKET SET 1/4", 6 PT. ON RAIL 12-PCS

ART. NO.	DESCRIPTION
21504...13	FLANK SOCKET 1/4", 6 PT. 4, 4.5, 5, 5.5, 6, 7, 8, 9, 10, 11, 12, 13MM



101002

TX SOCKET SET 1/4", TX ON RAIL 10-PCS

ART. NO.	DESCRIPTION
21605...10	SOCKET 1/4", TX E5, E6, E7, E8, E10
2165005...10	SOCKET 1/4", TX DEEP E5, E6, E7, E8, E10



101004

BIT SOCKET SET 1/4", TX ON RAIL 10-PCS

ART. NO.	DESCRIPTION
8163708...25	BIT SOCKET TX 1/4", T8, T10, T15, T20, T25
8173708...25	BIT SOCKET TX TAMPERPROOF 1/4", T8H, T10H, T15H, T20H, T25H



101204

FLANK DEEP SOCKET SET 1/4", 6 PT. ON RAIL 12-PCS

ART. NO.	DESCRIPTION
2155004...13	FLANK DEEP SOCKET 1/4", 6 PT. 4, 4.5, 5, 5.5, 6, 7, 8, 9, 10, 11, 12, 13MM



100704

BIT SOCKET SET 1/4", TX WITH BALL END ON RAIL 7-PCS

ART. NO.	DESCRIPTION
81613710...40	BIT SOCKET TX BALL 1/4" T10, T15, T20, T25, T27, T30, T40

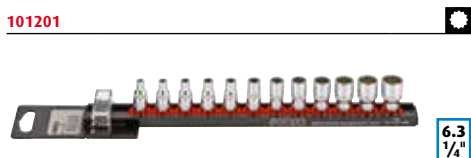

101201

SOCKET SET 1/4", 12 PT. ON RAIL 12-PCS

ART. NO.	DESCRIPTION
21804...13	SOCKET 1/4", 12 PT. 4, 4.5, 5, 5.5, 6, 7, 8, 9, 10, 11, 12, 13MM

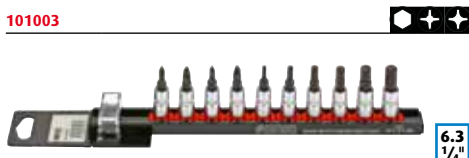

101003

BIT SOCKET SET 1/4", ON RAIL 10-PCS

ART. NO.	DESCRIPTION
8113701...02	BIT SOCKET PH 1/4", PH.1, PH.2
8123701...02	BIT SOCKET PZ 1/4", PZ.1, PZ.2
8143703...08	BIT SOCKET HEX 1/4", 3, 4, 5, 6, 7, 8MM



100701

BIT SOCKET SET 1/4", TX TAMPERPROOF ON RAIL 7-PCS

ART. NO.	DESCRIPTION
8153710...40	TAMPER-RESISTANT 1/4", TX PLUS (5 LOBES) 10IPR, 15IPR, 20IPR, 25IPR, 27IPR, 30IPR, 40IPR



101202

DEEP SOCKET SET 1/4", 12 PT. ON RAIL 12-PCS

ART. NO.	DESCRIPTION
2185004...13	SOCKET 1/4", 12 PT. DEEP 4, 4.5, 5, 5.5, 6, 7, 8, 9, 10, 11, 12, 13MM



100904

BIT SOCKET SET 1/4", HEX ON RAIL 9-PCS

ART. NO.	DESCRIPTION
8143703...10	BIT SOCKET HEX 1/4", 3, 4, 5, 5.5, 6, 7, 8, 9, 10MM



101005

BIT SOCKET SET 1/4", TX TAMPERPROOF ON RAIL 10-PCS

ART. NO.	DESCRIPTION
8153708...50	TAMPER-RESISTANT 1/4", TX PLUS (5 LOBES) 8IPR, 10IPR, 15IPR, 20IPR, 25IPR, 27IPR, 30IPR, 40IPR, 45IPR, 50IPR

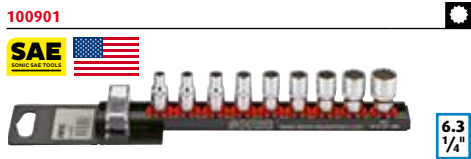

100901

SOCKET SET 1/4", ON RAIL 9-PCS

ART. NO.	DESCRIPTION
21905...13	SOCKET 1/4", 12 PT. 3/16", 7/32", 1/4", 9/32", 5/16", 11/32", 3/8", 7/16", 1/2"



100903

BIT SOCKET SET 1/4", HEX WITH BALL END ON RAIL 9-PCS

ART. NO.	DESCRIPTION
8103703...10	BIT SOCKET HEX BALL 1/4", 3, 4, 5, 5.5, 6, 7, 8, 9, 10MM



100501

BIT SOCKET SET 1/4", TX ON RAIL 5-PCS

ART. NO.	DESCRIPTION
8183704...10	BIT SOCKET SPLINE 1/4", M4, M5, M6, M8, M10



100601

BIT SOCKET SET 1/4", RIBE ON RAIL 6-PCS

ART. NO.	DESCRIPTION
8193704...10	BIT SOCKET RIBE 1/4", M4, M5, M6, M7, M8, M10



200802

DEEP SOCKET SET 3/8", ON RAIL 8-PCS

ART. NO.	DESCRIPTION
2296310...21	SOCKET 3/8", 12 PT. DEEP 3/8", 7/16", 1/2", 9/16", 5/8", 11/16", 3/4", 13/16"



200902

BIT SOCKET HEX SET 3/8", ON RAIL 9-PCS

ART. NO.	DESCRIPTION
82414803...13	BIT SOCKET HEX 3/8", 1/8", 5/32", 3/16", 7/32", 1/4", 5/16", 3/8", 7/16", 1/2"



201001

SOCKET SET 3/8", ON RAIL 10-PCS

ART. NO.	DESCRIPTION
22508...17	FLANK SOCKET 3/8", 6 PT. DEEP 8, 9, 10, 11, 12, 13, 14, 15, 16, 17MM



201002

SOCKET SET 3/8", TX ON RAIL 10-PCS

ART. NO.	DESCRIPTION
22610...16	SOCKET 3/8", TX E10, E11, E12, E14, E16
2266310...16	SOCKET 3/8", TX DEEP E10, E11, E12, E14, E16



201008

FLANK DEEP SOCKET 3/8", 6 PT. ON RAIL 10-PCS

ART. NO.	DESCRIPTION
2256308...17	FLANK SOCKET 3/8", 6 PT. DEEP 8, 9, 10, 11, 12, 13, 14, 15, 16, 17MM



201014

CARDAN SOCKET SET 3/8", 12 PT. ON RAIL 10-PCS

ART. NO.	DESCRIPTION
7152810...19	CARDAN SOCKET 3/8" 10, 11, 12, 13, 14, 15, 16, 17, 18, 19MM



201005

BIT SOCKET SET 3/8", TX ON RAIL 10-PCS

ART. NO.	DESCRIPTION
8264808...50	BIT SOCKET TX 3/8" T8, T10, T15, T20, T25, T27, T30, T40, T45, T50



201009

FLANK SOCKET SET 3/8", 12 PT. ON RAIL 10-PCS

ART. NO.	DESCRIPTION
22808...19	SOCKET 3/8", 12 PT. DEEP 8, 10, 11, 12, 13, 14, 15, 16, 17, 19MM



201003

BIT SOCKET SET 3/8", HEX ON RAIL 10-PCS

ART. NO.	DESCRIPTION
8244803...12	BIT SOCKET HEX 3/8", 3, 4, 5, 5.5, 6, 7, 8, 9, 10, 12MM



201012

BIT SOCKET SET 3/8", TX LONG ON RAIL 10-PCS

ART. NO.	DESCRIPTION
8269008...50	BIT SOCKET TX 3/8", 90MML T8, T10, T15, T20, T25, T27, T30, T40, T45, T50



201010

FLANK DEEP SOCKET SET 3/8", 12 PT. ON RAIL 10-PCS

ART. NO.	DESCRIPTION
2286308...19	SOCKET 3/8", 12 PT. DEEP 8, 10, 11, 12, 13, 14, 15, 16, 17, 19MM



200903

HEX LONG BIT SOCKET SET 3/8", ON RAIL 9-PCS

ART. NO.	DESCRIPTION
8249003...10	BIT SOCKET HEX 3/8", 90MML 3, 4, 5, 5.5, 6, 7, 8, 9, 10MM



201006

BIT SOCKET SET 3/8", TX TAMPERPROOF ON RAIL 10-PCS

ART. NO.	DESCRIPTION
8274808...50	BIT SOCKET TX TAMPERPROOF 3/8", T8H, T10H, T15H, T20H, T25H, T27H, T30H, T40H, T45H, T50H



200801

SOCKET SET 3/8", ON RAIL 8-PCS

ART. NO.	DESCRIPTION
22910...21	SOCKET 3/8", 12 PT. DEEP 3/8", 7/16", 1/2", 9/16", 5/8", 11/16", 3/4", 13/16"



200901

BIT SOCKET HEX BALL SET 3/8", ON RAIL 9-PCS

ART. NO.	DESCRIPTION
8209003...10	BIT SOCKET HEX BALL 3/8", 3, 4, 5, 5.5, 6, 7, 8, 9, 10MM



201013

BIT SOCKET SET 3/8", TX TAMPERPROOF ON RAIL 10-PCS

ART. NO.	DESCRIPTION
8279008...50	BIT SOCKET TX TAMPERPROOF 3/8", 90MML T8H, T10H, T15H, T20H, T25H, T27H, T30H, T40H, T45H, T50H

201201



10
3/8"

BIT SOCKET SET 3/8", RIBE & TRIPLE SQUARE ON RAIL 12PT. 12-PCS

ART. NO.	DESCRIPTION
8284805...12	BIT SOCKET SPLINE 3/8", M5, M6, M8, M9, M10, M12
8294805...10	BIT SOCKET RIBE 3/8", M5, M6, M7, M8, M9, M10

301202



12.5
1/2"

DEEP SOCKET SET 1/2", ON RAIL 12-PCS

ART. NO.	DESCRIPTION
2357708...19	FLANK SOCKET 1/2", 6 PT. DEEP 8, 9, 10, 11, 12, 13, 14, 15, 16, 17, 18, 19MM

301503



12.5
1/2"

SOCKET SET 1/2", ON RAIL 15-PCS

ART. NO.	DESCRIPTION
23910...32	SOCKET 1/2", 12 PT. 3/8", 7/16", 1/2", 9/16", 5/8", 11/16", 3/4", 13/16", 7/8", 15/16", 1", 1.1/16", 1.1/8", 1.3/16", 1.1/4"

200805



6.3
1/4" 10
3/8"

1/4" & 3/8" PORSCHE 10MM SOCKETS ON RAIL 8-PCS

ART.NO.	DESCRIPTION
21510	1/4" 6PT. FLANK SOCKET 10MM
2155010	1/4" 6PT. FLANK DEEP SOCKET 10MM
22510	3/8" 6PT. FLANK SOCKET 10MM
2256310	3/8" 6PT. FLANK DEEP SOCKET 10MM
71511	1/4" UNIVERSAL JOINT
7151810	1/4" 12PT. CARDAN SOCKET 10MM
71521	3/8" UNIVERSAL JOINT
7152810	3/8" CARDAN SOCKET 10MM

301504



12.5
1/2"

DEEP SOCKET SET 1/2", ON RAIL 15-PCS

ART. NO.	DESCRIPTION
2397710...32	SOCKET 1/2", 12 PT. DEEP 3/8", 7/16", 1/2", 9/16", 5/8", 11/16", 3/4", 13/16", 7/8", 15/16", 1", 1.1/16", 1.1/8", 1.1/8", 1.3/16", 1.1/4"

300902



12.5
1/2"

SOCKET SET 1/2", TX ON RAIL 9-PCS

ART. NO.	DESCRIPTION
23610...24	SOCKET 1/2", TX E10, E11, E12, E14, E16, E18, E20, E22, E24

201015



12.5
1/2"

1/4" & 3/8" VW/ AUD SOCKETSET ON RAIL 10-PCS

ART.NO.	DESCRIPTION
21510...13	1/4" 6PT. FLANK SOCKET 10, 13MM
8163720...30	1/4" STAR SOCKET BIT T20, T25, T30
8244805...06	3/8" HEX SOCKET BIT 5, 6MM
8284806...10	3/8" SPLINE SOCKET BIT M6, M8, M10

300903



12.5
1/2"

DEEP SOCKET SET 1/2", TX ON RAIL 9-PCS

ART. NO.	DESCRIPTION
2367710...24	SOCKET 1/2", TX DEEP E10, E11, E12, E14, E16, E18, E20, E22, E24

301201



12.5
1/2"

SOCKET SET 1/2", ON RAIL, 12-PCS

ART. NO.	DESCRIPTION
23508...19	FLANK SOCKET 1/2", 6 PT. 8, 9, 10, 11, 12, 13, 14, 15, 16, 17, 18, 19MM

301203



12.5
1/2"

SOCKET SET 1/2", 12 PT. ON RAIL 12-PCS

ART. NO.	DESCRIPTION
23808...19	SOCKET 1/2", 12 PT. 8, 9, 10, 11, 12, 13, 14, 15, 16, 17, 18, 19MM

301003



12.5
1/2"

BIT SOCKET SET 1/2", HEX ON RAIL 10-PCS

ART. NO.	DESCRIPTION
83406204...14	BIT SOCKET HEX 1/2" 4, 5, 5.5, 6, 7, 8, 9, 10, 12, 14MM

301007



12.5
1/2"

SOCKET SET 1/2", ON RAIL, 10-PCS

ART. NO.	DESCRIPTION
23510...24	FLANK SOCKET 1/2", 6 PT. 11, 12, 13, 14, 15, 17, 19, 21, 24MM

301204



12.5
1/2"

DEEP SOCKET SET 1/2", 12 PT. ON RAIL 12-PCS

ART. NO.	DESCRIPTION
2387708...19	SOCKET 1/2", 12 PT. DEEP 8, 9, 10, 11, 12, 13, 14, 15, 16, 17, 18, 19MM

301002



12.5
1/2"

BIT SOCKET SET 1/2", HEX ON RAIL 10-PCS

ART. NO.	DESCRIPTION
834106205...17	BIT SOCKET HEX 1/2" 3/16", 1/4", 9/32", 5/16", 11/32", 3/8", 7/16", 1/2", 9/16", 5/8"

301005



12.5
1/2"

BIT SOCKET SET 1/2", TX ON RAIL 10-PCS

ART. NO.	DESCRIPTION
83606220...70	BIT SOCKET TX 1/2", T20, T25, T27, T30, T40, T45, T50, T55, T60, T70

301006



12.5
1/2"

BIT SOCKET SET 1/2", TX TAMPERPROOF ON RAIL 10-PCS

ART. NO.	DESCRIPTION
83706220...70	BIT SOCKET TAMPERPROOF 1/2", TX T20H, T25H, T27H, T30H, T40H, T45H, T50H, T55H, T60H, T70H

300906



12.5
1/2"

BIT SOCKET SET 1/2", TRIPLE SQUARE ON RAIL 9-PCS

ART. NO.	DESCRIPTION
83806205...16	BIT SOCKET SPLINE 1/2", M5, M6, M8, M9, M10, M12, M14, M16
83806216T	BIT SOCKET SPLINE 1/2", M16-T

301008



12.5
1/2"

BIT SOCKET SET 1/2", RIBE ON RAIL 10-PCS

ART. NO.	DESCRIPTION
83906205...14	BIT SOCKET RIBE 1/2", M5, M6, M7, M8, M9, M10, M10-1, M12, M13, M14

300308



UNIVERSAL JOINT 3-PCS

INDISPENSABLE MOUNTING AID WHEN EXTENSIONS ARE USED
PREVENTS THE MOUNTING CONNECTION SAGGING TOO MUCH

ART. NO.	DESCRIPTION
300308-1	1/4" UNIVERSAL JOINT
300308-2	3/8" UNIVERSAL JOINT
300308-3	1/2" UNIVERSAL JOINT

300814



ADAPTOR & UNIVERSAL JOINT 8-PCS

ART. NO.	DESCRIPTION
-	ADAPTOR 1/4"(F)X6MM(F)
71912	ADAPTOR 1/4"(F) X 3/8"(M)
71511	UNIVERSAL JOINT 1/4"
71921	ADAPTOR 3/8"(F) X 1/4"(M)
71923	ADAPTOR 3/8"(F)X 1/2"(M)
71521	UNIVERSAL JOINT 3/8"
71932	ADAPTOR 1/2"(F)X 3/8"(M)
71531	UNIVERSAL JOINT 1/2"



C. ABT BENTLEY, GERMANY



SONIC TECHNICAL PARTNER
equipment



Tools sets

601001



16 IN 1 RATCHET SCREWDRIVER

ART. NO.	PCS	CONTENTS
601001-1	1	RATCHET GRIP
601001-2	1	BIT HOLDER
601001-3	1	BIT PH.1+PH.2
601001-4	1	BIT PZ.1+PZ.2
601001-5	1	BIT SLOTTED 3.5MM+5MM
601001-6	1	BIT 1/4" DRIVER
601001-7	1	BIT T10+T15
601001-8	1	BIT T20+T25
601001-9	1	BIT T27+T30
601001-10	1	BIT HEX 3MM+4MM

600503



SCREWDRIVER SET IN COLOUR BOX 5-PCS

ART. NO.	PCS	CONTENTS
1111...2	2	SCREWDRIVER PH.1, PH.2
11304...65	3	SCREWDRIVER, SLOTTED 4, 5.5, 6.5MM

600512



SCREWDRIVER SET IN COLOUR BOX 5-PCS

ART. NO.	PCS	CONTENTS
1311...2	2	SCREWDRIVER, PH.1, PH.2
13304...65	3	SCREWDRIVER, SLOTTED 4, 5.5, 6.5MM

600618



6-PCS SCREWDRIVER SET IN COLOUR BOX

ART. NO.	PCS	CONTENTS
1311...12	2	SCREWDRIVER PH.1, PH.2
13303...65	4	SLOTTED SCREWDRIVER 3, 4, 5.5, 6.5MM

600619



6-PCS SCREWDRIVER SET TX IN COLOUR BOX

ART. NO.	PCS	CONTENTS
13610...30	6	SCREWDRIVER, TX T10, T15, T20, T25, T27, T30

600620



6-PCS SCREWDRIVER SET TX-H IN COLOUR BOX

ART. NO.	PCS	CONTENTS
13710...30	6	SCREWDRIVER, TX TAMPERPROOF T10H, T15H, T20H, T25H, T27H, T30H

602006



SCREWDRIVER SET, 20-PCS

ART.NO.	PCS	CONTENTS
1311...3	3	SCREWDRIVER, PH.1, PH.2, PH.3
1312S	1	SCREWDRIVER, STUBBY PH.2
1321...3	3	SCREWDRIVER, PZ.1, PZ.2, PZ.3
1322S	1	SCREWDRIVER, STUBBY PZ.2
13303...8	5	SCREWDRIVER, SLOTTED 3, 4, 5.5, 6.5, 8MM
133065S	1	SCREWDRIVER, STUBBY SLOTTED 6.5MM
13610...30	6	SCREWDRIVER, TX T10, T15, T20, T25, T27, T30

600603

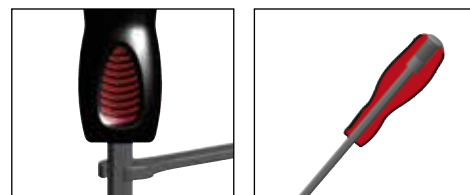

GO-THROUGH SCREWDRIVER SET 6-PCS

ART. NO.	PCS	CONTENTS
1511...3	3	HAMMER SCREWDRIVER PH.1, PH.2, PH.3
15355...08	3	HAMMER SLOTTED SCREWDRIVER 5.5, 6.5, 8MM

600514



GO-THROUGH SCREWDRIVER SET 5-PCS

ART. NO	PCS	CONTENTS
15101	1	HAMMER GO-THROUGH SCREWDRIVER, PH.1 (S)
15102	1	HAMMER GO-THROUGH SCREWDRIVER, PH.2 (S)
1530155	1	HAMMER GO-THROUGH SCREWDRIVER, SLOTTED 5.5MM (S)
1530165	1	HAMMER GO-THROUGH SCREWDRIVER, SLOTTED 6.5MM (S)
1530108	1	HAMMER GO-THROUGH SCREWDRIVER, SLOTTED 8MM (S)

602303

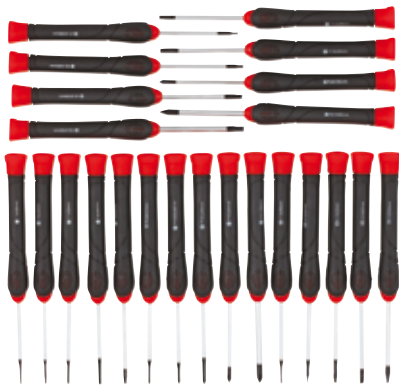

PRECISION SCREWDRIVER SET, 23-PCS

ART. NO	PCS	CONTENTS
602303-1...5	5	SCREWDRIVER PH.0000, PH.000, PH.00, PH.0, PH.1
602303-6...7	2	SCREWDRIVER PZ.0, PZ.1
602303-8...12	5	SCREWDRIVER, SLOTTED 1.5, 2, 2.5, 3, 3.5MM
602303-13...16	4	SCREWDRIVER, HEX 1.5, 2, 2.5, 3MM
602303-17...23	7	SCREWDRIVER, TX T5, T6, T7, T8, T9, T10, T15

601503



IMPACT DRIVER SET, 15-PCS

ART. NO.	PCS	CONTENTS
72501	1	IMPACT DRIVER
9243604...08	4	BIT HEX 5/16", 36MML 4, 5, 6, 8MM
9233605...12	5	BIT SLOTTED 5/16", 36MML 5, 6, 8, 10, 12MM
9213601...04	4	BIT PH 5/16", 36MML PH.1, PH.2, PH.3, PH.4
72032	1	BIT HOLDER 1/2"(F) X 5/16"(F)

600919



POCKET BITS, 9-PCS

103101



BIT SET 1/4", 31-PCS

ART. NO.	PCS	CONTENTS
103101-1	1	RATCHET 1/4"
103101-2...4	3	BIT PH.1, PH.2, PH.3
103101-5...7	3	BIT PZ.1, PZ.2, PZ.3
103101-8...12	5	BIT SLOTTED 3.5, 4.5, 5.5, 6.5, 8MM
103101-13...19	7	BIT HEX 2, 3, 4, 5, 6, 7, 8MM
103101-20...29	10	BIT TX T7, T8, T9, T10, T15, T20, T25, T27, T30, T40
103101-30...31	2	BIT ROBERTSON R1, R2

103201



BITSET 32-PCS

PCS	CONTENTS
1	BIT HOLDER 1/4"(F)X1/4"(M) 65MML
1	BIT ADAPTOR 1/4"(F)X1/4"(F) 25MML
4	1/4" BIT SLOTTED 25MML 3, 4, 5.5, 6.5MM
4	1/4" BIT PH 25MML PH.1, PH.2, PH.3, PH.4
4	1/4" BIT PZ 25MML PZ.1, PZ.2, PZ.3, PZ.4
6	1/4" BIT HEX 25MML 2, 2.5, 3, 4, 5, 6MM
6	1/4" BIT TX 25MML T10, T15, T20, T25, T30, T40
6	1/4" BIT TX TAMPERPROOF 25MML T10H, T15H, T20H, T25H, T30H, T40H

102801



1/4" SOCKET & BIT SET, 28-PCS

101901



DISC RATCHET SET 1/4", 19-PCS

ART. NO.	PCS	CONTENTS
21506...12	5	FLANK SOCKET 1/4", 6 PT. 6, 8, 9, 10, 12MM
7110301	1	DISC RATCHET 1/4", 72 TEETH
7141050	1	EXTENSION 1/4" 50MML
72011	1	BIT HOLDER 1/4"(F) X 1/4"(F)
9112501...03	3	BIT PH 1/4", 25MML PH.1, PH.2, PH.3
9132503...06	4	BIT SLOTTED 1/4", 25MML 3, 4, 5, 6MM
9142503...05	3	BIT HEX 1/4", 25MML 3, 4, 5MM

206101



SOCKET & BIT SOCKET SET 3/8", 61-PCS

ART. NO.	PCS	CONTENTS
22506...24	18	FLANK SOCKET 3/8", 6 PT. 6, 7, 8, 9, 10, 11, 12, 13, 14, 15, 16, 17, 18, 19, 20, 21, 22, 24MM
2256308...19	10	FLANK SOCKET 3/8", 6 PT. DEEP 8, 9, 10, 11, 12, 13, 14, 15, 17, 19MM
8244803...10	7	BIT SOCKET HEX 3/8", 3, 4, 5, 6, 7, 8, 10MM
8214801...03	3	BIT SOCKET PH 3/8", PH.1, PH.2, PH.3
8224801...03	3	BIT SOCKET PZ 3/8", PZ.1, PZ.2, PZ.3
82348055...08	3	BIT SOCKET SLOTTED 3/8", 5.5, 7, 8MM
8264810...55	10	BIT SOCKET TX 3/8", T10, T15, T20, T25, T27, T30, T40, T45, T50, T55
7120202	1	RATCHET HANDLE 3/8" 24 TEETH
7142075...250	2	EXTENSION 3/8" 75MML, 250MML
71521	1	UNIVERSAL JOINT 3/8"
7171216...21	2	SPARK PLUG SOCKET 3/8" 16MM, 21MM
71632	1	ADAPTOR FOR EXTENSION 1/2"(F) X 3/8"(M)
7211	1	FLEXIBLE EXTENSION 1/4"
184-3	3	HEXAGON KEY WRENCH 1.5, 2, 2.5MM

309401



SOCKET SET IN SUITCASE 94-PCS

ART. NO.	PCS	CONTENTS
21504...14	13	FLANK SOCKET 1/4", 6 PT. 4, 4.5, 5, 5.5, 6, 7, 8, 9, 10, 11, 12, 13, 14MM
2155006...13	8	FLANK DEEP SOCKET 1/4", 6 PT. 6, 7, 8, 9, 10, 11, 12, 13MM
8143703...06	4	BIT SOCKET HEX 1/4", 3, 4, 5, 6MM
8163708...30	7	BIT SOCKET TX 1/4", T8, T10, T15, T20, T25, T27, T30
8133704...65	3	BIT SOCKET SLOTTED 1/4", 4, 5.5, 6.5MM
8113701...02	2	BIT SOCKET PH 1/4", PH.1, PH.2
8123701...02	2	BIT SOCKET PZ 1/4", PZ.1, PZ.2
7120201	1	RATCHET HANDLE 1/4" 24 TEETH
7131115	1	SLIDING T HANDLE 1/4"
7141050...100	2	EXTENSION 1/4" 50MML, 100MML
71511	1	UNIVERSAL JOINT 1/4"
72401	1	SPINNER 1/4" 150MML
184-3	3	HEXAGON KEY WRENCH 1.5, 2, 2.5MM
23510...32	17	FLANK SOCKET 1/2", 6 PT. 10, 11, 12, 13, 14, 15, 16, 17, 18, 19, 20, 21, 22, 24, 27, 30, 32MM
2357713...22	5	FLANK SOCKET 1/2", 6 PT. DEEP 13, 15, 17, 19, 22MM
7120203	1	RATCHET HANDLE 1/2" 24 TEETH
7143125...250	2	EXTENSION 1/2" 125MML, 250MML
71531	1	UNIVERSAL JOINT 1/2"
7171316...21	2	SPARK PLUG SOCKET 1/2" 16, 21MM
71623	1	ADAPTOR FOR EXTENSION 3/8"(F) X 1/2"(M)
72032	1	BIT HOLDER 1/2"(F) X 5/16"(F)
9243007...14	5	BIT HEX 10MM, 30MML 7, 8, 10, 12, 14MM
9263040...55	4	BIT TX 5/16", 30MML T40, T45, T50, T55
9233008...12	3	BIT SLOTTED 5/16", 30MML 8, 10, 12MM
9213003...04	2	BIT PH 5/16", 30MML PH.3, PH.4
9223003...04	2	BIT PZ 5/16", 30MML PZ.3, PZ.4

307301



TX SET IN SUITCASE 73-PCS

ART. NO.	PCS	CONTENTS
307301-1...7	7	SOCKET 1/4" TX E4, E5, E6, E7, E8, E10, E11
307301-8...13	6	BIT SOCKET 1/4" TX T8, T10, T15, T20, T25, T27
307301-14...20	7	SOCKET 1/2" TX E12, E14, E16, E18, E20, E22, E24
307301-21...26	6	BIT SOCKET 1/2" TX T30, T40, T45, T50, T55, T60
307301-27	1	COUPLER 1/2" X 10MM
307301-54...63	10	10MM X 30MM(L) BITS T10H, T15H, T20H, T25H, T27H, T30H, T40H, T45H, T50H, T55H
307301-64-73	10	10MM X 75MM(L) BITS T10, T15, T20, T25, T27, T30, T40, T45, T50, T55
307301-28...31	4	DOUBLE RING SPANNER TX E-6X8, E-10X12, E14X18, E20X24
307301-32...44	13	L-TYPE WRENCH TX T8, T10, T15, T20, T25, T27, T30, T40, T45, T50, T55, T60, T70
307301-45-53	9	SCREWDRIVER, TX T6, T8, T10, T15, T20, T25, T27, T30, T40

301601



MULTI FUNCTION SOCKET SET 1/2", 16-PCS

- SIZES 8 - 24MM. THE SONIC MULTI GRIP SOCKET SET IS A NEW DESIGN. NOW INSTEAD OF 4 SOCKETS, 1 SONIC MULTI GRIP SOCKET WILL DO THE TRICK. THE PROFILE OF THE MULTI GRIP SOCKET IS CAPABLE OF REMOVING AND TIGHTENING - METRIC, HEX, STAR, SQUARE, SAE

ART. NO.	MULTI GRIP SOCKET	HEX MM	HEX INCH	STAR	SQUARE MM	SQUARE INCH	12PT. MM	12PT. INCH
301601-1	8	8	5/16"	E10	7	9/32"	8	5/16"
301601-2	9	9	11/32"	-	8	5/16"	9	11/32"
301601-3	10	10	3/8"	E12	9	11/32"	10	3/8"
301601-4	11	11	7/16"	E14	10	3/8"	11	7/16"
301601-5	12	12	15/32"	E16	-	-	12	15/32"
301601-6	13	13	1/2"	-	11	7/16"	13	1/2"
301601-7	14	14	9/16"	E18	12	15/32"	14	9/16"
301601-8	15	15	19/32"	-	13	1/2"	15	19/32"
301601-9	16	16	5/8"	E20	14	9/16"	16	5/8"
301601-10	17	17	11/16"	-	15	-	17	11/16"
301601-11	18	18	23/32"	E22	-	-	18	23/32"
301601-12	19	19	3/4"	E24	16	5/8"	19	3/4"
301601-13	20	20	25/32"	-	17	11/16"	20	25/32"
301601-14	21	21	13/16"	-	18	23/32"	21	13/16"
301601-15	22	22	7/8"	-	19	3/4"	22	7/8"
301601-16	24	24	15/16"	-	21	13/16"	24	15/16"

402001

SOCKET SET 3/4", 12 PT. 20-PCS

ART. NO.	PCS	CONTENTS
24919...50	16	SOCKET 3/4", 12 PT. 19, 21, 22, 23, 24, 26, 27, 29, 30, 32, 35, 36, 38, 41, 46, 50MM
7121204	1	RATCHET HANDLE 3/4" 24 TEETH
7134450	1	SLIDING T HANDLE 3/4"
7144100...200	2	EXTENSION 3/4"

501401

SOCKET SET 1", 12 PT. 15-PCS

ART. NO.	PCS	CONTENTS
25836...80	10	SOCKET 1", 12 PT. 36, 41, 46, 50, 55, 60, 65, 70, 75, 80MM
7121205	1	RATCHET HANDLE 1" 24 TEETH
7135550	1	SLIDING T HANDLE 1"
7135	1	SLIDING T HANDLE 1" HEAD
7145200...400	2	EXTENSION 1"

300308

UNIVERSAL JOINT 3-PCS

INDISPENSABLE MOUNTING AID WHEN EXTENSIONS ARE USED PREVENTS THE MOUNTING CONNECTION SAGGING TOO MUCH

ART. NO.	PCS	CONTENTS
300308-1	1	1/4" UNIVERSAL JOINT
300308-2	1	3/8" UNIVERSAL JOINT
300308-3	1	1/2" UNIVERSAL JOINT

300814

ADAPTOR & UNIVERSAL JOINT 8-PCS

- UNIVERSAL JOINTS: 1/4", 3/8", 1/2"
 - ADAPTORS: 1/4"(F)X6MM(F), 1/4"(F)X3/8"(M), 3/8"(F)X1/4"(M), 1/2"(F)X3/8"(M), 3/8"(F)X1/2"(M)

300603

ADAPTOR SET 6-PCS

ART. NO.	PCS	CONTENTS
71912	1	1/4"(F) X 3/8"(M)
71921	1	3/8"(F) X 1/4"(M)
71923	1	3/8"(F) X 1/2"(M)
71932	1	1/2"(F) X 3/8"(M)
71934	1	1/2"(F) X 3/4"(M)
71943	1	3/4"(F) X 1/2"(M)

300605

IMPACT ADAPTOR SET 6-PCS

ART. NO.	PCS	CONTENTS
73612	1	IMPACT ADAPTOR 1/4"(F) X 3/8"(M)
73621	1	IMPACT ADAPTOR 3/8"(F) X 1/4"(M)
73623	1	IMPACT ADAPTOR 3/8"(F) X 1/2"(M)
73632	1	IMPACT ADAPTOR 1/2"(F) X 3/8"(M)
73634	1	IMPACT ADAPTOR 1/2"(F) X 3/4"(M)
73643	1	IMPACT ADAPTOR 3/4"(F) X 1/2"(M)

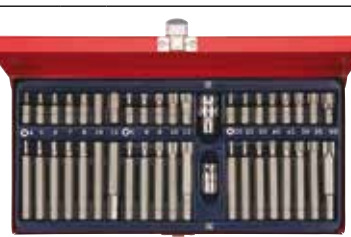
304201

BIT SET 10MM 42-PCS

ART. NO.	PCS	CONTENTS
9343004...12	7	BIT HEX 10MM, 30MML 4, 5, 6, 7, 8, 10, 12MM
9347504...12	7	BIT HEX 10MM, 75MML 4, 5, 6, 7, 8, 10, 12MM
9363020...60	8	BIT TX 10MM, 30MML T20, T25, T30, T40, T45, T50, T55, T60
9367520...60	8	BIT TX 10MM, 75MML T20, T25, T30, T40, T45, T50, T55, T60
9383005...12	5	BIT SPLINE 10MM, 30MML M5, M6, M8, M10, M12
9387505...12	5	BIT SPLINE 10MM, 75MML M5, M6, M8, M10, M12
72023...33	2	BIT HOLDER 3/8"(F) X 10MM(F), 1/2"(F) X 10MM(F)

NOTE: CERTAIN T40 STAR FASTENERS ARE GLUED INTO PLACE WITH LOCTITE. THIS GLUE MUST BE MELTED WITH A HOT AIR GUN BEFORE ATTEMPTING TO REMOVE THE BOLT OR DAMAGE MAY RESULT TO THE T40 STAR BIT.

807001

HUB NUT IMPACT SOCKET SET 1/2", 12-PT. 3-PCS

- A SET OF THREE THIN WALLED, BI-HEX IMPACT SOCKETS SPECIFICALLY DESIGNED FOR FRONT HUB NUTS
 - MANUFACTURED FROM CHROME MOLYBDENUM

ART. NO.	PCS	CONTENTS
807001-1	1	HUB NUT IMPACT SOCKET SET 1/2", 12-PT 30
807001-2	1	HUB NUT IMPACT SOCKET SET 1/2", 12-PT 32
807001-3	1	HUB NUT IMPACT SOCKET SET 1/2", 12-PT 36

300602

HUB NUT IMPACT SOCKET SET 1/2", 6-PCS

- A SET WITH 3 THIN WALLED BI-HEX IMPACT SOCKETS SPECIFICALLY DESIGNED FOR FRONT HUB NUTS
 - MANUFACTURED FROM CHROME MOLYBDENUM (CR-MO)

ART. NO.	PCS	CONTENTS
3398530...36	3	IMPACT DEEP SOCKET 85MML 30, 32, 36MML
86404314...19	3	IMPACT HEX SOCKET BIT ONE-PIECE 43MML 14, 17, 19

300910

IMPACT DEEP E SOCKET SET 1/2", 9-PCS

SUITABLE FOR USE WITH IMPACT WRENCH, WITH GROOVE AND BORE HOLE FOR BALL

ART. NO.	PCS	CONTENTS
3367810...24	9	IMPACT SOCKET 1/2", TX 78MML E10, E11, E12, E14, E16, E18, E20, E22, E24

300601

IMPACT BIT SOCKET SET 1/2", 6-PCS

- 3 THIN WALLED BI-HEX IMPACT SOCKETS SPECIFICALLY DESIGNED FOR FRONT HUB NUTS
 - MANUFACTURED FROM CHROME MOLYBDENUM (CR-MO)

SIZES	PCS	CONTENTS
BIT SOCKETS 43MML	3	M14, M16, M18
BIT SOCKETS 78MML	3	M14, M16, M18

601401



COMBINATION WRENCH SET IN POUCH, 14-PCS

ART. NO.	PCS	CONTENTS
41506...22	14	COMBINATION WRENCH 6, 7, 8, 9, 10, 11, 12, 13, 14, 15, 16, 17, 19, 22MM

601702



COMBINATION WRENCH SET IN POUCH, 17-PCS

ART. NO.	PCS	CONTENTS
41506...22	17	COMBINATION WRENCH 6, 7, 8, 9, 10, 11, 12, 13, 14, 15, 16, 17, 18, 19, 20, 21, 22MM

602603



COMBINATION WRENCH SET IN POUCH, 26-PCS

ART. NO.	PCS	CONTENTS
41506...32	26	COMBINATION WRENCH 6, 7, 8, 9, 10, 11, 12, 13, 14, 15, 16, 17, 18, 19, 20, 21, 22, 23, 24, 25, 26, 27, 28, 29, 30, 32MM

601204

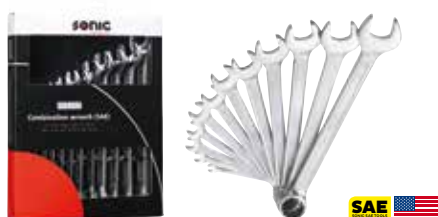

COMBINATION WRENCH SET (SAE) 12-PCS

ART. NO.	PCS	CONTENTS
4150206...24	12	COMBINATION WRENCH 1/4", 5/16", 3/8", 7/16", 1/2", 9/16", 5/8", 11/16", 3/4", 13/16", 7/8", 15/16"

600806



DOUBLE OPEN WRENCH SET (SAE) 8-PCS

ART. NO.	PCS	CONTENTS
4220608...2932	8	DOUBLE OPEN WRENCH 1/4"x5/16", 3/8"x7/16", 1/2"x9/16", 5/8"x11/16", 11/16"x3/4", 13/16"x7/8", 15/16"x1", 1 1/8"x1 1/4"

600701



45° OFFSET RING WRENCH SET (SAE) 7-PCS

ART. NO.	PCS	CONTENTS
4270608...2425	7	45° OFFSET RING WRENCH 1/4"x5/16", 3/8"x7/16", 1/2"x9/16", 9/16"x5/8", 11/16"x3/4", 13/16"x7/8", 15/16"x1"

600402



FLARE NUT WRENCH SET (SAE) 4-PCS

ART. NO.	PCS	CONTENTS
4250608...1617	4	FLARE NUT WRENCH 1/4"x5/16", 3/8"x7/16", 1/2"x9/16", 5/8"x11/16"

600507



FLEXIBLE FLARE NUT WRENCH SET 5-PCS

ART. NO.	PCS	CONTENTS
40808...12	5	FLEXIBLE FLARE NUT WRENCH 8, 9, 10, 11, 12MM

600203



4-IN-1 RATCHETING WRENCH SET IN POUCH 2-PCS

ART. NO.	DESCRIPTION	L(MM)	B1(MM)	B2(MM)	A1(MM)	A2(MM)	G	PCS/BAG
4170401	4-IN-1 RING RATCHET WRENCH 8-10, 12-13	160	21.5	26.5	8.9	9.8	98	5
4170402	4-IN-1 RING RATCHET WRENCH 16-17, 18-19	230	34.5	35.6	11.7	12.2	264	5

601219



REVERSIBLE RATCHETING WRENCH 12PT.IN POUCH, 12-PCS

ART. NO.	PCS	CONTENTS
4170208...19	12	REVERSIBLE RATCHETING WRENCH 12PT. 8, 9, 10, 11, 12, 13, 14, 15, 16, 17, 18, 19MM

601209



FLAT RATCHETING WRENCH 6PT. SET IN POUCH, 12-PCS

ART. NO.	PCS	CONTENTS
4170408...19	12	FLAT RATCHETING WRENCH 6PT. 8, 9, 10, 11, 12, 13, 14, 15, 16, 17, 18, 19MM

601210



FLEXIBLE RATCHETING WRENCH 6PT. SET IN POUCH, 12-PCS

ART. NO.	PCS	CONTENTS
4170608...19	12	FLEXIBLE RATCHETING WRENCH 6PT. 8, 9, 10, 11, 12, 13, 14, 15, 16, 17, 18, 19MM

601223



FLAT RING RATCHETING SET 12PT.IN POUCH, 12-PCS

ART. NO.	PCS	CONTENTS
4170108...19	12	FLAT RATCHETING WRENCH 12PT. 14, 8, 9, 10, 11, 12, 13, 14, 15, 16, 17, 18, 19MM

601218



FLEXIBLE RATCHETING WRENCH 12PT. SET IN POUCH, 12-PCS

ART. NO.	PCS	CONTENTS
4170308...19	12	FLEXIBLE RATCHETING WRENCH 12PT. 8, 9, 10, 11, 12, 13, 14, 15, 16, 17, 18, 19MM

Auto Special Tools

601014



HEXAGON KEY WRENCH SET 3 TIP T-HANDLE 10-PCS

ART. NO.	DESCRIPTION
4840102...10	2, 2.5, 3, 4, 4.5, 5, 6, 7, 8, 10MM

601015



TX KEY SET T-HANDLE 3 TIP 10-PCS

ART. NO.	DESCRIPTION
4840210...55	T10, T15, T20, T25, T27, T30, T40, T45, T50, T55

4560201



COTTER PIN DRIVER FOR BRAKE

- WITH EXTRA-LONG MANDREL, ESPECIALLY FOR BRAKE PINS
- 175MML
- 4MM

4560202



COTTER PIN DRIVER FOR BRAKE

- WITH EXTRA-LONG MANDREL, ESPECIALLY FOR BRAKE PINS
- 175MML
- 6MM

803001



ELECTRICAL CONNECTION CLIP REMOVER 2-PCS

- HANDY TOOLS FOR REMOVING ELECTRICAL CLIPS IN CONFINED OR DIFFICULT AREAS
- CUSHIONED GRIP HANDLES FOR NON-SLIP OPERATION
- HOOK STYLE AND FLAT

ART. NO.	DESCRIPTION
803001-1	CLIP REMOVER HOOK
803001-2	CLIP REMOVER FLAT

600401



MINI HOOK SET 4-PCS

ART. NO.	PCS	CONTENTS
47809	1	MINI STRAIGHT PICK
47810	1	MINI DEGREE HOOK
47811	1	MINI FULL HOOK
47812	1	MINI SMALL ANGLE HOOK

600439



MINI HOOK SET 4-PCS

ART. NO.	PCS	CONTENTS
47829	1	MINI STRAIGHT PICK HOOK
47830	1	MINI DEGREE HOOK
47831	1	MINI FULL HOOK
47832	1	MINI SMALL ANGLE HOOK

600437



HOOK SET 4-PCS

ART. NO.	PCS	CONTENTS
47909	1	STRAIGHT PICK HOOK
47910	1	DEGREE HOOK
47911	1	FULL HOOK
47912	1	SMALL ANGLE HOOK

600403



PRY BAR SET 4-PCS

ART. NO.	PCS	CONTENTS
48203210	1	BENT PRY BAR 8"
48203300	1	BENT FORKED PRY BAR 12"
48203460	1	ELBOW BENT PRY BAR 18"
48203610	1	EXTENDED PRY BAR 24"

600436



PRY BAR SET HEAVY DUTY 4-PCS

ART. NO.	CONTENTS
-	PRYBAR (STRAIGHT) 890MML
-	PRYBAR (45°) 890MML
-	PRYBAR (75°) 635MML
-	PRYBAR (90°) 635MML

805003



INDEXABLE RATCHETING PRY BAR SET 3-PCS

- INDEXABLE RATCHETING PRY BAR ALLOW EASY ACCES INTO AREAS WHICH ARE DIFFICULT TO REACH
- ADJUSTABLE HEAD ALLOW CHOICE OF UP TO 8 DIFFERENT ANGLES
- HIGH LEVERAGE GEAR DESIGN PROVIDES MAXIMUM LEVERAGE WHILE LIFTING AND CUTTING BACK
- FAST AND EASY ADJUSTABLE
- THIN FEET
- FOR USING / DISASSEMBLING: GEARBOX, CILINDERHEAD, WATERPUMP AND OTHER PARTS OF CAR

ART. NO.	DESCRIPTION
805003-1	INDEXABLE RATCHETING PRY BAR 10"
805003-2	INDEXABLE RATCHETING PRY BAR 12"
805003-3	INDEXABLE RATCHETING PRY BAR 15"

600320



SCRAPER SET 3-PCS

ART. NO.	PCS	CONTENTS
47818	1	STICKER SCRAPER
47819	1	SEAL SCRAPER
47820	1	ANGLE SCRAPER

48212...



PRY BAR

ART. NO.	L(MM)	G	PCS/BAG
48212380	380	342	5
48212530	530	928	5
48212650	650	1122	5

803005



PRY REMOVER SET 5-PCS

- EXTRA SLIM AND UNIQUE SHAPE FOR DELICATE JOBS SUCH AS REMOVING SMALL RIVET OR FINE TRIMS, BEZELS OF DASHBOARDS, DOOR PANELS, DOOR LOCKS, ELECTRONIC SEAT CONTROLS, GEAR SHIFTER, INNER LINING, ... ETC.
- MADE OF HIGH QUALITY IMPACT-RESISTANT NYLON MATERIAL - DOES NOT DAMAGE OR SCRATCH THE SURFACE

ART. NO.	PCS	DESCRIPTION
803005-1	1	PRY REMOVER 1
803005-2	1	PRY REMOVER 2
803005-3	1	PRY REMOVER 3
803005-4	1	PRY REMOVER 4
803005-5	1	PRY REMOVER 5

803004



PRY REMOVER SET 11-PCS

- EXTRA SLIM AND UNIQUE SHAPE FOR DELICATE JOBS SUCH AS REMOVING SMALL RIVET OR FINE TRIMS, BEZELS OF DASHBOARDS, DOOR PANELS, DOOR LOCKS, ELECTRONIC SEAT CONTROLS, GEAR SHIFTER, INNER LINING ETC.
- MADE OF HIGH QUALITY IMPACT-RESISTANT NYLON MATERIAL - DOES NOT DAMAGE OR SCRATCH THE SURFACE

ART. NO.	PCS	DESCRIPTION
803004-1	1	PRY REMOVER 1
803004-2	1	PRY REMOVER 2
803004-3	1	PRY REMOVER 3
803004-4	1	PRY REMOVER 4
803004-5	1	PRY REMOVER 5
803004-6	1	PRY REMOVER 6
803004-7	1	PRY REMOVER 7
803004-8	1	PRY REMOVER 8
803004-9	1	PRY REMOVER 9
803004-10	1	PRY REMOVER 10
803004-11	1	PRY REMOVER 11

821001



PRY REMOVAL MASTER KIT 27-PCS

- EXTRA SLIM AND UNIQUE SHAPE FOR DELICATE JOBS SUCH AS REMOVING SMALL RIVET OR FINE TRIMS, BEZELS OF DASHBOARDS, DOOR PANELS, DOOR LOCKS, ELECTRONIC SEAT CONTROLS, GEAR SHIFTER, INNER LINING, ... ETC.
- MADE OF HIGH QUALITY IMPACT-RESISTANT NYLON MATERIAL - DOES NOT DAMAGE OR SCRATCH THE SURFACE

4821301



WEDGE UNIVERSAL

ART. NO.	DESCRIPTION	L(MM)	W(MM)	N.W.(G)	PCS/BAG
4821301	WEDGE UNIVERSAL	190	30	74	1

4821302



WEDGE FELTED SURFACE

ART. NO.	DESCRIPTION	L (MM)	W (MM)	N.W.(G)	PCS/BAG
4821302	WEDGE FELTED SURFACE	250	20	90	1

4821303



WEDGE SPIKY

ART. NO.	DESCRIPTION	L (MM)	W (MM)	N.W.(G)	PCS/BAG
4821303	WEDGE SPIKY	250	20	40	1

4821304



WEDGE UNIVERSAL WIDE

ART. NO.	DESCRIPTION	L (MM)	W (MM)	N.W.(G)	PCS/BAG
4821304	WEDGE UNIVERSAL WIDE	190	60	160	1

4821305



WEDGE SPECIAL LEVEL

ART. NO.	DESCRIPTION	L (MM)	W (MM)	N.W.(G)	PCS/BAG
4821305	WEDGE SPECIAL LEVEL	230	30	94	1

600318



WEDGE UTILITY SET 3-PCS

- UTILITY WEDGE SET SUITABLE FOR REMOVAL OF WIDE RANGE OF EXTERIOR BODY AND INTERIOR TRIMS
- COMPOSITE MATERIAL REDUCES CHANCES OF MARKING OR SCRATCHING PAINTWORK BODY/TRIM
- INCLUDES FORK-ENDED TRIM STUD REMOVAL TOOL

ART. NO.	PCS	CONTENTS
4821301	1	WEDGE UNIVERSAL 190X30MM
4821304	1	WEDGE UNIVERSAL WIDE 190X60MM
4821305	1	WEDGE SPECIAL LEVEL 230X30MM

600506



WEDGE UTILITY SET 5-PCS

- UTILITY WEDGE SET SUITABLE FOR REMOVAL OF WIDE RANGE OF EXTERIOR BODY AND INTERIOR TRIMS
- COMPOSITE MATERIAL REDUCES CHANCES OF MARKING OR SCRATCHING PAINTWORK BODY/TRIM
- INCLUDES FORK-ENDED TRIM STUD REMOVAL TOOL

ART. NO.	PCS	CONTENTS
4821301	1	WEDGE UNIVERSAL 190X30MM
4821302	1	WEDGE FELTED SURFACE 250X20MM
4821303	1	WEDGE SPIKY 250X20MM
4821304	1	WEDGE UNIVERSAL WIDE 190X60MM
4821305	1	WEDGE SPECIAL LEVEL 230X30MM

813001



- RATCHET MECHANISM CRIMPER STANDS FOR SUPERIOR LABOUR SAVING
- QUICK INSERTION CHANGING OF JAW WITHOUT ANY TOOL
- PROFESSIONAL AISI 4140 ALLOY STEEL CRIMPING JAWS
- ERGONOMIC COMFORT-GRIP HANDLE

FEATURES:

- CRIMPING TOOL SET WITH RATCHETING FUNCTION AND ADJUSTABLE JAWS
- INCLUDES 6 EXCHANGEABLE CRIMPING JAWS
- INSULATED TERMINAL ENDS DIN 0.5-6MM²
- NON-INSULATED TERMINAL ENDS DIN 1.5-10MM²
- OPEN BARREL TERMINAL ENDS DIN 0.5-4.0MM²
- INSULATED CORD-END TERMINAL DIN 0.5-6MM² (FOR SMALL SIZES)
- INSULATED CORD-END TERMINAL DIN 0.5-6MM² (FOR LARGE SIZES)
- OPEN BARREL TERMINAL & D-SUB,V3.5

813002



- RATCHET MECHANISM CRIMPER STANDS FOR SUPERIOR LABOUR SAVING
- QUICK INSERTION CHANGING OF JAW WITHOUT ANY TOOL
- PROFESSIONAL AISI 4140 ALLOY STEEL CRIMPING JAWS
- ERGONOMIC COMFORT-GRIP HANDLE

FEATURES:

- CRIMPING TOOL SET WITH RATCHETING FUNCTION AND ADJUSTABLE JAWS
- INCLUDES 10 EXCHANGEABLE CRIMPING JAWS
- INSULATED TERMINAL ENDS DIN 0.5-6MM²
- NON-INSULATED TERMINAL ENDS DIN 1.5-10MM²
- OPEN BARREL TERMINAL ENDS DIN 0.5-4.0MM²
- INSULATED CORD-END TERMINAL DIN 0.5-6MM² (FOR SMALL SIZES)
- INSULATED CORD-END TERMINAL DIN 0.5-6MM² (FOR LARGE SIZES)
- OPEN BARREL TERMINAL & D-SUB,V3.5
- CABLE CONNECTOR (BNC)
- 4P4C CONNECTOR
- 6P6C CONNECTOR
- 8P8C CONNECTOR

08

LOOSE JAWS FOR CRIMPING PLIER

ART. NO.	DESCRIPTION	ART. NO.	DESCRIPTION	
81302	<p>JAW FOR INSULATED TERMINAL SURFACE TREATMENT</p> <ul style="list-style-type: none"> - PROCEDURE: PRECISION AND WAX-LOST CASTING - FINISHED WITH HEAT TREATMENT (HRC 38°-45°) - ZINC PHOSPHATE SURFACE TREATMENT <p>MATERIAL</p> <ul style="list-style-type: none"> - AISI 4140 <p>SUITABLE FOR</p> <ul style="list-style-type: none"> - AWG 22-18/16-14/12-10 - DIN 0.5-1.0/1.5-2.5/4-6MM² 		<p>JAW FOR OPEN BARREL TERMINAL SURFACE TREATMENT</p> <ul style="list-style-type: none"> - PROCEDURE: PRECISION AND WAX-LOST CASTING - FINISHED WITH HEAT TREATMENT (HRC 38°-45°) - ZINC PHOSPHATE SURFACE TREATMENT <p>MATERIAL</p> <ul style="list-style-type: none"> - AISI 4140 <p>SUITABLE FOR</p> <ul style="list-style-type: none"> - AWG 14/22/8 - DIN 2.5/0.5/8-10MM² 	
81303	<p>JAW FOR NON-INSULATED TERMINAL SURFACE TREATMENT</p> <ul style="list-style-type: none"> - PROCEDURE: PRECISION AND WAX-LOST CASTING - FINISHED WITH HEAT TREATMENT (HRC 38°-45°) - ZINC PHOSPHATE SURFACE TREATMENT <p>MATERIAL</p> <ul style="list-style-type: none"> - AISI 4140 <p>SUITABLE FOR</p> <ul style="list-style-type: none"> - AWG 20-18/16-14/12-10/8 - DIN 1.5/2.5/6/10MM² - JIS 1.25/2/5.5/8 MM² 		<p>JAW FOR CABLE CONNECTOR (BNC) SURFACE TREATMENT</p> <ul style="list-style-type: none"> - PROCEDURE: PRECISION AND WAX-LOST CASTING - FINISHED WITH HEAT TREATMENT (HRC 38°-45°) - ZINC PHOSPHATE SURFACE TREATMENT <p>MATERIAL</p> <ul style="list-style-type: none"> - AISI 4140 <p>SUITABLE FOR</p> <ul style="list-style-type: none"> - 0.255"/0.213"/0.100/0.068"/0.24 - 6.48/5.41/2.54/1.72/8.23MM - RG 58/59/62/6 	
81304	<p>JAW FOR OPEN BARREL TERMINAL SURFACE TREATMENT</p> <ul style="list-style-type: none"> - PROCEDURE: PRECISION AND WAX-LOST CASTING - FINISHED WITH HEAT TREATMENT (HRC 38°-45°) - ZINC PHOSPHATE SURFACE TREATMENT <p>MATERIAL</p> <ul style="list-style-type: none"> - AISI 4140 <p>SUITABLE FOR</p> <ul style="list-style-type: none"> - AWG 20-18/16-14/12-10 - DIN 0.5-1.0/1.5-2.5/4-6MM² 		<p>JAW FOR 4P4C CONNECTOR SURFACE TREATMENT</p> <ul style="list-style-type: none"> - PROCEDURE: PRECISION AND WAX-LOST CASTING - FINISHED WITH HEAT TREATMENT (HRC 38°-45°) - ZINC PHOSPHATE SURFACE TREATMENT <p>MATERIAL</p> <ul style="list-style-type: none"> - AISI 4140 <p>SUITABLE FOR</p> <ul style="list-style-type: none"> - 4P4C/RJ22 PLUGS 	
81305	<p>JAW FOR CORD-END TERMINAL (SMALL SIZE) SURFACE TREATMENT</p> <ul style="list-style-type: none"> - PROCEDURE: PRECISION AND WAX-LOST CASTING - FINISHED WITH HEAT TREATMENT (HRC 38°-45°) - ZINC PHOSPHATE SURFACE TREATMENT <p>MATERIAL</p> <ul style="list-style-type: none"> - AISI 4140 <p>SUITABLE FOR</p> <ul style="list-style-type: none"> - AWG 22/20/18/16/14/12 - DIN 0.5/0.75/1.0/1.5/2.5/4.0MM² 		<p>JAW FOR 6P6C CONNECTOR SURFACE TREATMENT</p> <ul style="list-style-type: none"> - PROCEDURE: PRECISION AND WAX-LOST CASTING - FINISHED WITH HEAT TREATMENT (HRC 38°-45°) - ZINC PHOSPHATE SURFACE TREATMENT <p>MATERIAL</p> <ul style="list-style-type: none"> - AISI 4140 <p>SUITABLE FOR</p> <ul style="list-style-type: none"> - 6P2C/6P4C/RJ11 PLUGS - 6P6C/RJ12 PLUGS 	
81306	<p>JAW FOR CORD-END TERMINAL (LARGE SIZE) SURFACE TREATMENT</p> <ul style="list-style-type: none"> - PROCEDURE: PRECISION AND WAX-LOST CASTING - FINISHED WITH HEAT TREATMENT (HRC 38°-45°) - ZINC PHOSPHATE SURFACE TREATMENT <p>MATERIAL</p> <ul style="list-style-type: none"> - AISI 4140 <p>SUITABLE FOR</p> <ul style="list-style-type: none"> - AWG 10/8/6 - DIN 6/10/16MM² 		<p>JAW FOR 8P8C CONNECTOR SURFACE TREATMENT</p> <ul style="list-style-type: none"> - PROCEDURE: PRECISION AND WAX-LOST CASTING - FINISHED WITH HEAT TREATMENT (HRC 38°-45°) - ZINC PHOSPHATE SURFACE TREATMENT <p>MATERIAL</p> <ul style="list-style-type: none"> - AISI 4140 <p>SUITABLE FOR</p> <ul style="list-style-type: none"> - 8P8C/RJ45 PLUGS 	

4822101



13 PCS INSTALL HAMMER SET

ART. NO.	PCS	DESCRIPTION
4822101-1	1	40MM HAMMER
4822101-2	1	40MM BLACK HEAD
4822101-3	1	40MM RED HEAD
4822101-4	1	40MM BRASS HEAD
4822101-5	1	40MM WHITE HEAD
4822101-6	1	40MM KEY
4822101-7	1	30MM HAMMER
4822101-8	1	30MM BLACK HEAD
4822101-9	1	30MM RED HEAD
4822101-10	1	30MM BRASS HEAD
4822101-11	1	30MM WHITE HEAD
4822101-12	1	30MM KEY

482210...



ART. NO.	DESCRIPTION	L(MM)	G	PCS/BAG
4822102	HAMMER	311	472	6
4822103	CHANGEABLE HEAD YELLOW	24	35	1
4822104	CHANGEABLE HEAD WHITE	24	35	1

829007



DOOR LOCK DISMANTLING TOOL - VOLKSWAGEN

ESPECIALLY FOR THE REMOVAL AND INSTALLATION OF THE COVERS OF THE DOOR HANDLES WITHOUT CYLINDER LOCK. THE LOCK IS AT A VERY INACCESSIBLE LOCATION. SUITABLE FOR VOLKSWAGEN FOX FROM 2005, GOLF 6 FROM 2008, PASSAT B6 (3C) FROM 2005, TIGUAN FROM 2008. SUITABLE FOR OEM NUMBER T10389.

600308



HOSE LINE CLAMP SET 3-PCS

3PC HOSE LINE CLAMP SET WITH SPECIAL DESIGNED JAWS TO PREVENT INTERNAL HOSE LININGS FROM DAMAGE. LIGHTWEIGHT, EASY TO USE AND NON CONDUCTIVE.
3 SIZES TO FIT ALL TYPES OF HOSE.
- SMALL CLAMP FOR 1/8" TO 5/16" DIAMETER
- MEDIUM CLAMP FOR 1/2" TO 3/4" DIAMETER
- LARGE SIZE CLAMP FOR 3/4" TO 2-1/2" DIAMETER
- MADE OF HEAT-RESISTANT REINFORCED NYLON
- EACH CLAMP INCLUDES A LOCKING MECHANISM

ART. NO.	DESCRIPTION
600308-1	SMALL CLAMP FOR 1/8" TO 5/16" DIAMETER
600308-2	MEDIUM CLAMP FOR 1/2" TO 3/4" DIAMETER
600308-3	LARGE SIZE CLAMP FOR 3/4" TO 2-1/2" DIAMETER

820012

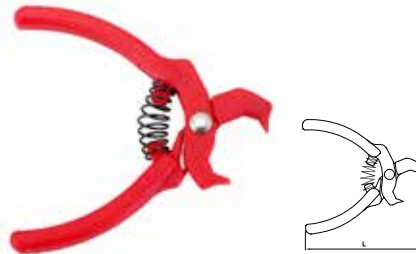

2-PCS MINI TRIM CLIP REMOVAL PLIERS

SET OF TWO PLIERS
- PLIERS 1 FOR CLIPS Ø 0-28MM
- PLIERS 2 FOR CLIPS Ø 0-20MM
- FOR THE REMOVAL OF TWO PIECE PLASTIC CLIPS
- SELF OPENING
- MADE FROM POLYOXYMETHYLENE (POM)

820011



SPARK PLUG WIRE PULLER

- HEAVY DUTY PLASTIC CONSTRUCTION
- INSULATES HANDS FROM ELECTRIC SHOCK
- GRIPS DIRECTLY ON BOOT TO PREVENT WIRE DAMAGE
- MATERIAL: POM

810002



HOSE CLAMP PLIERS SET 7-PCS

ART. NO.	DESCRIPTION
4472100	HOSE CLAMP PLIERS. ALLOWS FOR EXTRA REACH, REMOVAL AND LOCKING OF CLAMPS INTO OPEN POSITION. ALLOWS FOR REMOVAL OF PLASTIC AND/OR METAL SELF-TIGHTENING HOSE CLAMPS WITH DIAMETERS OF 11/16" - 2-1/2" (18MM-54MM). PRECISION CLAMP ON END OF FLEXIBLE CABLE ALLOWS FOR EXTENDED REACH WHERE OTHER MODELS CAN'T REACH. PLIERS CAN BE LOCKED, FREEING UP YOUR HANDS AND MAKING YOUR JOB EASIER AND FASTER. CABLE AND SPRING ARE WEARABLE ITEMS AND MUST BE REPLACED
810002-1	SWIVEL JAW HOSE CLAMP PLIERS ('+' SLOT)
810002-2	SWIVEL JAW HOSE CLAMP PLIERS. SWIVEL JAWS ARE SLOTTED FOR POSITIVE HOLDING OR LARGE OR SMALL CLAMPS AT ANY ANGLE. RATCHET ACTION HOLDS JAWS CLOSED IN 5 DIFFERENT POSITIONS. FITS ALL AUTOMOTIVE AND APPLIANCE SPRING WIRE HOSE CLAMPS. ALLOWS FAST AND EASY CLAMP REMOVAL. PLIERS LATCH IN POSITION TO SECURELY HOLD HOSE CLAMP WHEN EXPANDED.
810002-3	ANGLED FLAT BAND HOSE CLAMP PLIERS. DESIGNED TO REMOVE AND INSTALL FLAT BAND HOSE CLAMPS IN HARD TO REACH AREAS. PLIERS FEATURE ANGLED JAWS WITH 360° ROTATING TIPS TO GRIP CLAMPS AT ANY ANGLE. LOCKING LATCH SECURELY HOLDS CLAMP IN POSITION.
810002-4	FLAT BAND HOSE CLAMP PLIERS. REMOVES AND INSTALLS NEW STYLE FLAT BAND HOSE CLAMPS. JAWS ROTATE 360° TO GRIP AT ANY ANGLE.
810002-5	CLIC-R COLLAR PLIERS. FOR RELEASING AND RE-FITTING REUSABLE HOSE CLIPS. FOR TYPE AND CLIC-R.
810002-6	HOSE REMOVER PLIERS. DESIGNED TO ALLOW EASY REMOVAL OF 5/32" TO 1/2" VACUUM AND FUEL HOSES.

820005



FUEL LINE DISCONNECT SET 3-PCS

ART. NO.	DESCRIPTION
820005-1	RED
820005-2	GREEN
820005-3	BLUE

4472100



FLEXIBLE CABLE HOSE CLAMP REMOVING PLIERS

- FLEXIBLE CLAMP FASTENER
- FLEXIBLE CABLE TO REACH HARD PLACES
- PLIERS LATCH IN POSITION TO SECURELY HOLD HOSE CLAMP WHEN EXPANDED
- ADJUSTABLE CABLE TENSION

812002



DAMPER PULLEY PULLER HOLDER WRENCH SET 5-PCS

ART. NO.	DESCRIPTION
812002-1	DAMPER PULLEY PULLER HOLDER WRENCH 13MM
812002-2	DAMPER PULLEY PULLER HOLDER WRENCH 15MM
812002-3	DAMPER PULLEY PULLER HOLDER WRENCH 16MM
812002-4	DAMPER PULLEY PULLER HOLDER WRENCH 17MM
812002-5	DAMPER PULLEY PULLER HOLDER WRENCH 19MM

805015



15 PCS PULLEY WRENCH SET, 12-19MM, E10-E18

ART. NO.	PCS	DESCRIPTION
805015-1	1	PULLEY WRENCH
805015-2	8	PULLEY WRENCH HEAD 12, 13, 14, 15, 16, 17, 18, 19MM
805015-10	5	PULLEY WRENCH HEAD E10, E12, E14, E16, E18

4831201



CROSS RIM WRENCH

- LENGTH 355MM
- SIZES 17, 19, 22MM
- SIZE 13/16"

829110



BRAKE BLEEDER WRENCH SET 6PT 5-PCS

- BUILT IN SOCKET (6 POINT) AND WRENCH
- SOCKET SIZES 8, 9, 10, 11, 12MM
- 1.2M SILICON HOSE WITH CHECK VALVE
- IDEAL FOR BLEEDING BRAKE AND HYDRAULIC CLUTCH SYSTEMS

300301



WHEEL SOCKET SET 1/2", 3-PCS

ART. NO.	PCS	CONTENTS
3310117...21	3	1/2" WHEEL SOCKET 17, 19, 21MM

⚠️ ONLY USE WITH TORQUE WRENCHES, MAX TO 100NM

300310



WHEEL SOCKET SET, EXTRA LONG 1/2", 3-PCS

IMPACT-PROOF, FULLY ENCAPSULATED IN PLASTIC. EXTRA THIN WALLS, OPTIMUM FORCE TRANSMISSION, RIMS AND BOLTS NO LONGER BECOME SCRATCHED, WITH GROOVE AND BORE HOLE. SPECIAL LENGTH, ESPECIALLY SUITABLE FOR DROP CENTRE RIMS. ANY FALSIFICATION OF TORQUE CAUSED BY PUTTING EXTENSIONS TOGETHER IS AVOIDED.

ART. NO.	PCS	CONTENTS
3310517...21	3	1/2" WHEEL SOCKET 150L 17, 19, 21MM

300302



IMPACT SOCKET SET 1/2", 3-PCS

- SOCKET 17, 19, 21MM
- THIN WALL
- PLASTIC STOP
- LENGTH 105MM

300506



WHEEL SOCKET SET 1/2", 5-PCS

ART. NO.	PCS	CONTENTS
3310115...22	5	WHEEL SOCKET 1/2", 15, 17, 19, 21, 22MM

300304



TORQUE IMPACT ADAPTOR SET 1/2", 3-PCS

- 3/8", 1/2", 3/4"
- UP TO 100NM
- LENGTH 100MM(L)
- SET TO LOOSEN THE LUG NUTS WITH FULL TORQUE DELIVERY OF IMPACT WRENCH
- PATENTED DESIGN FOR FASTENED THE LUG NUTS QUICKLY AND ACCURATELY TO REACH PRESETTING TORQUE STRENGTH. THE TORQUE SOCKET WILL FREE RUNNING AUTOMATICALLY WHEN REACH THE PRESETTING TORQUE.
- CHECK THE TORQUE STRENGTH BY TORQUE WRENCH, ACCORDING TO THE MAINTENANCE MANUAL OF DIFFERENT VEHICLES. TO ENSURE THE NUTS FASTENED SECURELY WITH CORRECT TORQUE STRENGTH.

⚠️ WARNING THIS PRODUCT IS DESIGNED FOR SAFETY. BECAUSE THE TIGHTENING TORQUE IS ALWAYS LOWER THAN THE SAFETY VALUE. (THE PRESET TORQUE WILL DECREASE GRADUALLY AND FINALLY STABLE AT ABOUT 25-35 NM.) MUST USE TORQUE WRENCH FOR FINAL TIGHTENING.

ART. NO.	DESCRIPTION
300304-1	3/8" TORQUE LIMITED IMPACT ADAPTOR
300304-2	1/2" TORQUE LIMITED IMPACT ADAPTOR
300304-3	3/4" TORQUE LIMITED IMPACT ADAPTOR

300303



TORQUE IMPACT SOCKET SET 1/2", 3-PCS

- SOCKETS 17, 19, 21MM
- UP TO 100NM
- LENGTH 100MM(L)
- SET TO LOOSEN THE LUG NUTS WITH FULL TORQUE DELIVERY OF IMPACT WRENCH
- PATENTED DESIGN FOR FASTENED THE LUG NUTS QUICKLY AND ACCURATELY TO REACH PRESETTING TORQUE STRENGTH. THE TORQUE SOCKET WILL FREE RUNNING AUTOMATICALLY WHEN REACH THE PRESETTING TORQUE.
- CHECK THE TORQUE STRENGTH BY TORQUE WRENCH, ACCORDING TO THE MAINTENANCE MANUAL OF DIFFERENT VEHICLES. TO ENSURE THE NUTS FASTENED SECURELY WITH CORRECT TORQUE STRENGTH.

⚠ WARNING THIS PRODUCT IS DESIGNED FOR SAFETY. BECAUSE THE TIGHTENING TORQUE IS ALWAYS LOWER THAN THE SAFETY VALUE. (THE PRESET TORQUE WILL DECREASE GRADUALLY AND FINALLY STABLE AT ABOUT 25-35 NM.) MUST USE TORQUE WRENCH FOR FINAL TIGHTENING.

300307



ROTATING EXTENSION SET, 3-PCS

ART. NO.	DESCRIPTION
300307-1	1/4"DR. ROTATING EXTENSION 100MML
300307-2	3/8"DR. ROTATING EXTENSION 150MML
300307-3	1/2"DR. ROTATING EXTENSION 250MML

7150310



GLOWPLUG JOINT 3/8", SOCKET, 10MM

FOR GLOW PLUGS (TDI + CDI) THAT ARE DIFFICULT TO REACH 10MM, 140MML

805001



GLOW PLUG SOCKET SET 3/8", 3-PCS

- THESE SOCKETS HAVE A UNIVERSAL JOINT FOR EASY REPLACEMENT AND REMOVAL OF POPULAR SIZED GLOW PLUGS
- MANUFACTURED FROM MATT FINISHED CHROME VANADIUM
- SUPPLIED IN BLOW MOULD CASE FOR STORAGE

SIZE

8,10,12MM X 72MML

300402



TWIST SOCKET SET 1/2", 4-PCS

- FOR REMOVING DAMAGED WHEEL NUTS AND LOCKING NITS ESPECIALLY USEFUL ON DEEP SEATED WHEEL NUTS ON MODERN ALLOYS
- FEATURES HOLLOW CONSTRUCTION TO ALLOW THE NUT TO BE EXTRACTED FROM THE SOCKET
- STRAIGHT ROD FOR REMOVING THE NUT

SIZE

- SIZES 17, 19, 21MM
- BAR 160MML

300504



SPIRAL SOCKET SET 1/2", 5-PCS

- REMOVES ROUNDED/DAMAGED NUTS AND BOLTS
- MANUFACTURED FROM CHROME MOLYBDENUM FOR STRENGTH

ART. NO.	DESCRIPTION
300504-1	1/2" SPIRAL SOCKET 17MM
300504-2	1/2" SPIRAL SOCKET 19MM
300504-3	1/2" SPIRAL SOCKET 21MM
300504-4	1/2" SPIRAL SOCKET 23MM
300504-5	1/2" SPIRAL SOCKET 27MM
300504-6	BAR 50MML

300901



SPIRAL SOCKET SET 3/8", 10-PCS

- REMOVES ROUNDED/DAMAGED NUTS AND BOLTS
- MANUFACTURED FROM CHROME MOLYBDENUM FOR STRENGTH

ART. NO.	DESCRIPTION
300901-1...9	3/8" SPIRAL SOCKET 10, 11, 12, 13, 14, 15, 16, 17, 19MM
300901-10	BAR 50MML

818026



SPIRAL SOCKET SET 1/4" & 1/2", 15-PCS

- REMOVES ROUNDED/DAMAGED NUTS AND BOLTS
- MANUFACTURED FROM CHROME MOLYBDENUM FOR STRENGTH

ART. NO.	PCS	CONTENTS
818026-1	1	PIN BAR (SMALL)
818026-2	1	PIN BAR (LARGE)
818026-6	1	TWIST SOCKET 1/4" 6MM
818026-8	1	TWIST SOCKET 1/4" 8MM
818026-10	1	TWIST SOCKET 1/4" 10MM
818026-11	1	TWIST SOCKET 1/4" 11MM
818026-12	1	TWIST SOCKET 1/4" 12MM
818026-13	1	TWIST SOCKET 1/4" 13MM
818026-14	1	TWIST SOCKET 1/4" 14MM
818026-15	1	TWIST SOCKET 1/4" 15MM
818026-17	1	TWIST SOCKET 1/4" 17MM
818026-19	1	TWIST SOCKET 1/4" 19MM
818026-21	1	TWIST SOCKET 1/4" 21MM

818030



WHEEL LUG NUT SET, 10-PCS

ART. NO.	DESCRIPTION
818030-1	PIN BAR (SMALL)
818030-2	PIN BAR (LARGE)
818030-3	WHEEL LUG NUT A30.9
818030-4	WHEEL LUG NUT A30.0
818030-5	WHEEL LUG NUT A31.8
818030-6	WHEEL LUG NUT A28.9
818030-7	WHEEL LUG NUT A28.0
818030-8	WHEEL LUG NUT A27.0
818030-9	WHEEL LUG NUT A26.0
818030-10	WHEEL LUG NUT A23.8

801206

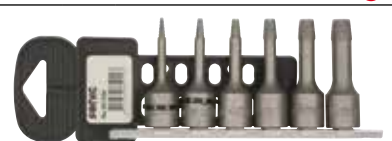

BOLT TWISTER SOCKET SET 3/8", 6-PCS

- EXTRACTS THE JAMMED OR FRACTURED SCREW HEAD CAUSED BY OVER-POWERED, BAD QUALITY OR WEARING-OUT

ART. NO.	PCS	CONTENTS
801206-1	1	3/8" BOLT TWISTER SOCKET 2MM
801206-2	1	3/8" BOLT TWISTER SOCKET 3MM
801206-3	1	3/8" BOLT TWISTER SOCKET 4MM
801206-4	1	3/8" BOLT TWISTER SOCKET 6MM
801206-5	1	3/8" BOLT TWISTER SOCKET 8MM
801206-6	1	3/8" BOLT TWISTER SOCKET 10MM

829006

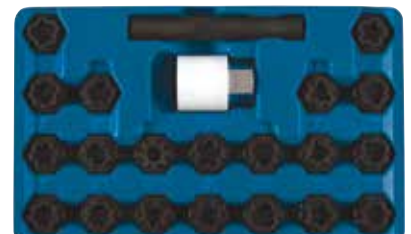

WHEEL NUT KEY SET - AUDI 22-PCS

829111



WHEEL HANGER SET 5-PCS

- WHEELS BECOMING LARGER AND MORE UNWIELDY, THESE WHEEL HANGER PINS SIMPLIFY THE WHEEL
- INSTALLATION PROCESS BY HOLDING THE RIM CENTRED ON THE HUB AS YOU HAND SCREW IN THE WHEEL BOLTS
- IDEAL WHEN FITTING WHEEL SPACERS: ALIGNS THE BOLT HOLES, SPACER AND WHEEL TOGETHER
- PARTICULARLY USEFUL WHEN REPLACING THE BRAKE DISCS - THE WHEEL HANGER PIN ENSURES THAT THE HOLES IN THE NEW DISC ARE PERFECTLY ALIGNED WITH THE HOLES IN THE WHEEL HUB. THEN THE DISC SECURING SCREWS CAN BE FITTED WITH THE WHEEL HANGER PIN IN PLACE
- THE FOUR MOST COMMON THREAD AND PITCH SIZES ARE INCLUDED PLUS WHEEL STUD VERSION FOR HUBS WITH WHEEL STUDS

CONTENTS:

- M12X1.5
- M14X1.25
- M14X1.5
- M16X1.5
- M12X1.25 (WHEEL STUD VERSION)

801305



BOLT TWISTER SOCKET SET 1/2", 5-PCS

EXTRACTS THE JAMMED OR FRACTURED SCREW HEAD CAUSED BY OVER-POWERED, BAD QUALITY OR WEARING-OUT

ART. NO.	PCS	DESCRIPTION
801305-1	1	1/2" BOLT TWISTER SOCKET 8MM
801305-2	1	1/2" BOLT TWISTER SOCKET 10MM
801305-3	1	1/2" BOLT TWISTER SOCKET 12MM
801305-4	1	1/2" BOLT TWISTER SOCKET 14MM
801305-5	1	1/2" BOLT TWISTER SOCKET 16MM

829004



WHEEL NUT LOCK SET - VAG 23-PCS

23-PCS VOLKSWAGEN SET, INCLUDING 17 MM WHEEL SOCKET WITH 1/2" CONNECTION. THIS KIT IS DESIGNED FOR THE REMOVAL OF LOCKING BOLTS WHEN THE CUSTOMER HAS FORGOTTEN TO PROVIDE THE ADAPTER BY CAR. THIS IS HAPPENING VERY OFTEN WHEN THE VEHICLE IS BROUGHT TO MAINTENANCE AND / OR REPAIR.
SIZES: 6 - 7 - 8 - 9 - 10 - 11 - 12 - 13 - 14 - 15 - 16 - 17 AND 0/10 - 1/11 - 2/13 - 3/14 - 4/15 - 5/16 - 6/17 - 7/19 - 8/20 - 9/21. FOR VOLKSWAGEN FROM 2010: BEETLE, GOLF, JETTA, PASSAT, POLO, SCIROCCO, SHARAN, TOURAN AND TIGUAN. SUITABLE FOR OEM NUMBERS T10101, T40004.

100301



ADAPTORS FOR DRILLS, 1/4"DR, 3-PCS

ART. NO	PCS	CONTENTS
100301-1	1	1/4" ADAPTER FÜR BOHRMASCHINEN
100301-2	1	3/8" ADAPTER FÜR BOHRMASCHINEN
100301-3	1	1/2" ADAPTER FÜR BOHRMASCHINEN

802214



DRAIN PLUG KEY SET 3/8", 14-PCS

ART. NO.	PCS	DESCRIPTION
802214-1	1	HEX 8MM
802214-2	1	HEX 9MM
802214-3	1	HEX 10MM
802214-4	1	HEX 12MM
802214-5	1	HEX 14MM
802214-6	1	HEX 17MM
802214-7	1	SQUARE 7MM
802214-8	1	SQUARE 8MM
802214-9	1	SQUARE 11MM
802214-10	1	SQUARE 13MM
802214-11	1	SQUARE 3/8"
802214-12	1	SQUARE 5/16"
802214-13	1	10MM SQUARE (FEMALE)
802214-14	1	TRIANGULAR

302001



OIL DRAIN SET 1/2", 20-PCS

METAL BAND FILTER WRENCH 60-120 DIAMETER

SIZE	VEHICLE
OIL FILTER WRENCH	-
3/8"DR EXTENSION 250MML	-
ADAPTOR FOR EXTENSION	-
7MM SQUARE	-
8MM SQUARE	CITROEN, PEUGEOT, RENAULT, TALBOT, VOLVO
10MM SQUARE	-
11MM SQUARE	FORD
12MM SQUARE	-
13MM SQUARE	NISSAN, SUBARU
14MM SQUARE	-
5/16" SQUARE	-
3/8" SQUARE	HONDA, MAZDA, RENAULT, SAAB, VOLVO
10MM SQUARE(FEMALE)	-
10MM TRIANGGULAR	RENAULT
8MM HEX	BMW, FORD, GM
9MM HEX	GM
10MM HEX	FORD
12MM HEX	FIAT, LANCIA, PEUGEOT
14MM HEX	LANCIA, MERCEDES
17MM HEX	AUDI, VW, BMW, AUSTIN

829008



SUMP PLUG REMOVAL TOOL - VAG

FOR PLASTIC DRAIN PLUGS WITH OEM NUMBER 06L-103-801 VAG 4-CYLINDER 2.0 TDI ENGINE OF THE THIRD GENERATION. THE DRAIN PLUG HAS A SPECIAL CONNECTION, FOR WHICH A SPECIAL BIT IS NEEDED. THIS 1/4" BIT HAS GOT A HEXAGON DRIVE AS PER DIN 3126 / ISO 1173 C 6.3. APPLICABLE FOR: AUDI, SEAT LEON, VOLKSWAGEN GOLF 7 FROM 2013. SUITABLE FOR OEM NUMBER T10549. PAY ATTENTION: WHEN INSERTING THE SCREW AGAIN ALWAYS USE A NEW O-RING.

829009



FUEL SENDER/PUMP CLAMPING RING REMOVAL TOOL VAG

FOR THE ASSEMBLY AND DISASSEMBLY OF THE TANK FLOAT WITH MOST VOLKSWAGEN AND AUDI MODELS. INNER DIAMETER 120MM. WITH 1/2" CONNECTION. FOR MODELS FROM 2000 AT AUDI A3 A4 A6 A7 A8 Q3 Q5 Q7 R8 TT AND VOLKSWAGEN BEETLE, CADDY, EOS, GOLF, GOLF CABRIO, GOLF PLUS, JETTA, PASSAT, PASSAT CC, PHAETON, POLO, SHARAN, SCIROCCO, TIGUAN, TOURAN, TRANSPORTER INCLUDING UTILITY VEHICLES. SUITABLE FOR OEM NUMBER T10202 (VAG 3087).

806001



ALTERNATOR TOOLS 13-PCS

REMOVES AND INSTALLS PRESS-ON-TYPE BELT DRIVE ACCESSORY PULLEYS WORKS WITH HAND TOOLS OR AN IMPACT GUN INTER-CHANGEABLE COMPONENTS TO WORK ON VW, AUDI, SEAT, MERCEDES, RENAULT, BMW, FIAT, ETC....

ART. NO.	DESCRIPTION
806001-1	COMBINED SOCKET FOR ALTERNATOR T50X113MML
806001-2	COMBINED SOCKET FOR ALTERNATOR M10X113MML
806001-3	TEETH SOCKET 15MM HEX X 33 TEETH
806001-4	TEETH SOCKET 22MM HEX X 33 TEETH
806001-5	22MM HEX SOCKET
806001-6	35MM ROUND SOCKET
806001-7	1/2" SQ.(F) X 10MM HEX.(F) BITS ADAPTOR
806001-8	10MM(HEX SHANK) X 75MML CR-V BIT T40
806001-9	10MM(HEX SHANK) X 75MML CR-V BIT T50
806001-10	10MM(HEX SHANK) X 75MML CR-V BIT M8
806001-11	10MM(HEX SHANK) X 75MML CR-V BIT M10
806001-12	10MM(HEX SHANK) X 75MML CR-V BIT HEX8
806001-13	10MM(HEX SHANK) X 75MML CR-V BIT HEX10

817006



ALTERNATOR BIT SOCKET 1/2", T50X110L

FOR MOUNTING FREEWHEEL BELT PULLEY. THE BELT PULLEY IS HELD BY 33 TOOTH-INSERT



817007

ALTERNATOR BIT SOCKET, 1/2", M10X110L
FOR MOUNTING FREEWHEEL BELT PULLEY. THE BELT PULLEY IS HELD BY 33 TOOTH-INSERT



83805517

BIT SOCKET XZN 1/2", M17 55MML
- M17
- 55MML
- FOR CYLINDER HEAD SCREWS MERCEDES-BENZ M400, M420, M500 ENGINES

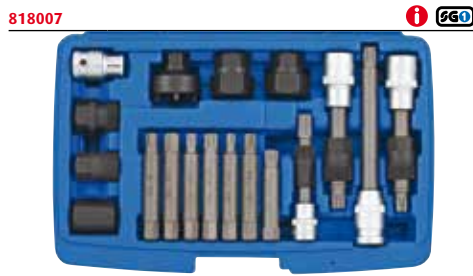

818007

ALTERNATOR PULLEY SET 18-PCS
A COMPREHENSIVE RANGE OF COMBINATION SOCKETS REQUIRED ON THE FREE WHEEL PULLEY WHEN REMOVING OR REPLACING THE ALTERNATOR. THE SET INCLUDES TOOLS FOR BOSCH, MARELLI AND VALEO ALTERNATORS AND IS NOW COMPLETE WITH THE NEW TOOLS REQUIRED FOR THE LATEST RENAULT AND FIAT ALTERNATORS.

ART. NO.	DESCRIPTION
818007-1	COMBINED SOCKET FOR ALTERNATOR T50X113MML
818007-2	COMBINED SOCKET FOR ALTERNATOR M10X113MML
818007-3	33 TEETH CAN IN 15MM HEX
818007-4	33 TEETH CAP IN 22MM
818007-5	22MM HEX
818007-6	35MM CIRCULAR
818007-7	1/2" DR BIT SOCKET
818007-8	10MM(HEX SHANK) X 75MML CR-V BIT T40
818007-9	10MM(HEX SHANK) X 75MML CR-V BIT T50
818007-10	10MM(HEX SHANK) X 75MML CR-V BIT M8
818007-11	10MM(HEX SHANK) X 75MML CR-V BIT M10
818007-12	10MM(HEX SHANK) X 75MML CR-V BIT HEX8
818007-13	10MM(HEX SHANK) X 75MML CR-V BIT HEX10
818007-14	110LXM10 BIT
818007-15	H28XH21 BIT
818007-16	64LXM10 BIT
818007-17	HEXAGONAL NUT 28H X H19 X 35MML
818007-18	3/8" DR. 90MMLXM10 BIT SOCKET

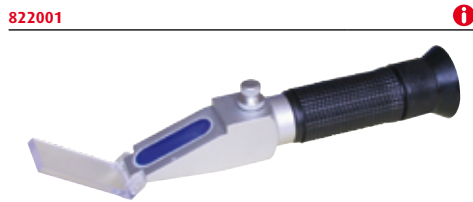

822001

ABDBLE REFRACTOMETER
THIS OPTICAL REFRACTOMETER IS DESIGNED FOR CHECKING THE CONCENTRATION OF ANTIFREEZE AND BATTERY ACID BUT ALSO ABDBLE.
- DESIGNED FOR CHECKING THE CONCENTRATION OF ABDBLE.
- UREA ADDITIVE IN THE EXHAUST FLOW WHICH REDUCES NOX-EMISSIONS.

CONTENTS	
STYLE	BATTERY /COOLANTS/ABDBLE
RANGE	-60°F ~ 32°F / 1.15 ~ 1.30SG
RESOLUTION	10°F; 0.015G
ABDBLE	30%~35%
ETHYLENE GLYCOL	-50°C~0°C
PROPYLENE GLYCOL	-40°C~0°C
CLEANING FLUIDS	-40°C~0°C
BATTERY FLUIDS	1.100-1.400SG
RESOLUTION FACTOR	0.5% 5°C,5°C,5°C,0.015G
SIZE	27 X 40 X 160MM
WEIGHT	176G

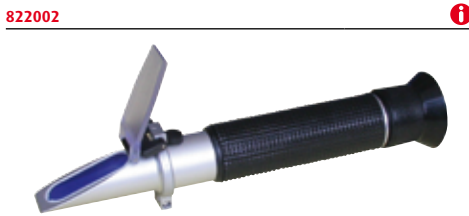

822002

REFRACTOMETER
THIS OPTICAL REFRACTOMETER IS DESIGNED FOR CHECKING THE CONCENTRATION OF ANTIFREEZE AND BATTERY ACID.

CONTENTS	
STYLE	BATTERY /COOLANTS
RANGE	-60°F ~ 32°F / 1.15 ~ 1.30SG
RESOLUTION	10°F; 0.015G
ETHYLENE GLYCOL	-70°C~0°C (-90°F~32°F)
PROPYLENE GLYCOL	-60°C~0°C (-70°F~32°F)
BATTERY FLUIDS	1.100-1.400SG
SIZE	27 X 40 X 160MM
WEIGHT	176G



805016

OIL STOPPER SET, 5-PCS
PREVENTS THE LEAKAGE OF LIQUIDS AT BRAKE, FUEL, AND POWER STEERING LINES OF THE INGRESSION OF SOILING AT AIR-CONDITIONING SYSTEMS

ART. NO.	PCS	DESCRIPTION
805016-1	1	LOCKING PLIERS FOR BANJO BOLT CONNECTION
805016-2	1	LOCKING PLIERS FOR BANJO PIPE CONNECTION
805016-3	1	LOCKING PLUGS FOR INNER DIAMETER 5MM
805016-4	1	LOCKING PLUGS FOR INNER DIAMETER 6.3MM
805016-5	1	LOCKING PLUGS FOR INNER DIAMETER 8MM



828001

45-PCS TYRE REPAIR TOOLS KITS

ART. NO.	DESCRIPTION
828001-1	TYRE REPAIR PLUGS
828001-2	TYRE REPAIR LUBRICANT
828001-3	T-HANDLE INSERT TOOL
828001-4	T-HANDLE SPIRAL PROBE
828001-5	3MM HEX WRENCH



810004

TYRE VALVE DRIVER 2-PCS
WITH TORQUE LIMITATION. THIS ENSURES A RELIABLE FIT AND PREVENTS SENSITIVE VALVES BEING OVER WOUND
- INSERTING TOOL WITH 0.25 NM FOR RUBBER VALVES
- INSERTING TOOL WITH 0.45 NM FOR METAL VALVES



47826

TYRE VALVE DRIVER 0.25NM



47827

TYRE VALVE DRIVER 0.45NM

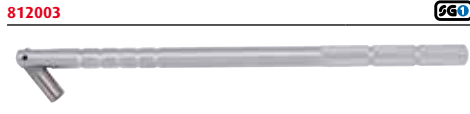

812003

TYRE VALVE STEM FITTING TOOL
FOR FITTING NEW VALVES IN THE RIM VALVE HOLE ON TUBELESS TYRES. 310MML



810003

AIR BAG REMOVAL TOOL SET 12-PCS
APPLICATION
A 12-PCS TOOL KIT FOR REMOVING AIR BAGS ON VOLKSWAGEN, AUDI, SEAT, SKODA, BMW AND MERCEDES.
VW PASSAT B5, POLO, LUPO, AUDI A4 AND A6, SKODA SUBERB
VW GOLF 4, NEW BEETLE, SEAT, SKODA FABIA, OCTAVIA FROM BUILDING YEAR 1999
VW GOLF 4 (BJ. 1998-2004) VW PASSAT FROM BUILDING YEAR 1997, VW BORA FROM BUILDING YEAR 1999
VW MODELL, PASSAT FROM BUILDING YEAR 2000
T30 FOR AUDI, OPEL, RENAULT, VW
T30H FOR AUDI, BMW, MERCEDES, OPEL
T25 FOR BMW
T25H FOR BMW
5MM HEXAGON, FOR AUDI



47023

BRAKE FLUID TESTER
THIS TESTER CAN BE USED AS A DIGITAL BRAKE FLUID TESTER SUITABLE FOR DETERMINING BRAKE FLUID QUALITY. DEVELOPED FOR PROFESSIONAL USE IN AUTOMOTIVE REPAIR SHOPS AND IN SERVICING.

ART. NO.	DESCRIPTION	L (MM)	N.W.(G)	PCS/BAG
47023	BRAKE FLUID TESTER	50	52	1



4830801

3 JAW OIL FILTER WRENCH
- GEAR-DRIVEN AND HEAT-TREATED LEGS WILL HANDLE HIGH TORQUE APPLICATIONS
- REMOVES FILTERS FROM 2-1/2" TO 4" DIAMETER (63-102MM)
- USE 1/2" OR 3/8" SQUARE DRIVE RATCHET 13/16" (21MM) WRENCH

4830802



THREE-LEG OIL FILTER WRENCH (65-120MM)

- REMOVES OIL FILTERS FROM 2 1/2" - 4 3/4" DIAMETER (63,5-12,6MM)
- USE 1/2" OR 3/8" SQUARE DRIVE TOOL OR 21MM (13/16") WRENCH

4831302



OIL FILTER WRENCH CLAW, AUTO ADJUST

812007



OIL FILTER CAP 14 PT. 74MM

ART. NO.	L(MM)	G	PCS/BAG
812007	85	166	1

811003



OIL FILTER CARTRIDGE INSERT

ART. NO.	SIZE	L(MM)	G	PCS/BAG
811003-27	27	38	106	1
811003-32	32	44	144	1
811003-36	36	50	172	1

803003



OIL FILTER CUP SET 15-PCS

- MADE OF GAUGE CONSTRUCTION
- ABLE TO WITHSTAND UP TO 85FT. LBS OF TORQUE
- CUP-TYPE DESIGN GRIPS LIKE A SOCKET MINIMIZING THE POSSIBILITY OF CRUSE HUNG FILTERS
- FITS ADAPTOR 1/2" (F) OF 3/8" (M) DRIVE TOOL
- COATED WITH ELECTRO-BLACK OXIDE FINISH FOR PROTECTION AGAINST RUST
- SUITABLE FOR CANISTER FILTERS

ART. NO.	FLUTE SIZE	APPLICATION
803003-2	65MM X 14	NISSAN, FIAT, HASTING, GM/AC, WIX, NAPA, PUROLATOR, DAIHATSU, TOYOTA
803003-3	68MM X 14	HASTINGS, MAZDA, FORD, SUBARU
803003-4	73MM X 14	TOYOTA, LEXUS
803003-5	74-76MM X 15	FORD, OPEL, VW, AUDI, MERCEDES, FRAM, AC
803003-7	76MM X 14	AUDI, OPEL, CHAMPION, PUROLATOR, MOPAR, VW, PORSCHE, MERCEDES, BMW
803003-10	80MM X 15	OPEL, HASTINGS, FRAM, PUROLATOR, NISSAN, HONDA, MOTORCRAFT, ISUZU, MAZDA, SUBARU
803003-12	93MM X 15	MAZDA, VOLVO, MITSUBISHI, HONDA, CASITE, CHAMP, CHAMPION, GM, FRAM, HASTINGS, PUROLATOR, WIX, NISSAN, VW, PORSCHE, RENAULT
803003-13	93MM X 36	FORD, MOTORCRAFT
803003-1	65-67MM X 14	DAIHATSU, TOYOTA
803003-9	80-82MM X 15	WIX, MAZDA, SUBARU, TOYOTA, HONDA, ACURA, NISSAN
803003-11	90MM X 15	HONDA, MITSUBISHI, MOPAR, ISUZU
803003-6	75-77MM X 15	VW, AUDI, MERCEDES OPEL, CASTITE, GM/AC, HASTINGS, WIX, FORD, ISUZU
803003-8	76MM X 30	MOTORCRAFT
803003-14	100MM X 15	FRAM, MOTORCRAFT, WIX, ISUZU, MITSUBISHI
803003-15	9.5MM	ADAPTOR 1/2" (F) OF 3/8" (M) DRIVE TOOL

i

811002



OIL FILTER CAP SET 30-PCS

- MADE OF GAUGE CONSTRUCTION
- ABLE TO WITHSTAND UP TO 85FT. LBS OF TORQUE
- CUP-TYPE DESIGN GRIPS LIKE A SOCKET MINIMIZING THE POSSIBILITY OF CRUSE HUNG FILTERS
- FITS ADAPTOR 1/2" (F) OF 3/8" (M) DRIVE TOOL
- COATED WITH ELECTRO-BLACK OXIDE FINISH FOR PROTECTION AGAINST RUST
- SUITABLE FOR CANISTER FILTERS

ART. NO.	FLUTE SIZE	APPLICATION
811002-1	66MM X 6	FIAT, RENAULT
811002-2	65MM X 14	DAIHATSU, TOYOTA, NISSAN, FIAT
811002-3	65-67MM X 14	DAIHATSU, TOYOTA
811002-4	68MM X 14	MAZDA, FORD, SUBARU
811002-5	73MM X 14	TOYOTA, LEXUS
811002-6	74MM X 15	AUDI, ROVER, CHRYSLER
811002-7	74-76MM X 15	FORD, OPEL, VW, AUDI, MERCEDES
811002-8	75-77MM X 15	VW, AUDI, ISUZU, MERCEDES
811002-9	76MM X 12	FIAT, MERCEDES, RENAULT
811002-10	76MM X 14	VW, PORSCHE, MERCEDES, BMW, AUDI, OPEL
811002-11	76MM X 30	FORD
811002-12	76MM X 8	FIAT, LANCIA
811002-13	78MM X 15	NISSAN, FORD, TOYOTA
811002-14	80MM X 15	NISSAN, HONDA, OPEL, MAZDA
811002-15	80-82MM X 15	SUBARU, TOYOTA, HONDA, NISSAN
811002-16	86MM X 16	VOLVO
811002-17	86MM X 18	VW, AUDI, PEUGEOT, CITROEN
811002-18	90MM X 15	HONDA, MITSUBISHI, ISUZU
811002-19	92MM X 10	FIAT
811002-20	93MM X 15	MAZDA, VOLVO, MITSUBISHI, NISSAN, HONDA
811002-21	93MM X 36	FORD
811002-22	93MM X 45	VW, AUDI
811002-23	95MM X 15	TOYOTA, ALFA, FORD
811002-24	96MM X 18	AUDI, VW, RENAULT
811002-25	100MM X 15	ISUZU, MITSUBISHI
811002-26	106MM X 15	FIAT
811002-27	108MM X 15	VOLVO
811002-28	108MM X 18	RENAULT
811002-29	ADAPTOR	ADAPTOR 1/2" (F) X 3/8" (M)

08

801003



OIL DRAIN REPAIR KIT

SOLID AND FAST SOLUTION FOR THE REPAIRATION OF DEFECT THREADS AT THE OIL PAN. BY DRILLING OUT AND USING A LARGER DRAIN PLUG A SOLID REPAIRATION IS GRANTED. UNIVERSALLY USABLE FOR AUDI, BMW, CITROEN, DAIMLER, FORD, FIAT, HONDA, MAZDA, MITSUBISHI, NISSAN, OPEL, PEUGEOT, PORSCHE, RENAULT, SAAB, SEAT, SKODA, TOYOTA, VOLVO, VW.

ART. NO.	DESCRIPTION
801003-1	THREAD CUTTER M13X1,5
801003-2	THREAD CUTTER M15X1,5
801003-3	THREAD CUTTER M17X1,5
801003-4	THREAD CUTTER M20X1,5
801003-5	OIL DRAIN PLUGS M13X1,5
801003-6	OIL DRAIN PLUGS M15X1,5
801003-7	OIL DRAIN PLUGS M17X1,5
801003-8	OIL DRAIN PLUGS M20X1,5
801003-9	ALUMINIUM SEALING RING 17
801003-10	ALUMINIUM SEALING RING 19
801003-11	ALUMINIUM SEALING RING 8
801003-12	ALUMINIUM SEALING RING 10

829001



BRAKE ADAPTOR SET - ADJUSTABLE

801016



BRAKE CALIPER SERVICE SET, PNEUMATIC 16-PCS

PNEUMATIC REWIND TOOL FOR LEFT AND RIGHT HAND THREADED PISTONS AND 15 ADAPTORS

ART. NO.	DESCRIPTION	SUITABLE FOR
801016-1	0 DISC	GM MOST 2-1/2" DIAMETER PISTONS
801016-2	2 DISC	CITROEN XM, XANTIA; HONDA
801016-3	3 DISC	AUDI (F); FIAT; ALFA ROMEO(F); FORD FIESTA(F); ISUZU(F); HONDA CONQUESTO(F); JAGUAR XJ6, XJ40(F/R); BMW 318IS, 320I, 325TD, 518I, 525I, 850CI, M5(F); MERCEDES BENZ 190, 200, 300, 420, 560 SERIES (F); MITSUBISHI COLT(F); NISSAN MICRA, STANZA, SUNNY(F); ROVER AUSTIN, METRO 200 & 400 SERIES, MAESTA, MONTEGO; TOYOTA CAMRY(F); VOLVO(F); VW PASSAT, GOLF GTI(F)
801016-4	4 DISC	FORD AUSTRALIA, NZ TELSTAR; MAZDA(R); SAAB 9000(R), LUMINA; TOYOTA; FIAT; ALFA ROMEO 164 2.0(R); HONDA PRELUDE, CRS 16I; GM SATURN(R), GRAND PRIX
801016-5	5 DISC	3/8" ADAPTOR
801016-6	6 DISC	NISSAN PRIMERA; VW GOLF IV
801016-7	7 DISC	AUDI 80, 90, V8+100; COUPE E (R); ROVER 800 ABS; SUBARU L+Z(R); FORD SIERRA ABS, GRANADA, SCORPIO ABS 85(R); NISSAN BLUEBIRD 1.8 TURBO, SILVIA TURBO, PRIMERA 2.0I LS/GS/GSX(R); PEUGEOT 405 1.9GI, GRI, SRI, GTXI, MI 16, 605 2.0SRI (R); TOYOTA CELICA, COROLLA GT, MR2; VW GOLF GTI, JETTA SYNCHRO, JETTA GTI 16V, PASSAT CL, GL, GT, GT 16V, CORRADO 16V, SCIROCCO GTX 16V(R); CITROEN; ALFA ROMEO; FIAT; HONDA; JAGUAR; RENAULT; SAAB; SEAT; LANCIA
801016-8	8 DISC	GM MOST 1-7/8" DIAMETER PISTONS
801016-9	9 DISC	GM MOST 2-1/8" DIAMETER PISTONS
801016-10	A(Z) DISC	RENAULT R21, LAGUNA
801016-11	E DISC	NISSAN MAXIMA; FORD
801016-12	F(G) DISC	OPEL(R)
801016-13	M DISC	FORD; MINI; MAZDA 3
801016-14	N DISC	SAAB; HONDA; ALFA ROMEO; AUDI; VW; LANCIA
801016-15	K DISC	CITROEN

829005



BRAKE PIPE CORROSION TOOL

THIS SCRAPER IS VERY SUITABLE FOR THE REMOVAL OF CORROSION ON THE BRAKE LINES. THIS IS IMPORTANT FOR MOT, MAINTENANCE AND SERVICE. WITH 2-COMPONENT HANDLE.

801018

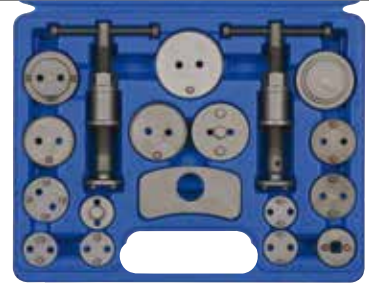

BRAKE CALIPER SERVICE SET 18-PCS

ART. NO.	DESCRIPTION	SUITABLE FOR
805011	BRAKE PISTON RIGHT SPINDLE	RIGHT HAND HELIX BOLT
805010	BRAKE PISTON LEFT SPINDLE	LEFT HAND HELIX BOLT
801018-2	2 DISC	CITROEN XM, XANTIA(F/R)
801018-3	3 DISC	AUDI (F); FIAT; ALFA ROMEO(F); FORD FIESTA(F); ISUZU(F); HONDA CONQUESTO(F); JAGUAR XJ6, XJ40(F/R); BMW 318IS, 320I, 325TD, 518I, 525I, 850CI, M5(F); MERCEDES BENZ 190, 200, 300, 420, 560 SERIES (F); MITSUBISHI COLT(F); NISSAN MICRA, STANZA, SUNNY(F); ROVER AUSTIN, METRO 200 & 400 SERIES, MAESTA, MONTEGO; TOYOTA CAMRY(F); VOLVO(F); VW PASSAT, GOLF GTI(F)
801018-4	4 DISC	FORD AUSTRALIA, NZ TELSTAR; MAZDA(R); SAAB 9000(R); FIAT; ALFA ROMEO 164 2.0(R); HONDA PRELUDE, CRS 16I; GM SATURN(R), GRAND PRIX, LUMINA
801018-5	5 DISC	3/8" ADAPTOR
801018-6	6 DISC	NISSAN PRIMERA; VW GOLF IV
801018-7	7 DISC	AUDI 80, 90, V8+100; COUPE E (R); ROVER 800 ABS; SUBARU L+Z(R); FORD SIERRA ABS, GRANADA, SCORPIO ABS 85(R); NISSAN BLUEBIRD 1.8 TURBO, SILVIA TURBO, PRIMERA 2.0I LS/GS/GSX(R); PEUGEOT 405 1.9GI, GRI, SRI, GTXI, MI 16, 605 2.0SRI (R); TOYOTA CELICA, COROLLA GT, MR2(R); VW GOLF GTI, JETTA SYNCHRO, JETTA GTI 16V, PASSAT CL, GL, GT, GT 16V, CORRADO 16V, SCIROCCO GTX 16V(R)
801018-8	8 DISC	GM MOST 1-7/8" DIAMETER PISTONS
801018-9	9 DISC	GM MOST 2-1/8" DIAMETER PISTONS (CADI SEVILLE/ ELDORADO 80-85)
801018-1	0 DISC	GM MOST 2-1/2" DIAMETER PISTONS (SEVILLE/ELDORADO 79)
801018-10	A DISC	RENAULT R21, LAGUNA (REAR DISK)
801018-11	M DISC	FORD; MINI; MAZDA 3
801018-12	N DISC	SAAB; HONDA
801018-13	F DISC	OPEL (REAR DISK)
801018-14	K DISC	CITROEN
801018-15	E DISC	NISSAN MAXIMA

80501...



BRAKE PISTON SPINDLE

FOR SET 801018, 805002 AND 809007

ART. NO.	CONTENTS
805010	BRAKE PISTON LEFT SPINDLE
805011	BRAKE PISTON RIGHT SPINDLE

805002



809007

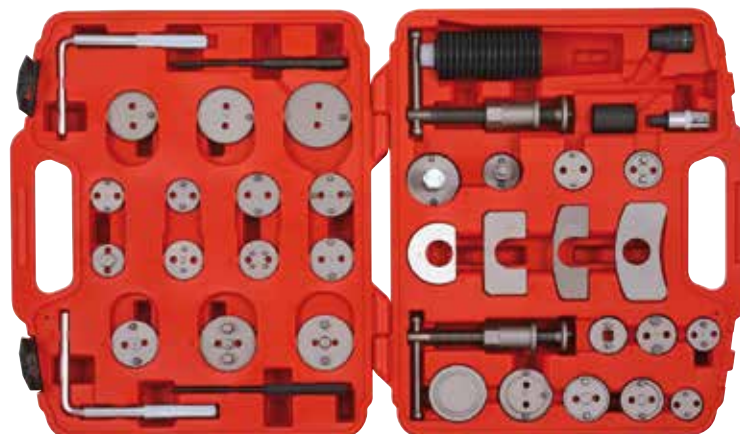
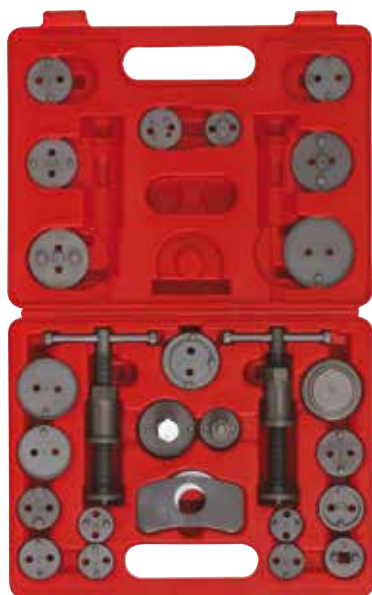

BRAKE CALIPER SET 27-PCS

- 1 RIGHT ROTATING CALIPER (WITH RIGHT SIDE THREAD)
- 1 LEFT ROTATING CALIPER (WITH LEFT SIDE THREAD)
- 1 DISC
- 5-13/32" ADAPTOR(S) WITH 3/8" INNER 4-PT.

ART.NO.	DESCRIPTION	SUITABLE FOR
805002-1	0 DISC	GM MOTORS
805002-2	2 DISC	CITROEN XM, XANTIA U.A.
805002-3	3 DISC	ALFA ROMEO, AUDI, AUSTIN, BMW, FORD, HONDA, JAGUAR, MERCEDES-BENZ, MITSUBISHI, NISSAN, ROVER, TOYOTA, VW
805002-4	4 DISC	ALFA ROMEO 164 2.0, FORD, MAZDA, SAAB 9000, SUBARU
805002-5	6 DISC	NISSAN PRIMERA, VW-GOLF IV
805002-6	7 DISC	AUDI 80, 90, V8 +100, FORD SIERRA ABS+SCORPIO AB 85, HONDA PRELUDE, NISSAN SILVIA 1.8 TURBO, ROVER 8000, SAAB 9000, SUBARU L+Z, VW GOLF, PASSAT
805002-7	8 DISC	GM MOTORS
805002-8	9 DISC	GM MOTORS
805002-19	M DISC	FORD
805002-20	N DISC	SAAB, HONDA
805002-13	E DISC	CEFIRO, MAXIMA
805002-15	G DISC	OPEL
805002-21	O DISC	CITROËN
805002-16	K DISC	CITROËN C5
805002-17...18	K1, K2 DISC	CITROËN, RENAULT
805002-9	A DISC	NISSAN PRIMERA 2.0, BLUEBIRD
805002-10	B DISC	FORD, LINCOLN, SUBARU
805002-11	C Disc	MINI, AUSTIN
805002-12	D Disc	CITROËN, RENAULT
805002-14	F Disc	PEUGEOT 206 CC/HDI, GTI. A 16MM SPANNER IS REQUIRED WITH WIND BACK PISTONS
805002-22	P Disc	AUDI, BMW, FORD, LANCIA, PROTON, RENAULT, ROVER, VW
805002-23	Z Disc	RENAULT

BRAKE CALIPER SET 40-PCS

REWIND TOOL FOR LEFT AND RIGHT HAND THREADED PISTONS AND 12 ADAPTOR(S)

ART.NO.	DESCRIPTION	SUITABLE FOR
809007-2	2 DISC	CITROEN BX(83), 16V(88-), HONDA PRELUDE 2.0I, 23
809007-3	3 DISC	AUDI A3(A4,A6,A8 PUSH-BACK PISTONS), BMW-MOST MODELS(PUSH-BACK PISTONS), CITROEN XM, XM TURBO CT20, XANTIA 1.8I-1.90 8TD-2.0I-2.0 16S(93-94), ACTIVA, CITROEN C5 REAR CALIPERS PUSH-BACK PISTONS, FORD (USA) MERCURY MONARCH, THUNDERBIRD, HONDA-MOST MODELS(PUSH-BACK PISTONS), JAGUAR -MOST MODELS (PUSH-BACK PISTONS), MITSUBISHI MOST MODELS (PUSH-BACK PISTONS), NISSAN-MOST MODELS (PUSH-BACK PISTONS), PEUGEOT 406, 806, ROVER-MOST MODELS(PUSH-BACK PISTONS), TOYOTA-MOST MODELS(PUSH-BACK PISTONS), VOLKSWAGEN-MOST MODELS(PUSH-BACK PISTONS),VOLVO-MOST MODELS
809007-4	4 DISC	ALFA ROMEO 164 2.0 I, FIAT UNO TURBO I- BARCHETTA, FORD ESCORT 2000RS 16V, MONDEO V6 24V, HONDA CIVIC VTI-CRX-ACCORD CONCERTO 5 1.6, ROVER 220 C TURBO (95), SAAB 99L, 900 TURBO(74-81) 900(81-87)
809007-5	6 DISC	JAGUAR S TYPE
809007-6	7 DISC	JAGUAR S SERIES(99-), OPEL ASTRA G, CORSA C, ZAFIRA (WITH LUCAS TRW REAR CALIPERS'02)
809007-7	8 DISC	GM MOTORS
809007-8	9 DISC	GM MOTORS
809007-1	0 DISC	GM MOTORS DISC-CITROEN ZX 2.0I 16V, CITROEN MOST MODELS (PUSH-BACK PISTONS), CITROEN XM, XM TURBO CT 2.0, XANTIA 1.8I-1.90 8 TD-2.0I-2.0 16S(93-94), ACTIVA CITROEN BX(83), BX 16V(88-), CITROEN C3, CITROEN C5(FRONT CALLIPER-LEFT HAND WHEEL,) CITROEN C5 (FRONT CALLIPER-RIGHT HAND WHEEL), CITROEN C5 REAR CALLIPERS PUSH-BACK PISTONS.
809007-9	11 DISC	JAGUAR S TYPE
809007-10	12 DISC	BMW, MINI
809007-20	J DISC	ALFA ROMEO 155 1.8-2.0I 164TD(93), 164 3.0 V6(91), AUDI 80, 90 & V8'S, A3, A4, A6, A8(REAR CALLIPER), CITROEN ZX 2, 0I 16V, FIAT TIPO TD 16V, UNO TURBO(85) TD, FORD SIERRA(ABS BACK), GRANADA(85-), FORD(AUSTRALIA&NZ) THUNDERBIRD TURBO, HONDA CRX 1.6I-16V(88-90), ACCORD 1800(84-85), 2.0I(86-), PRELUDE 16V(88-), LEGEND V6, JAGUAR XJ 40 SERIES, LANCIA DEDRA 2.0 EI TUR(93), DELTA 1.6GTI(92), THE MAJE 16V(92), THÉMA 2000 TURBO, KAPPA 2.0-2.4LS, 2.4TD, NISSAN 280 ZX (82-84), 300 ZX TURBO(84-89), BLUEBIRD 16V(89-), SILVIA 1.8 TURBO (85-88)100NX 2.0(93), PRIMERA 2.0GT(94-), 200 SX TURBO 16V, MAXIMA 2.0 GX 3.0, GX(95), PEUGEOT 306, PEUGEOT 309GTI 16S (91), 405 SRIF O.R.I.GIL(87-), 405 M.I 16V, RENAULT MASTER VAN, ROVER 216 GTI 16V, 820 SI 2.0(93), 825 SD 2.5(93), SAAB 9000 CS 2.0(93), 9000 CSE TURBO (93), SEAT TOLEDO GT 16V, GT 2.0 (93), IBIZA 1.8 GTI 16V(95), SUBARU L-SERIE & SERIE 2, VOLKSWAGEN PASSAT 2.0&2.2 LITER(84), GOLF RALLY(89), GOLF II GTI 16V(89), VENTO GT(92), TRANSPORTER T4+A60, VOLVO 540&V40
809007-21	K DISC	CITROEN C5 REAR CALLIPERS PUSH-BACK PISTONS
809007-22	K1 DISC	CITROEN C5 (FRONT CALLIPER-LEFT HAND WHEEL), CITROEN C5 (FRONT CALLIPER-RIGHT HAND WHEEL)
809007-23	K2 DISC	AUDI A8,S8(99-)
809007-24	M DISC	NISSAN PRIMERA 03
809007-25	N DISC	ALFA ROMEO 164 2.0, TWIN SPARK 2.0, TURBO(8-) 3.0 V6, AUDI 200(80-), COUPE GT SE(82-), 80, 901 00, 200, QUATTRO(87), 90.20V(88-), FORD MONDEO 2.0 GHIA, LANCIA, THEMAALTE(86-), VOLKSWAGEN GOLF II GTI (83-87), SCIROCCO 16V(84)
809007-28	P DISC	CITROEN C3
809007-29	R DISC	FORD (AUSTRALIA&NZ), TELSTAR, LASER, MAZDA 323 GTI, GTX (86-), 929 (82-), RX7(81-), 626 16V (87-), 626 GT(86-), 929 V6(88-), MITSUBISHI GALANT GL SI, TOYOTA CELICA, COROLLA GT, MR2
809007-30	S DISC	AUDI 100TQI(91), BMW 740I 8CYL (91), LANCIA DELTA 1.9 TD(95), PROTON 416, RENAULT-MOST MODELS, RENAULT LAGUNA 2.0(94), LAGUNA 2.2D(95), SAFRANE 2.0-2.2 TD V6, ROVER 623 SI, VOLKSWAGEN GOLF GTI MK III&IV, PASSAT VR6, VENTO GT(92)
809007-31	Z DISC	BMW MINI
809007-18	H6 DISC	BMW-MOST MODELS (PUSH-BACK PISTONS), BMW 740I 8CY1.(91), BMW MINI, VAUXHALL ASTRA G.ZAFIRA
809007-19	H7 DISC	BMW-MOST MODELS (PUSH-BACK PISTONS), BMW 740I 8CY1.(91), BMW MINI, VAUXHALL ASTRA G.ZAFIRA
809007-26	P3.0 DISC	OPEL ASTRAC ZAFIRA(WITH BOSCH REAR CALIPERS), OPEL ASTRA G, CORSA C, ZAFIRA (WITH LUCAS TRW REAR CALIPERS'02) OPEL VECTRA 02, VAUXHALL ASTRA G, ZAFIRA
809007-27	P5.5 DISC	OPEL ASTRAC, ZAFIRA(WITH BOSCH REAR CALIPERS), OPEL ASTRA G, CORSA C, ZAFIRA(WITH LUCAS TRW REAR CALIPERS'02)OPEL VECTRA 02, VAUXHALL ASTRA G, ZAFIRA
1PC	PENTAGON BRAKE SOCKET: 1/2"DRX19M/M: FOR USE ON BENDIX BRAKES	PENTAGON BRAKE SOCKET: 1/2"DRX19M/M: FOR USE ON BENDIX BRAKES
1PC	PENTAGON BRAKE SOCKET: 1/2"DRX14M/M: FOR USE SMART CAR	PENTAGON BRAKE SOCKET: 1/2"DRX14M/M: FOR USE SMART CAR
1PC	PENTAGON BRAKE SOCKET: 1/2"DRX10M/M: FOR USE ON GIRLING BRAKES	PENTAGON BRAKE SOCKET: 1/2"DRX10M/M: FOR USE ON GIRLING BRAKES
809007-32	FLEXIBLE POT FOR GREASE	FLEXIBLE POT FOR GREASE
809007-11	A DISC	NISSAN PRIMERA 2.0, OPEL ASTRAC ZAFIRA(WITH BOSCH REAR CALIPERS), VAUXHALL ASTRA G.ZAFIRA
809007-12	B DISC	FORD(USA) MERCURY ,MONARCH, THUNDERBIRD LINCOLN CONTINENTAL SUBARU 1600 KOMBI(79-)-1.6-1.8 SRX, KOMBI(79-83),1800(84),1800 LIM, KOMBI,TOURISMO 4WD (82-83),1800GT, GTSXT ,TURBO(85)
809007-13	C DISC	NISSAN PRIMERA(02),OPEL VECTRA 02-,TOYOTA AVENSIS
809007-14	D DISC	CITROEN BX(83),BX 16V(88-)
809007-15	E DISC	NISSAN MAXIMAS
809007-16	F DISC	PEUGEOT 206'03
809007-17	G DISC	FIAT STILO

812006



BRAKE PISTON REWINDING CUBE

UNIVERSALLY APPLICABLE FOR WINDING BACK BRAKE PISTONS ON HAND-BRAKE SECURED BRAKE CALIPERS

i 816001

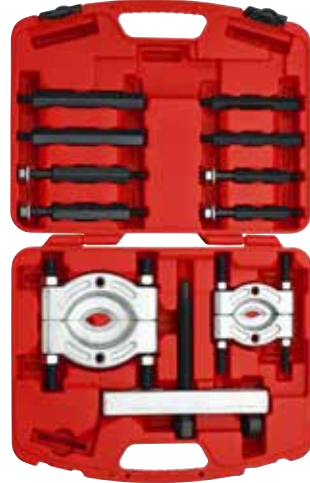

TWO SETS GEAR & BEARING SPLIT TOOLS

MECHANICAL PULLER SET WITH 030-55MM AND 050-75MM SEPARATORS AND SINGLE YOKE WITH 180MM THRUST BOLT.

SUITABLE FOR ENGINEERING AUTOMOTIVE, MARINE AND AGRICULTURAL APPLICATIONS.

- BEARING SEPARATOR & BOLTS: 1 SET
- S45C DROP FORGED HARDENED 42° - 45°
- CAPACITY RANGE: 30 ~ 50 MM
- (BOLT 3/8" X L 120MM X 24T S45C HARDENED 42° - 45°)

- BEARING SEPARATOR & BOLTS: 1 SET
- S45C DROP FORGED HARDENED 42° - 45°
- CAPACITY RANGE: 50 ~ 75 MM
- (BOLT 1/2" X L 135MM X 20T S45C HARDENED 42° - 45°)

- MAIN ROD: 4 PIECES HEX BAR 17MM 3/8" X L125MM X 16T

- EXTENSION ROD: 4 PIECES
- HEX BAR 14MM 3/8" X L110MM X 16T

- CENTRE BOLT: 1 PIECES
- 5/8" X L175 X 18T/INCH CARBON STEEL

- BEAM: 1 PIECE
- CARBON STEEL

48131



SAFETY SET E4 2-PCS

- WARNING TRIANGLE
- REFLECTIVE VEST

820007



CLEANING BRUSH KIT 38-PCS

COMPRISING A HANDLE WITH EXTENSION AND 36 ASSORTED BRUSHES WITH 1/4" DRIVE AND 8-9-10-11-12-13-14-15-16-17-18-19 MM DIAMETER FOR CLEANING AND DEBURRING CYLINDERS, BUSHINGS, PIPES AND OTHER WORK PIECES WITH NYLON, BRASS AND STEEL FACING.

APPLICATION EXAMPLES ARE:

- BRAKE CALLIPERS SLEEVE
- O-RING CUT-INS
- INJECTOR SEAT
- VALVES ON EXHAUST GAS RECIRCULATION
- INLETS AND OUTLETS
- CROSSBAR SEAL ON INJECTION LINES ON OPEL CYLINDER HEADS

i **SGO**

48113



HOT AIR GUN 2000W

- COMPACT AND LIGHTWEIGHT FOR EASY HANDLING
- STRIPS PAINT AND VANISH THAWS FROZEN METAL
- PIPES, LOOSENS TILE AND PUTTY, REMELTS ADHESIVES AND MORE
- CERAMIC OR MICA CORE PROTECTS THE HEATING ELEMENT FOR LONGER LIFE
- THERMOCOUPLE CONTROL MAINTAINS PRECISE TEMPERATURE
- VOLTAGE FREQUENCY 230V 50HZ
- INPUT POWER 2000W
- AIR FLOW 480L/MIN
- AIR TEMPERATURE 100-300°C 100-600°C

i **SGO**

829002



DIESEL INJECTOR SEAT CLEANER SET 14-PCS

ART. NO.	DESCRIPTION
829002-01	(A) INJECTOR NOZZLE PORT CLEANER
829002-02	(B)(C)(D) CLEANING BRUSH (INNER INJECTOR PORT) 18/22/25MM
829002-03	(H)(I) CLEANING BRUSH (BASE/INJECTOR SEAT AREA) 15/20MM
829002-04	(E) QUICK CHUCK 224MM FLEXIBLE EXTENSION
829002-05	(F) INSERTION ROD FOR "INJECTOR NOZZLE PORT SEALING PLUGS"
829002-06	(G) INJECTOR NOZZLE PORT SEALING PLUGS (6 PCS)

825001



CLAMP TENSIONER CV BOOT TOOL

- FOR 1/4" - 3/8" BANDS AND CLAMPS
- RATCHET TENSION WINDING MECHANISM, NO NEED TO USE EXTRA TOOLS
- BUILT-IN CUTTER TO CUT THE BAND TO APPROPRIATE LENGTH

i **SGO**

805018



CLAMP TENSIONER CV BOOT TOOL

- TESTING RANGE 0-2.5 BAR
- SUITABLE FOR ALL STANDARD VEHICLES

i **SGO**

300306



PENTAGON SOCKET SET 1/2", 3-PCS

ART. NO.	DESCRIPTION
300306-1	PENTAGON BRAKE SOCKET: 1/2" DRX19M/M: FOR USE ON BENDIX BRAK
300306-2	PENTAGON BRAKE SOCKET: 1/2" DRX14M/M: FOR USE SMART CAR
300306-3	PENTAGON BRAKE SOCKET: 1/2" DRX10M/M: FOR USE ON GIRLING BRA

i

47015



814...



808001

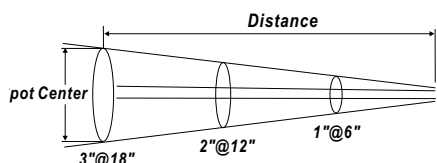

Distance to Spot size = 6:1

HANDHELD INFRARED THERMOMETER

- MEASURES SURFACE TEMPERATURE WITHOUT CONTACT
- LASER POINTER FOR ACCURATE USE
- EASY TO READ LARGE DIGITAL DISPLAY
- BLUE BACKLIGHT
- LOW BATTERY INDICATION
- TEMPERATURE RANGE -20°C TO 320°C / -4°F TO 608°F
- DISTANCE FACTOR 6:1 (DISTANCE TO SPOT SIZE)
- ACCURACY ±2°C (±3°F) OR 2% OF READING
- REPEATABILITY 2% OF ±2°C (±3°F)
- RESPONSE TIME 500MSEC, 95%
- SPECTRAL RESPONSE 7-18UM
- EMISSIVITY 0.95
- AMBIENT OPERATING RANGE 32°F-105°F
- RELATIVE HUMIDITY 10-95% RH NO CONDENSING AT UP TO 86°F
- STORAGE TEMP -4°F TO 150°F WITHOUT BATTERY
- 9V BATTERY
- DIMENSIONS 90X155X45MM
- WEIGHT 150G
- BATTERY LIFE 12HRS



TORQUE MULTIPLIER

- ACCURACY ±5%
- HEAVY-DUTY CONSTRUCTION REDUCES MAINTAINED PROCEDURES
- PRECISION GEAR MECHANISM APPLIED HIGH TORQUE OUTPUT WITH LOW INPUT
- SUPPLIED TO REACT ACCESSORIES FOR COMBINED

ART. NO.	DESCRIPTION	SPECIFICATIONS
814001	TORQUE MULTIPLIER 1700NM / 1250FT-LB	- INPUT SQUARE: 1/2" SQUARE (F) - OUTPUT SQUARE: 3/4" SQUARE (M) - MAXIMUM RANGE: 1500NM/960FT-LB - RATIO: 5:1 - GEAR RATION: 1: 4.33 - TOOL WEIGHT: 3.5KG - REACTION ACCESSORY: 2-PCS - SURFACE FINISHED: MAT
814002	TORQUE MULTIPLIER 2700NM / 2000 FT-LB	- INPUT SQUARE: 3/4" SQUARE (F) - OUTPUT SQUARE: 1" SQUARE (M) - MAXIMUM RANGE: 2700NM/2000FT-LB - RATIO: 5:1 - GEAR RATION: 1: 4.33 - TOOL WEIGHT: 3.5KG - REACTION ACCESSORY: 2-PCS - SURFACE FINISHED: MAT



SLIDE HAMMER PULLER SET

THIS MOST USEFUL TOOL CAN PULL FLANGE-TYPE REAR AXLES, REMOVE STUBBON OIL SEALS & BEARING OR PRESS-FIT PARTS. USE AS A DENT PULLER OR LIP PULLER. REVERSIBLE JAWS CAN BE SET UP FOR 2/3 JAW IN-EXTERNAL USAGE, 1/2"-20 THREAD ADAPTOR EXPANDS THE SLIDE HAMMER FOR EXTRA PULLING FUNCTIONS.

47401



BALL JOINT SEPARATOR (JAW 20MM)

47402



BALL JOINT SEPARATOR (JAW 20MM)

- FOR SPLITTING TRACK-ROD ENDS, ANTI-TOLL BAR MOUNTINGS, BALL JOINTS, ETC.
- JAW OPEN: 20MM

201203



812001



47403



12-PCS 3/8" CRAWFOOT SET

IDEAL FOR INJECTION LINES, AIR-CONDITIONING SYSTEMS, BRAKE LINES, COMPRESSED AIR AND HYDRAULIC LINES, OIL PRESSURE SWITCHES, (3/8") DRIVE

ART. NO.	DESCRIPTION
201203-1	SWIVEL HANDLE 3/8" 250MM
201203-2	EXTENSION 3/8" 150MM
201203-3...12	3/8" DR. CRAWFOOT 10, 11, 12, 13, 14, 15, 16, 17, 18, 19MM

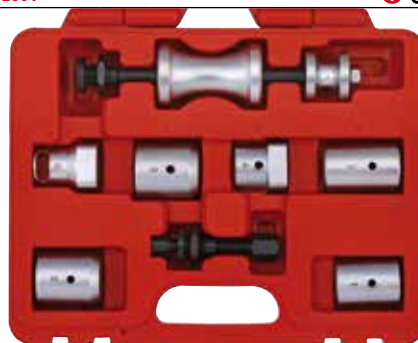

WIPER REMOVAL KIT

ART. NO.	DESCRIPTION
812001-1	EXTRACTORS SIZE 1
812001-2	EXTRACTORS SIZE 2
812001-3	EXTRACTORS SIZE 3
812001-4	EXTRACTORS SIZE 4
812001-5	EXTRACTORS SIZE 5
812001-6	EXTRACTORS SIZE 6
812001-7	REMOVER
812001-8	PRESSURE SPINDLE

BALL JOINT SEPARATOR (JAW 22MM)

- SPECIAL DESIGN 2-STANGE OPERATING SUITS MOST CARS AND LIGHTTRUCKS BALL JOINTS IN STEERING & SUSPENSION
- OFFSET LEVER PERMITS MAXIMUM JAW OPENING IN 30MM & 50MM
- JAW OPEN: 22MM



301302



47404



CRAWFOOT SET 1/2", 13-PCS

IDEAL FOR INJECTION LINES, AIR-CONDITIONING SYSTEMS, BRAKE LINES, COMPRESSED AIR AND HYDRAULIC LINES, OIL PRESSURE SWITCHES, 12,5 MM (1/2") DRIVE

ART. NO.	DESCRIPTION
301302-1	SWIVEL HANDLE 1/2" 385MM
301302-2	EXTENSION 1/2" 125MM
301302-3...13	1/2" DR. CRAWFOOT 20, 21, 22, 23, 24, 25, 26, 27, 28, 30, 32MM



BALL JOINT SEPARATOR (JAW 22MM)

- FOR SPLITTING TRACK-ROD ENDS, ANTI-TOLL BAR MOUNTINGS, WHEEL-HUB BALL JOINTS, ETC.
- 2-STAGE, 50-80MM
- JAW OPEN: 22MM

48307...



47571



REVERSIBLE PULLER

- JAWS GRIP TIGHTER AS MORE PRESSURE IS APPLIED
- REVERSIBLE JAWS
- DROP FORGED
- ALLOY STEEL
- HARDENED 45° HRC

ART. NO.	DESCRIPTION	SPECIFICATIONS
4830703	2-3 JAW 3" REVERSIBLE PULLER	- SPREAD: 4" - REACH: 2-1/2" - CAPACITY: 2 TON
4830704	2-3 JAW 4" REVERSIBLE PULLER	- SPREAD: 6" - REACH: 3-1/2" - CAPACITY: 5 TON
4830706	2-3 JAW 6" REVERSIBLE PULLER	- SPREAD: 8" - REACH: 3-1/2" - CAPACITY: 5 TON

47242



PROFESSIONAL CAR SHEET COVER, MULTI USE

- 210D NYLON WITH ELASTIC BAND
- WASH ON 40 DEGREE
- COLOUR RED, WITH BLACK SONIC PRINT

48104



FENDER PROTECTOR WITH SUCTION CUPS

- LENGTH: 106,5CM
- WIDTH: 64CM
- WEIGHT: 380GR

47570



NON SLIP WING & GRILL COVER

- CONCERNS SURROUNDING THE USE OF MAGNETIC WING COVERS IN CAR WORKSHOPS CAN NOW BE OVERCOME WITH OUR NEW NON MAGNETIC WING COVER. UTILISING A CLEVER NON-SLIP MATERIAL ON THE REVERSE SIDE ALONG WITH A WIPE CLEAN SURFACE TO THE FRONT.
- THESE COVERS WILL HANG ALMOST VERTICAL TO PROTECT AGAINST SCRATCHES AND DAMAGE
- WASHABLE AT 40°C
- OIL, GREASE, DIRT AND WATER REPELLENT
- MEETS NATIONAL AND INTERNATIONAL FIRE RETARDENCY STANDARDS
- SIZE: 90 X 50 CM (WING COVER)



FENDER PROTECTION SYSTEM / CCPS

- PROTECTS THE VULNERABLE AREAS OF THE BODYWORK (FRONT GRILL, FENDER, HEADLIGHTS, CAR MAKE BADGES, BUMPER, ...) DURING GENERAL SERVICING, INSPECTION, MOBIL AIRCO SERVICE,...
- UNIVERSAL VEHICLE FIT: ONE SIZE FITS ALL - FROM ESTATE TO MINI!
- UNIQUE WHEEL ACCESS: ALLOWS SERVICING OF BRAKES, SUSPENSION
- MESH FRONT LAMP SECTION ALLOW LIGHTING TESTS WITHOUT OVERHEATING
- RADIATOR SECTION WITH NYLON MESH ALLOWS FOR STATIONARY MOTOR TESTING WITHOUT THE RISK OF OVERHEATING
- UNIQUE REMOVABLE PROTECTIVE FABRIC PANEL (FULLY MACHINE WASHABLE) TO PREVENT RUBBING/ DAMAGE WHEN THE TECHNICIAN LEANS INTO THE ENGINE BAY
- COMES IN A CONVENIENT STORAGE BAG

48105



CREEPER

- LENGTH: 100CM
- WIDTH: 48CM
- HEIGHT: 11,5CM
- WHEELS ALSO LOOSE AVAILABLE; ARTICLE NUMBER 48105W

48126



ADJUSTABLE ROLLER SEAT PNEUMATIC 5 WHEELS

- ADJUSTABLE HEIGHT 375-495MM

48112



HEAVY DUTY OIL DRAIN PAN

- FOR PROFESSIONALLY REPLACING OF MOTOR OILS, CLEANING OF PARTS OR COLLECTING OF OTHER LIQUIDS. THIS DRAIN PAN INCLUDES A NOZZLE FOR EASY PORING OF THE CONTENTS. WITH THREE GRIPS THIS DRAIN PAN IS COMFORTABLE TO USE.
- 15,9 LITER
- EASY POURING NO MESS SPOUT
- CONVENIENT FRONT AND REAR HANDLES
- BIG ENOUGH FOR ANY APPLICATION
- EXTRA THICK QUALITY

4821901



MULTI PURPOSE PAN, 20 LITER

- MULTI PURPOSE PAN, PLASTIC, BLACK
- PAN VOLUME 20 LTR.
- DRAIN SPOUT FOR EASY EMPTYING
- LOOP FOR PULLING AND HANGING UP THE PAN
- DIMENSIONS APPROX. 685 X 667 X 65MM (L X W X H)

4821902



MULTI PURPOSE PAN, 50 LITER

- MULTI PURPOSE PAN, PLASTIC, BLACK
- PAN VOLUME 50 LTR.
- DRAIN SPOUT FOR EASY EMPTYING
- DIMENSIONS APPROX. 800 X 600 X 100MM (L X W X H)

487001



MAGNETIC TRAY 4" 15CM

- ALSO AVAILABLE IN DISPLAY WITH 8 PIECES

487002



MAGNETIC TRAY 6 X 9" / 24 X 14CM

- ALSO AVAILABLE IN DISPLAY WITH 10 PIECES

818001



CLUTCH ALIGNER SET 15-28MM

- AS A RESULT OF PARALLEL EXPANSION TECHNIQUE IT IS POSSIBLE TO ALIGN THE CLUTCH PLATE TO THE PILOT BEARING IN THE CRANKSHAFT FLYWHEEL. FOR CLUTCH-HUB-Ø: 15 - 28MM

818002



OXYGEN SENSOR WRENCH

- 6PT. WRENCH 22MM WITH FLEXIBLE HEAD.
- 250MML
- SUITABLE FOR HEATED AND UNHEATED OXYGEN SENSORS.
- CUT-OUT SECTION ALLOWS SOCKET TO PASS OVER WIRING.
- SUITABLE FOR VW, AUDI, BMW, MERCEDES, FORD, OPEL/VAUXHALL, PEUGOT, CITROEN, RENAULT, SEAT, SKODA, JAPANESE CARS

818003



BELT GAUGE

- THIS TENSIONING GAUGE CAN BE USED TO ADJUST THE TENSION ON THE CAM BELTS WHERE THE MOVEMENT OF THE TIMING BELT IS MEASURED BY LOAD
- SUITABLE FOR USE ON CAM BELTS WITH VARIOUS BELT THICKNESS.
- CLEAR INCREMENTAL MARKING WITH KNURLED KNOB FOR PRECISE MEASUREMENT.
- DUAL SCALE ALLOWS READING FROM TOP OR BOTTOM OF TOOL.

818004



DIESEL INJECTOR SEAT CLEANER SET 7-PCS

SET OF FIVE DIESEL INJECTORS SEAT CLEANERS A CENTERING PILOT AND T-HANDLE. USE TO CLEAN/ DECARBONISE INJECTOR SEATS WHEN CHANGING INJECTORS. HELPS TO AVOID BLOW-BACK DUE TO POORLY SEATED INJECTORS.

ART. NO.	DESCRIPTION
818004-1	T-HANDLE
818004-2	PILOT POST
818004-3	15MM FLAT REAMER
818004-4	17MM FLAT REAMER
818004-5	17MM ANGLED
818004-6	17MMX19MM FLAT REAMER
818004-7	17MMX21MM ANGLED RESMER

805012



INJECTOR/INJECTOR-EXTRACTION TOOL SET

SPECIALLY FOR VW / AUDI / SEAT / SKODA, SUITABLE FOR
 • SDI- / TDI- UND TFSI- DIESEL ENGINE (ALSO PUMP/NOZZLE AND COMMON RAIL)
 • FSI GASOLINE ENGINES

FOR THE PROFESSIONAL DISMANTLING AND INSTALLATION OF INJECTORS / INJECTION VALVES AS WELL AS THE UNIT PUMP NOZZLE. THE STRIKING WEIGHT ALSO ENABLES THE REMOVAL OF JAMMED ELEMENTS.

829003



DIESEL INJECTOR EXTRACTOR WITH ADAPTORS

ESSENTIAL SET TO PROFESSIONALLY REMOVE INJECTORS FROM THE CYLINDER HEAD.

ART. NO.	DESCRIPTION
829003-01	EMPTY CASE 829003
829003-02	FOAM 829003
829003-03	AIR HAMMER EXTRACTOR
829003-04	(A) DIESEL INJECTOR ADAPTOR - SIEMENS
829003-05	(B) DIESEL INJECTOR ADAPTOR - DENSO
829003-06	(C) DIESEL INJECTOR ADAPTOR - SIEMENS
829003-07	(D) DIESEL INJECTOR ADAPTOR - HIGH PRESSURE M12
829003-08	(E) DIESEL INJECTOR ADAPTOR - DELPHI
829003-09	(F) DIESEL INJECTOR ADAPTOR - OFF-LINE
829003-10	(G) VALVE SEAT REMOVAL TOOL - DENSO (1.43USD)
829003-11	(H) M16 DENSO ADAPTER
829003-12	(I) DUAL CONNECTION ADAPTOR - BOSCH
829003-13	(J) BOSCH INJECTOR DISMANTLING TOOL

810005



OXYGEN SENSOR SOCKET 1/2", 150L 22

EXTRA LONG, SLITTED VERSION FOR DEEPLY INGRAINED OXYGEN SENSORS, SUITABLE FOR:
 - BMW, FORD, MERCEDES, OPEL, VAG, ETC.
 - 150MML, 22MM

818008



CLUTCH ALIGNMENT TOOL SET

TOOL SET FOR PRE-TENSIONING SELF ADJUSTING CLUTCHES BEFORE REMOVAL OR INSTALLATION. PREVENTS PLATE DISTORTION WHICH MAY PREVENT THE CLUTCH FROM DISENGAGING OF CAUSE DRAGGING. CONSISTS A REFITTING TOOL, ALLOWING THE CLUTCH ADJUSTER TO BE WOUND BACK, AND SIX ALIGNMENT ADAPTORS.

819005

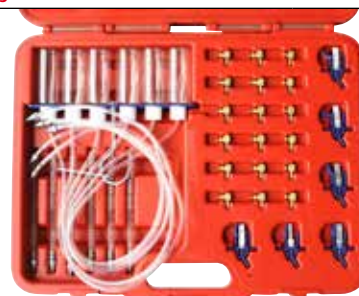

COMMON RAIL FLOW METER SET

- TO MEASURE RETURN FUEL FLOW ON DIESEL VEHICLES UP TO 6 CYLINDERS FITTED WITH COMMON RAIL INJECTION SYSTEM.
 - DETERMINATION OF THE RUNBACK VOLUME VIA GLASS TUBES OR MEASUREMENTS CARTRIDGES.
 - INCLUDES 6 GLASS TUBES, 6 MEASUREMENTS CARTRIDGES WITH CONNECTING LINES, MOUNTED ON A ALUMINUM BAR.

818009



COMMON RAIL FLOW METER SET

- TO MEASURE RETURN FUEL FLOW ON DIESEL VEHICLES UP TO 8 CYLINDERS FITTED WITH COMMON RAIL INJECTION SYSTEM.
 - DETERMINATION OF THE RUNBACK VOLUME VIA GLASS TUBES OR MEASUREMENTS CARTRIDGES.
 - INCLUDES 8 GLASS TUBES, 8 MEASUREMENTS CARTRIDGES WITH CONNECTING LINES, MOUNTED ON AN ALUMINUM BAR.

818010



MASTER COMPRESSION TEST SET

A COMPREHENSIVE SET FOR TESTING THE COMPRESSION ON DIESEL VEHICLES. FEATURES 600PSI GAUGE WITH LARGE RUBBER BUMPER, STRAIGHT AND RIGHT ANGLED QUICK CONNECT FITTINGS AND AN EXTENSIVE RANGE OF SPARK/GLOW PLUG AND INJECTOR ADAPTORS.

- SPARK PLUG SIZES: 10, 12, 14, 18MM
- GLOW PLUG ADAPTORS: ALFA ROMEO, BMW, CHRYSLER, CITROEN, DAEWOO, FIAT, FORD, HONDA, HYUNDAI, ISUZU, JEEP, KIA, LADA, LANCIA, LAND ROVER, LDV, MAZDA, MERCEDES, MG, MITSUBISHI, NISSAN, PEUGEOT, RENAULT, ROVER, SAAB, SSANGYONG, SUZUKI, TOYOTA, VAG, VAUXHALL / OPEL, VOLVO
- INJECTOR ADAPTOR: M20, M22, M24 & FORD STANADYNE INJECTORS PLUS CLAMP-ON INJECTORS

818011



OIL PRESSURE TEST SET

TESTS OIL PUMP PRESSURE AND ALSO LOW OIL WARNING DEVICES. Ø75MM GAUGE FITTED WITH HEAVY DUTY COVER. FITTED WITH QUICK COUPLING ADAPTORS AND 1200MM HOSE. INCLUDES 90° COUPLING ADAPTOR FOR LIMITED ACCESS APPLICATIONS.

826001



VACUUM PUMP SET

FOR UNIVERSAL USE, FOR BUILDING UP PRESSURE AND VACUUM. COMPLETE WITH HOSE AND VARIOUS COUPLINGS IN A CASE. IDEAL FOR BRAKE AND CLUTCH BLEEDER AND TO BLEED THE FUEL SYSTEM AS AT (ISA) V6 TDI ENGINES AS WELL AS FOR TESTING.

- VACUUM CELLS E.G. ON AIR-CONDITIONING SYSTEMS
- TURBOCHARGERS ETC.
- VACUUM - 0,8 BAR
- PRESSURE - 4 BAR

819009



CYLINDER PRESSURE METER SET

QUICK CONNECT / DISCONNECT FEATURE ALLOWS ONE GAUGE TO BE USED WITH VARIETY OF QUICK ADAPTORS FOR MOST POPULAR DIESEL ENGINES. PUSH PRESSURE SCALE: 0-<->1000PSI 0-<->70 BAR

818012



LEAK BACK TEST SET

SPECIALLY DESIGNED TO TEST THE RETURN FLOW FUEL PRESSURE FROM PIEZO DIESEL COMMON RAIL INJECTORS ON BOSCH, DELPHI AND SIEMENS SYSTEMS. SUPPLIED WITH TWO GAUGES; -1 TO +3 BAR AND -1 TO +15 BAR. SIGHT-GLASS THAT IDENTIFIES AIR IN THE FUEL SYSTEM AND DRAIN VALVE ALLOWS SAFE RECOVERY OF FUEL.

818014



RADIATOR PRESSURE TEST SET 17-PCS

- TESTING RANGE 0-2,5 BAR
- SUITABLE FOR ALL STANDARD VEHICLES

818015



PETROL ENGINE COMPRESSION TEST SET

COMPRESSION TESTER FITTED WITH Ø63MM GAUGE READING UP TO 300PSI AND 20KG/CM². SET INCLUDES 130MM STRAIGHT AND ANGLED PUSH-ON CONNECTORS, 400MM FLEXIBLE EXTENSION WITH 10, 12, 14 AND 18MM ADAPTORS.

818016



CAMSHAFT & CRANKSHAFT LOCKING SET

ANODIZED ALUMINUM CHOCKS SUITABLE FOR LOCKING CAMSHAFT PULLEYS ON TWIN CAM ENGINES. ALLOWS THE SERVICE EASIER AND REDUCE THE RISK OF INCORRECT VALVE TIMING FROM TAKING PLACE. SET INCLUDES FLYWHEEL LOCKING TOOLS FOR SELECTED PSA (CITROEN/PEUGEOT) AND GM (VAUXHALL / OPEL) PETROL AND DIESEL ENGINES. SUITABLE FOR A RANGE OF VEHICLES INCLUDING: FORD, HONDA, LAND ROVER, ROVER, VW, RENAULT, CITROEN, PEUGEOT, FIAT AND VAUXHALL/OPEL.

ART. NO.	DESCRIPTION
818016-1	A. CAMSHAFT SETTING AND LOCKING PLATE
818016-2	Q. BALANCER SHAFT LOCKING PIN
818016-3	O. CRANKSHAFT TDC LOCATION PIN
818016-4	N. CAMSHAFT LOCKING PINS (5.0MM, PAIR)
818016-5	P. CAMSHAFT LOCKING PINS (6.8MM, PAIR)
818016-6	K. FLYWHEEL HOLDING TOOL
818016-7	M. FLYWHEEL HOLDING TOOL
818016-8	B. CAMSHAFT LOCKING TOOL
818016-9	C. CAMSHAFT LOCKING TOOL
818016-10	D. CAMSHAFT LOCKING TOOL
818016-11	E. CAMSHAFT LOCKING TOOL
818016-12	F. CAMSHAFT LOCKING TOOL
818016-13	G. CAMSHAFT LOCKING TOOL
818016-14	H. CAMSHAFT LOCKING TOOL
818016-15	I. CAMSHAFT LOCKING TOOL
818016-16	J. CAMSHAFT LOCKING TOOL
818016-17	L. CAMSHAFT LOCKING TOOL

818017



TOOTH BELT TOOL SET 3-PCS

- SET FOR WORKING AND LOCKING THE TOOTH BELT TENSIONER ROLLS
- TIMING BELT TENSIONER PINS-OEM NOS T10115, T40011 AND SERPENTINE TENSION PIN-T10060/A.
- FOR USE ON: LUPO. POLO 1.4 TDI PD GOLF, BORA, POLO 1.9 TDI PD, BEETLE, SHARAN 1.9 TDI PD, PASSAT 1.9 TDI PD, AUDI A2 / A3 1.4 / 1.9 TDI PD, A4 / A6 1.9 TDI, A4 / A6 / A8 / ALLROAD 2.5 V6 TDI.

47815

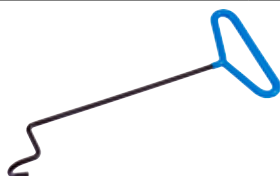

DOUGHNUT STRETCHER

FOR REMOVING THE RETAINING RUBBERS ON EXHAUST SYSTEMS

47816



FITTING HOOK

PERFECT FOR THE REMOVAL AND FITTING OF SPRINGS ON BRAKES, HEADLIGHTS, MOTORBIKE MUFFLERS AND MUCH MORE BESIDES. THE BENT SHAPE OF THE SPRING HOOK ALLOWS A FREE VIEW OF THE FITTING SPOT

820006



AXIAL JOINT TOOL SET, 30-45MM

- FOR FAST AND PROFESSIONAL CHANGING OF THE AXIAL JOINTS OF CARS
- AUTOMATIC CLAMPING OF THE JOINT HEADS
- EASY ASSEMBLING OF LONG TIE RODS BECAUSE OF OPEN CONSTRUCTION
- SAVES UP TO 3 HOURS OF WORKING TIME
- FOR JOINT HEADS Ø30-35MM, Ø35-40MM AND Ø40-45MM

ART. NO.	DESCRIPTION
820006-1	AXIAL JOINT TOOL
820006-2	JOINT HEADS Ø30-35MM
820006-3	JOINT HEADS Ø30-40MM
820006-4	JOINT HEADS Ø40-45MM

818021

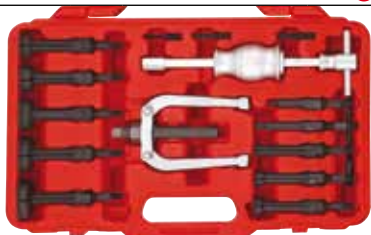

BLIND HOLE BEARING PULLER SET

- 10-PCS CLAMPS: 8-11MM, 12-17MM, 18-23MM, 24-29MM, 30-34MM, 34-37MM, 39-42MM, 44-47MM, 49-52MM, 54-57MM
- 3PCS SCREW: M10X1.5P, M10X1.5P & M8X1.25P, M10X1.5P & M6X1.0P
- ONE SLIDE HAMMER
- ONE TWO JAW PULLER

ART. NO.	DESCRIPTION
818021-1	ONE SLIDE HAMMER
818021-2	ONE TWO JAW PULLER
818021-3	CLAMP 8-11MM
818021-4	CLAMP 12-17MM
818021-5	CLAMP 18-23MM
818021-6	CLAMP 24-29MM
818021-7	CLAMP 30-34MM
818021-8	CLAMP 34-37MM
818021-9	CLAMP 39-42MM
818021-10	CLAMP 44-47MM
818021-11	CLAMP 49-52MM
818021-12	CLAMP 54-57MM
818021-13	SCREW M10X1.5P
818021-14	SCREW M8X1.25P
818021-15	SCREW M6X1.0P

819001



NUT BREAKER SET 4-PCS

- FLAT ROUND HEAD DESIGN ALLOWS TOOL TO BE USED IN INACCESSIBLE AREAS DRIVE TO PREVENT BINDING UNDER LOAD.
- DOES NOT DAMAGE THE BOLTS THREADS.

ART. NO.	DESCRIPTION
819001-1	5/16" -1/2" (9-12MM)
819001-2	1/2" -5/8" (12-16MM)
819001-3	5/8" -7/8" (16-22MM)
819001-4	7/8" -1.1/8" (22-27MM)

819002



FORK ROD SET 5-PCS

- FORKS MADE OF DROP FORGED HEAVY DUTY CHROME VANADIUM STEEL

ART. NO.	DESCRIPTION
819002-1	1 HANDLE FOR USE WITH PNEUMATIC AIR HAMMER
819002-2	BOTH HANDLES ARE INTERCHANGEABLE
819002-3	DROP FORGED FORKS 11/16"
819002-4	DROP FORGED FORKS 15/16"
819002-5	DROP FORGED FORKS 1-1/8"

818028

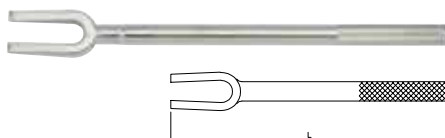

SEPARATING AND MOUNTING FORK 16"

- FOR TIE-ROD ENDS AND STEERING COLUMN STALK -410MML

805017

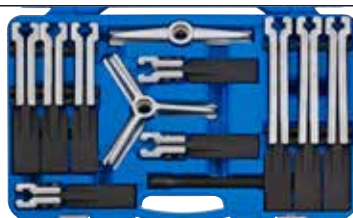

UNIVERSAL HEAVY DUTY PULLER SET 12-PCS

- FORGED, CHROME-MOLYBDENUM STEEL, 2 AND 3-ARM CAN BE USED
- 100 - 200 - 250 MM CLAMPING WIDTH
- CAN BE USED AS INNER AND OUTER REMOVER
- REPLACEABLE, HARDENED REMOVER BASES (CA. 25 MM)
- CLAMPING WIDTH MAX. 130 MM

818023



TEST LEAD SET 92-PCS

COMPREHENSIVE SET OF TEST LEADS AND COMPONENTS SUITABLE FOR TESTING, ISOLATING AND EVALUATING AUTOMOTIVE ELECTRONIC CIRCUITS. SET INCLUDES STANDARD Ø2.4MM BANANA STYLE PLUGS AND SOCKETS SUITABLE FOR USE WITH MOST DIAGNOSTIC MULTIMETERS AND TEST EQUIPMENT.

818024



AIR CONDITIONING SPRING LOCK COUPLING SET

SPRING TYPE COUPLING CONNECTORS FOR AIR CONDITIONING LINES. LOCKING ACTION PREVENTS SPRAY WHEN DISCONNECTING LINES. SUITABLE FOR MOST FORD, VAUXHALL/OPEL AND CHRYSLER VEHICLES.

ART. NO.	DESCRIPTION
818024-1	COUPLING TOOLS 3/8"
818024-2	COUPLING TOOLS 1/2"
818024-3	COUPLING TOOLS 5/8"
818024-4	COUPLING TOOLS 3/4"

818025



FUEL & AIR CONDITIONING TOOL SET 22-PCS

COMPREHENSIVE KIT FOR SEPARATING AUTOMOTIVE AIR CONDITIONING HOSES AND FUEL LINES. SUITABLE FOR A WIDE VARIETY OF VEHICLES.

ART. NO.	DESCRIPTION
818024-1	COUPLING TOOLS 3/8"
818024-2	COUPLING TOOLS 1/2"
818024-3	COUPLING TOOLS 5/8"
818024-4	COUPLING TOOLS 3/4"
818024-5	COLOR CODED DISCONNECTING 5/16"
818024-6	COLOR CODED DISCONNECTING 3/8"
818024-7	COLOR CODED DISCONNECTING 1/2"
818024-8	COLOR CODED DISCONNECTING 5/8"
818024-9	COLOR CODED DISCONNECTING 3/4"
818024-10	COLOR CODED DISCONNECTING 7/8"
818024-11	FUEL LINE DISCONNECT TOOL
818024-12	FORD OIL COOLING LINE DISCONNECT TOOL
818024-13	FORD OIL COOLING LINE COUPLING TOOL
818024-14	FORD/ VAUXHALL/ OPEL QUICK DISCONNECT TOOL
818024-15	DISCONNECTING 1
818024-16	DISCONNECTING 2
818024-17	DISCONNECTING 3
818024-18	DISCONNECTING 4
818024-19	DISCONNECTING 5
818024-20	DISCONNECTING 6
818024-21	DISCONNECTING 7
818024-22	SPARE RUBBER BANDS

812005



BRAKE TOOL SET

- COMPREHENSIVE, 15-PCS UNIVERSAL BRAKE MAINTENANCE AND ASSEMBLY TOOL SET IN A HANDY CARRYING CASE.
- BRAKE SPRING PLIERS WITH MOVABLE CLAW FOR RIVETED AND GLUED BRAKE LININGS.
- BRAKE SPRING PLIERS FOR INSTALLING AND REMOVING THE BRAKE SHOE RECUPERATING SPRING ON RIVETED BRAKE LININGS.
- BRAKE CALLIPER BRUSH FOR REMOVAL OF BRAKE DUST AND DIRT FROM THE BRAKE CALLIPER.
- BRASS BRAKE CALLIPER BRUSH FOR CLEANING ALUMINIUM BRAKE CALLIPERS - SOFT BRASS BRISTLES FACILITATE DAMAGE-FREE CLEANING.
- SPECIAL TOOL FOR BRAKES FOR INSTALLING AND REMOVING SPRING PLATES AND THE HOLDING DEVICE OF BRAKE LININGS ON DRUM BRAKES, E.G. ON VW, SEAT, SKODA, OPEL AND RENAULT WITH REAR DRUM BRAKES.
- BRAKE CALLIPER FILE, EXTRA SLIM STYLE (WIDTH 10 MM), ESPECIALLY APPROPRIATE FOR JAPANESE VEHICLES, FOR REMOVAL OF BRAKE DUST, RUST AND DIRT FROM THE BRAKE CALLIPER.
- BRAKE LINE FLARE NUT WRENCH FOR SCREWED CONNECTIONS ON BRAKE LINES AT THE FRONT AND REAR AXLE, STRAIGHT SLOT WITH 10X11 6-POINT.
- ASSEMBLY TOOL FOR INSTALLING AND REMOVING THE DRAW SPRING OF HAND BRAKE SHOES, E.G. ON MERCEDES-BENZ PASSENGER CARS WITH REAR DISC BRAKES AS WELL AS ON VW LT SINCE 1997.
- BRAKE SPRING INSTALLER FOR PRESSURE SPRING OF THE PARKING BRAKE, BRAKE CABLE PLIERS FOR REMOVING AND REPLACING THE HAND BRAKE CABLE. THE PLIERS COMPRESS THE RETURN SPRINGS THAT FAR THAT THE CABLE CAN BE EASILY REMOVED AND REPLACED.

805007



TERMINAL RELEASE TOOL SET 16-PCS

- THESE TOOLS ARE SPRING LOADED TO ASSIST THE REMOVAL ON CITROEN, PEUGEOT AND RENAULT VEHICLES
 - SIMPLY PULL THE TOOL AND BEND, RELEASING THE SIDE LOCKING SLOT
 - FOR DAMAGE FREE RELEASING OF PLUG TYPE CONNECTORS WITH FOLDING/SHEATHS TO PROTECT THE USER AND THE FINE PRECISION TIPS
 - BLOW MOULD CASE SUPPLIED WITH POSITIONAL INSERT FOR EASY IDENTIFICATION OF MISSING TOOLS

ART.NO.	NO.	DESCRIPTION	SUITABLE FOR
805007-1	CE-01 CE-11	EJECTION TOOLS FOR CONTACT SIZES Ø 1.5 MM W/DISMANTLING SLEEVES FOR CONTACT SIZES	BMW, DAIMLER, FIAT, MAN, OPEL, PORSCHE, SEAT, SKODA, VW/AUDI
805007-2	CE-02 CE-12	EJECTION TOOLS FOR CONTACT SIZES Ø 3.5 MM W/DISMANTLING SLEEVES FOR CONTACT SIZES	BMW, DAIMLER, FIAT, MAN, OPEL, PORSCHE, SEAT, SKODA, VW/AUDI
805007-3	CE-05 CE-15	EJECTION TOOLS FOR CONTACT SIZES Ø 2.3 MM W/DISMANTLING SLEEVES FOR CONTACT SIZES	FORD, OPEL, PSA, RENAULT
805007-4	CE-53	CABLE EXTRACTOR TOOL FOR PLUGS WITH ONE RELEASE CHANNEL 2.8 AND 5.8 MM	BMW, DAIMLER, FORD, MAN, OPEL, PORSCHE, PSA, RENAULT, SEAT, SKODA, VW/AUDI
805007-5	CE-54	CABLE EXTRACTOR TOOL FOR PLUGS WITH ONE RELEASE CHANNEL 2.8 MM	BMW, PSA, RENAULT
805007-6	CE-56	CABLE EXTRACTOR TOOL FOR MICRO-TIMER II, III CONTACTS Ø 1.6 MM	DAIMLER, OPEL, PORSCHE, PSA, RENAULT, SAAB, SEAT, SKODA, VW/AUDI
805007-7	CE-56-1	FOR FLAT PLUG-IN SOCKETS WITH ASYMMETRICALLY POSITIONED LATCHES IN TERMINALS WITH TWO RELEASE CHANNELS	SEAT, SKODA, VW/AUDI.
805007-8	CE-57	FOR FLAT PLUG-IN SOCKETS WITH ASYMMETRICALLY POSITIONED LATCHES IN TERMINALS WITH TWO RELEASE CHANNELS	SEAT, SKODA, VW/AUDI
805007-9	CE-58	FOR FLAT PLUG-IN SOCKETS WITH ASYMMETRICALLY POSITIONED LATCHES IN TERMINALS WITH TWO RELEASE CHANNELS	SEAT, SKODA, VW/AUDI
805007-10	CE-59	CABLE EXTRACTOR TOOL FOR MAXI-POWER TIMER CONTACTS 9.5 MM	DAIMLER, VW/AUDI
805007-11	CE-62	CABLE EXTRACTOR TOOL FOR PIT-POD CONTACTS	ALL VEHICLE MAKES
805007-12	CE-74	CABLE EXTRACTOR TOOL FOR MICRO-TIMER I CONTACTS AND ABS PLUG-IN HOUSING Ø 1.6 MM	FIAT, FORD, MAZDA, OPEL, PSA, RENAULT, SAAB, VW/AUDI
805007-13	CE-91	CABLE EXTRACTOR TOOL FOR PLUGS WITH TWO RELEASE CHANNELS 2.8 AND 5.8 MM	BMW, DAIMLER, FIAT, FORD, MAN, OPEL, PSA, RENAULT, SAAB, VW/AUDI

805013



AIR CONDITIONER TOOL SET, 12-PCS

CONTAINS ALL TOOLS FOR FITTINGS ON AIR CONDITIONING SYSTEMS

ART. NO.	PCS	DESCRIPTION
805013-1...2	2	SPECIAL SOCKETS FOR 2,2, 3,2MM
805013-3...4	2	SPECIAL 8-SIDED SOCKETS 12, 15MM
805013-5...11	7	BIT ADAPTER AND 5-STAR BITS IP10H, IP15H, IP20H, IP25H, IP27H, IP30H, IP40H
805013-12	1	HOLE TO LOOSEN FLANGES ETC.
805013-13	1	ALL TOOLS WITH 6,3MM (1/4") DRIVE

819008



VALVE SPRING COMPRESSOR SET

- TO REMOVE AND INSTALL THE VALVE SPRING WITH THE CYLINDER HEAD ON OR OFF THE OHV & OHC PETROL OR DIESEL ENGINES.
- AN IDEAL TOOL KIT FOR MOST OF ENGINES.
- THE MULTI-POINT ADJUSTABLE BASE OF THIS TOOL BOLTED SECURELY TO THE HEAD WHILE THE ADJUSTABLE LEVER MECHANISM PIVOTS FORM THE BEAM. THUS, COMPRESS THE SPRING QUICKLY BY ONE HAND OPERATION.
- FAST REMOVE AND INSTALL OF THE SPRING RETAINING KEEPER. THEN EASILY ACCOMPLISHED THROUGH THE LARGE OPEN ON BOTH SIDES OF THE COMPRESSING TUBE.

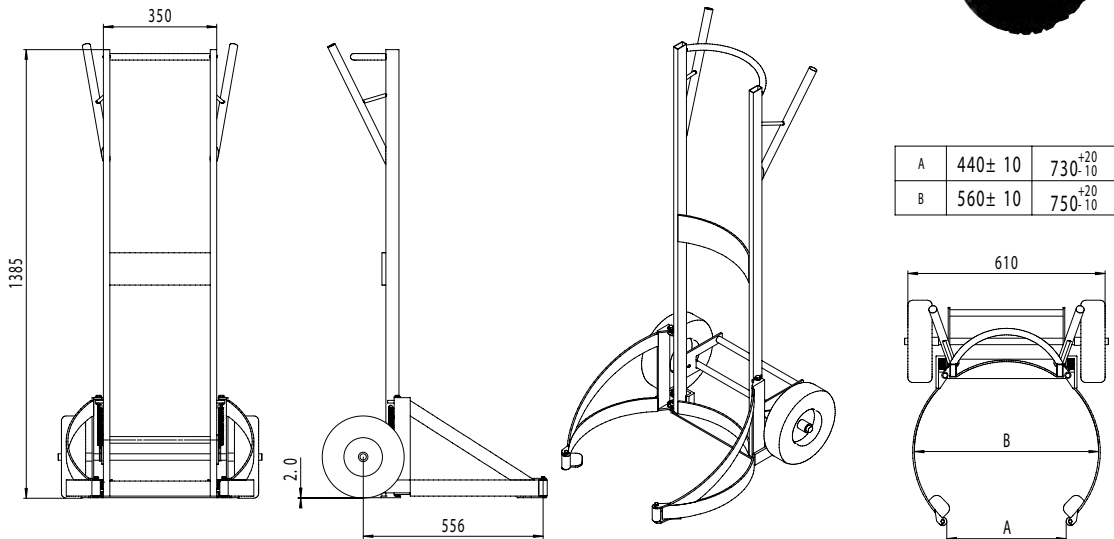

TYRE CARRIER CADDY

THIS LONG LIFE, LIGHT WEIGHT, HIGH CAPACITY CART ALLOWS THE TIRE FITTER TO MANEUVER HEAVY WHEEL SETS IN THE MOST ERGONOMIC WAY WITH THE HELP OF ITS PATENTED LIFTING SYSTEM. THE UNIQUE PUSH-SLIDE-SECURE AUTOMATIC LOCKING SYSTEM ELIMINATES THE NEED FOR INEFFICIENT, WEAR SENSITIVE, FOOT OPERATED - OR HAND CONTROLLED JAWS. THE LIGHT YELLOW COLORED FOAM FILLED TIRES ARE MAINTENANCE FREE AND LEAVE NO TRACES ON THE WORK SHOP FLOOR. THE WHEELS RUN ON INDUSTRIAL BEARINGS. IT COMES IN STAINLESS STEEL (ROBOTIC WELDING) WITH HIGH STRENGTH COMPONENTS AND AN EXCEPTIONAL 3 YEAR WARRANTY PERIOD. WITH JUST 17KG THIS LIGHTWEIGHT CART HANDLES WHEELS FROM 13"-20" UP TO 200KG.

47026



4822010



CABLE REEL 15 METER

- THE REEL CAN BE MOUNTED ON THE WALL OR CEILING AND SWIVEL 180°
- THE HOSE RETRACTS AUTOMATICALLY AND EVENLY
- A LATCH MAKES THE HOSE REWIND ONLY WHEN YOU WANT AND A SAFE LOCK OFFERS ADDITIONAL PROTECTION AGAINST ACCIDENTAL REWINDING

CABLE CORE:	COPPER
CABLE TYPE:	PVC, RUBBER
ØMM²:	3Gx1.5mm²
INPUT LINE:	15M
OUTPUT LINE:	1M
VOLTAGE/ FREQUENCY:	AC250V/50HZ
APPROVAL:	CE
CARTON SIZES:	555X345X355MM

AIR HOSE REEL 10 METER

- THE REEL CAN BE MOUNTED ON THE WALL OR CEILING AND SWIVEL 180°
- THE HOSE RETRACTS AUTOMATICALLY AND EVENLY
- A LATCH MAKES THE HOSE REWIND ONLY WHEN YOU WANT AND A SAFE LOCK OFFERS ADDITIONAL PROTECTION AGAINST ACCIDENTAL REWINDING

CASE MATERIAL:	PP
INPUT LINE:	10M
OUTPUT LINE:	1M
HOSE MATERIAL:	PU
HOSE DIAMETER:	8" 12MM
FITTING:	1/4" BSP
WORKING/ BURST PRES-SURE:	8/24 BAR
TEMPERATURE:	-5/-10 TO 45/50°C
CARTON SIZES:	555X345X355MM

47027



4822015



CABLE REEL 20 METER

- THE REEL CAN BE MOUNTED ON THE WALL OR CEILING AND SWIVEL 180°
- THE HOSE RETRACTS AUTOMATICALLY AND EVENLY
- A LATCH MAKES THE HOSE REWIND ONLY WHEN YOU WANT AND A SAFE LOCK OFFERS ADDITIONAL PROTECTION AGAINST ACCIDENTAL REWINDING

CABLE CORE:	COPPER
CABLE TYPE:	PVC, RUBBER
ØMM²:	3Gx1.5mm²
INPUT LINE:	20M
OUTPUT LINE:	1M
VOLTAGE/ FREQUENCY:	AC250V/50HZ
APPROVAL:	CE
CARTON SIZES:	615X365X355MM

AIR HOSE REEL 15 METER

- THE REEL CAN BE MOUNTED ON THE WALL OR CEILING AND SWIVEL 180°
- THE HOSE RETRACTS AUTOMATICALLY AND EVENLY
- A LATCH MAKES THE HOSE REWIND ONLY WHEN YOU WANT AND A SAFE LOCK OFFERS ADDITIONAL PROTECTION AGAINST ACCIDENTAL REWINDING

CASE MATERIAL:	PP
INPUT LINE:	15M
OUTPUT LINE:	1M
HOSE MATERIAL:	PU
HOSE DIAMETER:	8" 12MM
FITTING:	1/4" BSP
WORKING/ BURST PRES-SURE:	8/24 BAR
TEMPERATURE:	-5/-10 TO 45/50°C
CARTON SIZES:	615X365X355MM

47022



VOLT CIRCUIT TESTER 6-24V

ART. NO.	L(MM)	G	PCS/BAG
47022	110	32	1

- IDEAL FOR 6/12 AND 24 VOLT SYSTEMS ON CARS, MOTORCYCLES AND COMMERCIAL VEHICLES.
- WILL TEST FOR LIVE WIRES, BROKEN WIRES, BAD FUSES, BRAKE LIGHTS ETC.
- THE LIGHT IN THE HANDLE WILL GLOW IF WIRE IS LIVE.
- THE TESTER HAS A PROTECTIVE COVER OVER A NEEDLE PROBING POINT TO ENABLE YOU TO PIERCE THE INSULATED SHEATH AND MAKE CONTACT WITH THE COPPER CONDUCTOR BELOW TO TEST FOR BROKEN CABLES.

47025



KNEE PAD

MEASUREMENTS: 475X235X30MM

47019



AUTOMOTIVE MULTITESTER

SPECIFICATIONS

- CHECKS INTERIOR AND EXTERIOR LIGHTS
- CHECKS RELAYS AND POWER WINDOWS
- TEST POWER WINDOWS AND ELECTRIC MOTORS
- POWER SUPPLY FUNCTION WHEN TESTING SHORTED OR OVERLOADED CIRCUITS
- FINDS OPEN OR DISCONNECTED PARTS
- TEST THE POSITIVE AND NEGATIVE VOLTAGE
- TESTS CONTINUITY IN SWITCHES, RELAYS, DIODES, & FUSES, AND WIRING HARNESSSES
- POLARITY TEST CABLES AND SOCKETS
- FIND SHORT CIRCUITS AND BAD EARTHS FAST

ALSO AVAILABLE IN DISPLAY WITH 4 PIECES

48217...



NITRILE COATED GLOVE

- NYLON WITH NITRILE COATING.
- THE NITRILE COATING IS FLUIDS RESISTANCE.
- FOR BETTER FIT AND MORE COMFORT, ONLY THE GRIPPING PART IS COATED.
- BREATHABLE AND AN ERGONOMIC FIT DUE TO PARTLY COATED FINGER TIPS
- EN388 AND 3142 EUROPEAN STANDARDS.

ART. NO.	SPECIFICATION
4821701	NITRILE COATED GLOVE SIZE 8 (MEDIUM)
4821702	NITRILE COATED GLOVE SIZE 9 (LARGE)
4821703	NITRILE COATED GLOVE SIZE 10 (EXTRA LARGE)

48215...



TIE RAPS

ART. NO.	DESCRIPTION
4821511	TIE RAP 3,6X140; 100-PCS IN BAG (BLACK)
4821512	TIE RAP 3,6X180; 100-PCS IN BAG (BLACK)
4821513	TIE RAP 4,8X190; 100-PCS IN BAG (BLACK)
4821514	TIE RAP 4,8X220; 100-PCS IN BAG (BLACK)
4821515	TIE RAP 4,8X280; 100-PCS IN BAG (BLACK)
4821516	TIE RAP 4,8X330; 100-PCS IN BAG (BLACK)
4821517	TIE RAP 4,8X370; 100-PCS IN BAG (BLACK)

47017



DIGITAL MULTIMETER IN COMPACT SIZE

- WALL-MOUNTABLE CHARGING UNIT
- LED INDICATOR
- HIGH QUALITY SPRING AUTO RETRACTABLE SYSTEM
- ROBUST BODY

FEATURES	SPECIFICATIONS
- 3 1/2 DIGITS LCD (MAX. READING 1999)	- VOLTAGE DC: 200M/2/20/200/600V
- LOW BATTERY INDICATION	- VOLTAGE AC: 200/600V
- OVERLOAD PROTECTION	- CURRENT DC: 2M/20M/200M/10A
- AUDIBLE CONTINUITY	- RESISTANCE: 200-2K-20K-200K-2000K
	- BATTERY CHECK: 1.5V, 9V
	- CONTINUITY: YES
	- DIODE CHECK: 2.8V/1MA
	- POWER SOURCE: 9V BATTERY (NEDA 6F22) X1
	- DIMENSIONS: 127X66X26MM
	- WEIGHT: 106G (WITH BATTERY)

ALSO AVAILABLE IN DISPLAY WITH 6 PIECES

47018



3 IN 1 DIGITAL MULTIMETER

SONIC DIGITAL MULTIMETER WITH BACKLIGHT. MEASURING DC/AC, VOLTAGE, DC CURRENT AND RESISTANCE.

FEATURES	SPECIFICATIONS
- LCD DISPLAY (MAX. READING 3999)	- VOLTAGE DC: 0.4/4/40/400/600V
- 3/4 BACKLIGHT FUNCTION	- VOLTAGE AC: 4/40/400/600V
- AUTO POLARITY INDICATION	- CURRENT DC: 400µ/4000µ/40M/400M/10A
- MANUAL RANGE AND AUTO RANGE MODE	- CURRENT AC: 400µ/400µ/40M/400M/10A
- AUTO/MANUAL POWER OFF	- RESISTANCE: 400/4K/40K/400K/4M/40Mµ
- RELATIVE MODE	- CAPACITANCE: 4N/40N/400N/4µ/40µ/100µF
- OVERLOAD PROTECTION	- FREQUENCY: 10/100/1K/10K/100K/200KHZ
- LOW BATTERY INDICATION	- DUTY CYCLE: 5%-95%
	- TEMPERATURE: -20°C - 1000°C
	- CONTINUITY: YES
	- DIODE CHECK: YES
	- POWER SOURCE: 9V BATTERY (6F22)
	- DIMENSIONS: 162X83X47MM
	- WEIGHT: 310G (WITH BATTERY)

ALSO AVAILABLE IN DISPLAY WITH 3 PIECES



1. Power unit
2. Serial Number
3. Storage case (not shown)
4. Model number
5. Cord and Plug 230v AC
6. Vent (end)
7. Preformed Coil - 19mm
8. Preformed Coil - 22mm
9. Universal rope coil
10. Body-Pad (option)
11. Owners Manual (not shown)
12. Power Switch
13. Coil Location Socket
14. Thumb Screw
15. LED

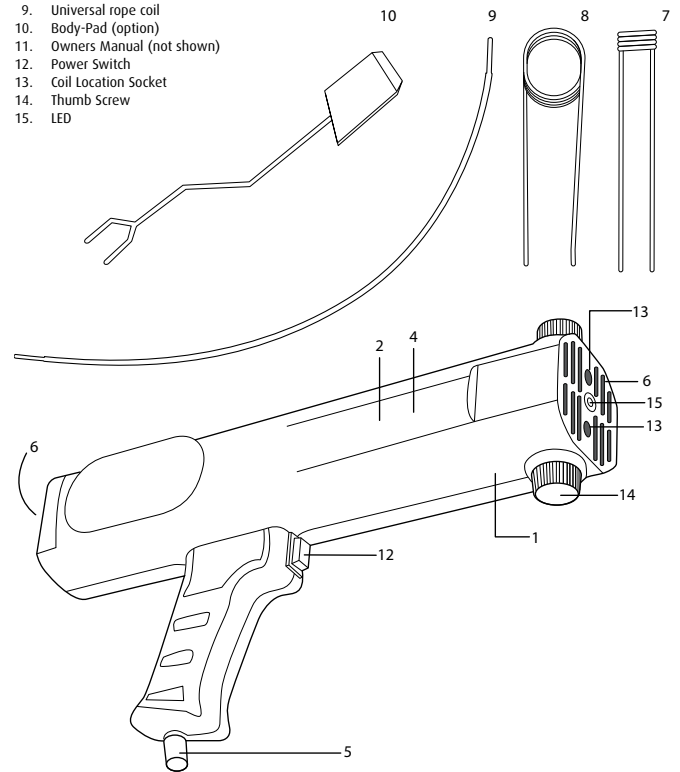

ART. NO.	CONTENTS
47029-1	STANDARD COIL 15MM FOR HEAT INDUCTOR
47029-2	STANDARD COIL 19MM FOR HEAT INDUCTOR
47029-3	STANDARD COIL 22MM FOR HEAT INDUCTOR
47029-4	STANDARD COIL 26MM FOR HEAT INDUCTOR
47029-5	STANDARD COIL 32MM FOR HEAT INDUCTOR
47029-6	STANDARD COIL 38MM FOR HEAT INDUCTOR
47029-7	STANDARD COIL 45MM FOR HEAT INDUCTOR
47029-8	EXTRA LONG COIL 15MM FOR HEAT INDUCTOR
47029-9	EXTRA LONG COIL 19MM FOR HEAT INDUCTOR
47029-10	EXTRA LONG COIL 22MM FOR HEAT INDUCTOR
47029-11	EXTRA LONG COIL 26MM FOR HEAT INDUCTOR
47029-12	EXTRA LONG COIL 32MM FOR HEAT INDUCTOR
47029-13	EXTRA LONG COIL 38MM FOR HEAT INDUCTOR
47029-14	SELF FORMING COIL FOR HEAT INDUCTOR
47029-15	ROPE COIL FOR HEAT INDUCTOR
47029-16	EXTRA LONG COIL 45MM FOR HEAT INDUCTOR

HEAT INDUCTOR GUN

HEAT INDUCTOR GUN

THE HEAT INDUCTOR USES INDUCTION TECHNOLOGY TO CREATE FLAMELESS HEAT. THIS ACCURATELY CONCENTRATES THE HEAT INTO THE AREA YOU ARE WORKING ON, ONLY HEATING THE METAL OR TREATED PLASTICS. THE KEY BENEFIT OF THIS IS THAT IT MINIMISES THE RISK OF COLLATERAL DAMAGE AND REDUCES 'COOL OFF' PERIODS SAVING THE WORKSHOP TIME AND MONEY. IT IS AN INVALUABLE TOOL FOR WORKING WITH EASILY DAMAGED COMPONENTS SUCH AS BODY TRIM AND WINDSCREEN SURROUNDS. THE MAGNETIC FIELD PASSES THROUGH NON-METALS SUCH AS GLASS AND TRIM AND HEATS THE METAL UNDERNEATH. IDEAL FOR TRACK ROD ENDS, EXHAUSTS AND FOR ANY SEIZED NUTS AND BOLTS. SUPPLIED WITH ONE OF EACH 22MM COIL, 19MM COIL, UNIVERSAL ROPE COIL

- 240V 13AMP MAINS POWERED HAND HELD HEAT INDUCTOR
- USES INDUCTION TECHNOLOGY TO GENERATE HEAT QUICKLY IN FERROUS (IRON) COMPONENTS
- NO FLAME OR FLAMMABLE LIQUIDS OR GASES USED
- HEAT QUICKLY TO SMALL OR MEDIUM SIZE AREA (COIL DEPENDENT)
- SUPPLIED WITH A SELECTION OF COIL SIZES AND SHAPES
- IS FASTER, SMALLER AND MORE PRECISE THAN AN OXY-ACETYLENE TORCH SYSTEM
- CAN HEAT A 3/4" NUT IN LESS THAN 15 SECONDS
- REDUCES 'COOL DOWN' PERIODS GIVING A VALUABLE TIME SAVING FOR BUSY WORKSHOPS
- POTENTIALLY GIVES CHEAPER LIABILITY INSURANCE DUE TO LESS RISK THAN USE OF OPEN FLAMES
- IS CHEAPER TO RUN THAN GAS TORCH SYSTEMS
- HAS DIFFERENT COIL TYPES TO HELP IT REACH VIRTUALLY ANY DIFFICULT TO REACH AREA
- HAS NO NEED FOR SPECIALIST TRAINING
- HAS AN ERGONOMICALLY DESIGNED 'PISTOL GRIP' HANDLE FOR EASE OF USE
- HAS A BRIGHT LED LAMP TO ILLUMINATE THE WORK AREA

THE HEAT INDUCTOR GUN CAN BE USED TO:

- THE REMOVAL OF SEIZED AND CORRODED COMPONENTS
- NUTS AND BOLTS
- TRACK ROD ENDS
- EXHAUST CLAMPS
- MANIFOLD NUTS/BOLTS
- BEARING HOUSINGS
- STEERING AND SUSPENSION
- BEARINGS, GEARS AND PULLEYS AND MANY MORE

REPAIRS

- FREING OFF WHEEL NUTS WITHOUT THE RISK OF EXPENSIVE WHEEL DAMAGE (WHERE ACCES PERMITS)
- HAIL DENT REMOVAL
- BODY TRIMS
- WINDSCREEN SURROUNDS
- GENERALLY ANYTHING THAT WOULD TRADITIONALLY REQUIRE USE OF A BLOWTORCH OR SIMILAR FLAME PRODUCING TOOL

4822301



E-CIRCLIP SET 300-PCS

30X 1.5MM
50X 6.0MM
20X 15MM
30X 3.0MM
50X 10MM
20X 19MM
40X 5.0MM
40X 12MM
20X 22MM

4822305

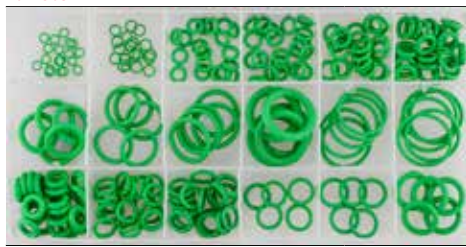

O-RING ASSORTMENT 225-PCS

20X:
03 X 1, 04 X 1, 04.5 X 2,
05 X 2, 06 X 2, 06 X 2.5,
06 X 3, 07 X 2, 08 X 2MM
5X:
09 X 2, 010 X 2, 012 X 3,
013 X 3, 014 X 2.5, 017 X 2.5,
018 X 4, 020 X 2, 022 X 2MM

4822309



CIRCLIP ASSORTMENT 300-PCS

20X 03MM **15X** 011MM **15X** 020MM
10X 04MM **15X** 012MM **20X** 022MM
15X 05MM **25X** 013MM **15X** 025MM
25X 06MM **15X** 014MM **15X** 026MM
15X 08MM **20X** 015MM **10X** 028MM
20X 09MM **25X** 019MM **5X** 032MM

4822302



SHRINKING HOSE ASSORTMENT 127-PCS

20X 02.0 X 40MM
16X 07.0 X 80MM
25X 02.5 X 40MM
8X 010.0 X 80MM
20X 03.5 X 40MM
8X 013.0 X 85MM
20X 05.0 X 40MM

4822306



SNAP RING ASSORTMENT 300-PCS

20X 03MM **15X** 011MM **15X** 020MM
10X 04MM **15X** 012MM **20X** 022MM
15X 05MM **25X** 013MM **15X** 025MM
25X 06MM **15X** 014MM **15X** 026MM
15X 08MM **20X** 015MM **10X** 028MM
20X 09MM **25X** 019MM **5X** 023MM

4822310



ASSORTMENT OF SEALING RINGS 150-PCS

1MM THICK:
10X: 5 X 10, 6 X 10, 7 X 10, 8 X 12, 10 X 16MM
1.5MM THICK:
10X: 10.5 X 17, 11 X 17, 12 X 10, 12.5 X 20, 14 X 18, 14 X 20MM
2MM THICK:
10X: 15 X 20MM, 16 X 22MM, 16.5 X 24MM, 17.5 X 24MM

4822303

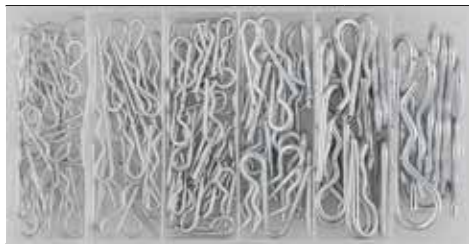

W-CLIP ASSORTMENT 150-PCS

30X 2.0 X 33MM
25X 2.8 X 41MM
25X 2.0 X 40MM
20X 3.6 X 44MM
42X 2.4 X 30MM
8X 4.0 X 75MM

4822307

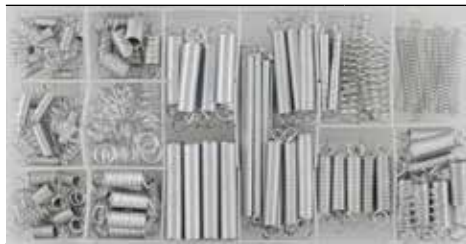

ASSORTMENT OF TENSILE AND COMPRESSION SPRINGS 200-PCS

COMPRESSION SPRINGS:
5.5 X 17.5, 5.5 X 38.0, 6.5 X 10.0,
7.0 X 12.5, 7.0 X 19.0, 9.0 X 35.0,
9.5 X 16.0, 9.5 X 19.0MM
TENSILE SPRINGS:
4.0 X 79.5, 4.5 X 44.5, 5.0 X 20.5,
5.5 X 25.5, 6.5 X 22.0, 7.0 X 98.0,
7.0 X 51.0, 8.0 X 28.5, 8.0 X 31.5,
8.0 X 44.5, 8.5 X 36.5, 8.5 X 47MM

4822311

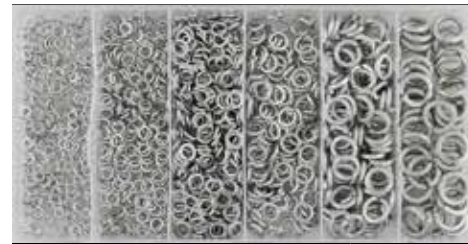

ASSORTMENT OF SYNCHRONISER RINGS 1200-PCS

300X: 03, 04, 05MM
150X: 06MM
100X: 08MM
50X: 010MM

4822304



SEAL ASSORTMENT 141-PCS

RUBBER:
5X: 08 X 014 X 4, 08.5 X 018 X 4, 09.5 X 017.5 X 4, 010.5 X 014 X 4MM
10X: 04 X 016 X 4, 04 X 017 X 4, 012 X 024 X 2, 015 X 024 X 3MM
FIBRE:
5X: 027 X 033 X 1.2MM
10X: 010 X 013.5 X 1.8, 011.5 X 017.5 X 1.2, 017 X 021 X 1.2MM
017 X 024 X 1.2, 020 X 025 X 1.2MM
EVA:
3X: 027 X 038 X 2, 030 X 039 X 2MM
10X: 012 X 017.5 X 2, 017 X 024 X 2MM

4822308



ASSORTMENT OF PINS 555-PCS

150X 1.6 X 25MM
75X 3.2 X 32MM
150X 2.5 X 25MM
50X 3.2 X 50MM
100X 2.4 X 38MM
30X 4.0 X 64MM

4822312



HOLLOW PIN/ASSORTMENT OF SYNCHRONISER RINGS 450-PCS

150X 02X20MM **30X** 05X40MM **8X** 40MM
80X 03X30MM **5X** 05X50MM **4X** 50MM
30X 03X40MM **5X** 05X60MM **4X** 60MM
40X 04X30MM **20X** 06X40MM **3X** 80MM
20X 04X40MM **5X** 06X50MM **2X** 40MM
30X 04X50MM **4X** 06X60MM **6X** 80MM
4X 07X70MM

4822313



HOSE CLAMP SET 26-PCS

- 8X Ø16MM
- 2X Ø28MM
- 6X Ø22MM
- 2X Ø35MM
- 4X Ø25MM
- 4X Ø40MM

4822317



ASSORTMENT OF AUTOMOTIVE FUSES 121-PCS

- 20X 5A
- 20X 10A
- 20X 15A
- 20X 20A
- 20X 25A
- 20X 30A
- 1X FUSE REMOVAL TOOL

4822321



ASSORTMENT RUBBER GROMMET 180-PCS

- 40X 1/4" (6.3MM)
- 20X 1/2" (12.5MM)
- 40X 5/16" (7.9MM)
- 5X 5/8" (15.9MM)
- 40X 3/8" (9.5MM)
- 5X 7/8" (22.2MM)
- 25X 7/16" (11.1MM)
- 5X 1" (25.4MM)

4822314

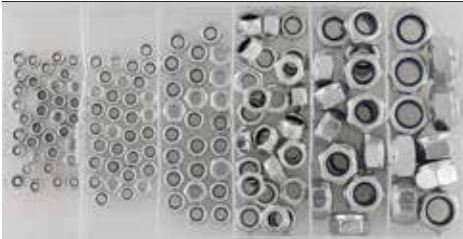

ASSORTMENT OF NUTS 146-PCS

- 35X M4 X P0.7
- 25X M8 X P1.25
- 35X M5 X P0.8
- 16X M10 X P1.5
- 25X M6 X P1.0
- 10X M12 X P1.75

4822318



QUICK-ACTION CONNECTOR SET 50-PCS

- 25X CONNECTORS FOR 0.5-1.5MM² CABLE CROSS-SECTION
- 25X CONNECTORS FOR 1.5-2.5MM² CABLE CROSS-SECTION

4822322



O-RING ASSORTMENT 225-PCS

- 20X: Ø3X1, Ø4X1, Ø4.5X2, Ø5.2, Ø6X2, Ø6X2.5, Ø6X3, Ø7X2, Ø8X2MM
- 5X: Ø9X2, Ø10X2, Ø12X3, Ø13X3, Ø14X2.5, Ø17X2.5, Ø18X4, Ø20X2, Ø22X2MM

4822315



ASSORTMENT OF BODY BOLTS AND SPEED NUTS 170-PCS

- CROSS-SLOT SCREWS:**
- 40X: M3X8MM 20X: M4X16MM
- 15X: M5X12MM 10X: M6X20MM
- SPEED NUTS:**
- 20X: M3 20X: M3 (WITH NOTCH)
- 20X: M4 15X: M5
- 10X: M6

4822319



BLIND RIVET ASSORTMENT 400-PCS

- 100X Ø2.4X37MM
- 100X Ø4.0X37MM
- 100X Ø3.2X37MM
- 100X Ø4.8X37MM

4822323

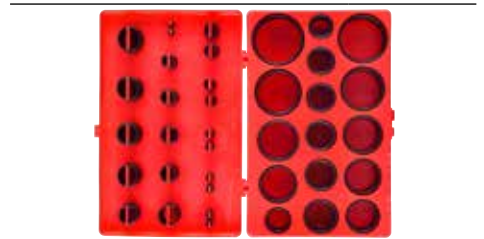

O-RING ASSORTMENT 419-PCS

- Ø3X1.5, Ø4.4X2, Ø5X2, Ø7X1.5MM
- Ø10X1.5, Ø10X2.5, Ø11X2.5, Ø13X1.5MM
- Ø13X2.5, Ø14X2.5, Ø16X2.5, Ø18X2.5MM
- Ø18X3.5, Ø19X2.5, Ø20X3.5, Ø21X2.5MM
- Ø22X2.5, Ø22X3.5, Ø23.5X3.5, Ø 25X3.5MM
- Ø26.5X3.5, Ø28X3.5, Ø30X3.5, Ø31X3.5MM
- Ø33X3.5, Ø34.5X3.5, Ø36X3.5, Ø38X3.5MM
- Ø41X3.5, Ø44X3.5, Ø47X3.5, Ø50X3.5MM

4822316



ASSORTMENT OF CROCODILE CLIPS 28-PCS

- 10X 50MM (MINI)
- 6X 65MM
- 6X 55MM
- 2X 70MM
- 2X 60MM
- 2X 80MM

4822320



GREASE NIPPLE ASSORTMENT 110-PCS

- 60X M6 X P1.0
- 10X M8 X P1.25
- 10X M10 X P1.5
- 5X M6 X P1.0/45°
- 5X M8 X P1.25/45°
- 5X M10 X P1.5/45°
- 5X M6 X P1/90°
- 5X M8 X P1.25/90°
- 5X M10 X P1.5/90°

4822324



ASSORTMENT OF BOLT, NUT & WASHER 240-PCS

- 10X M4X12MML 20X M4XP0.7 20X Ø4
- 10X M4X20MML 20X M5XP0.8 20X Ø5
- 10X M5X16MML 20X M6XP1.0 20X Ø6
- 10X M5X25MML 10X M8XP1.25 10X Ø8
- 10X M6X20MML 10X M10XP1.5 10X Ø10
- 10X M6X30MML 5X M8X25MML 5X M8X40MML
- 5X M10X40MML 5X M10X16MML

4822325



MINI AUTO FUSE ASSORTMENT 120-PCS

- 20X 5A
- 20X 10A
- 20X 15A
- 20X 20A
- 20X 25A
- 20X 30A

4822329



GLASS AUTO FUSE ASSORTMENT 120-PCS

- 20X 5A
- 20X 10A
- 20X 15A
- 20X 20A
- 20X 25A
- 20X 30A

4822335



AUTO FUSE ASSORTMENT 80-PCS

- 10X 3A
- 10X 5A
- 10X 7.5A
- 10X 10A
- 10X 15A
- 10X 20A
- 10X 25A
- 10X 30A

4822326



ASSORTMENT OF AUTOMOTIVE FUSES 120-PCS

- 20X 5A
- 20X 10A
- 20X 15A
- 20X 20A
- 20X 25A
- 20X 30A

4822330



ALUMINIUM WASHER ASSORTMENT 300-PCS

- 05X09X1.0 08X014X1.5 012X016X1.0MM
- 014X020X1.5 018X024X1.5 022X029X1.5MM
- 06X010X1.0 09X014X1.0 012X016X1.5MM
- 014X020X2.0 020X024.5X1.5 024X029X1.5MM
- 06X012X1.0 010X014X1.0 012X018X1.5MM
- 016X020X1.5 020X024.5X0.8 024X032X2.0MM
- 08X012X1.0 010X014X1.5 013X018X1.0MM
- 016X022X1.5 019X026X2.0 026X034X2.0MM
- 08X014X1.0 010X016X1.0 014X018X1.5MM
- 018X022X1.5 022X027X1.0 028X036X2.0MM

4822336



MINI AUTO FUSE ASSORTMENT 75-PCS

- 10X 2A
- 5X 3A
- 5X 4A
- 10X 5A
- 5X 7.5A
- 10X 10A
- 10X 15A
- 10X 20A
- 5X 25A
- 5X 30A

4822327

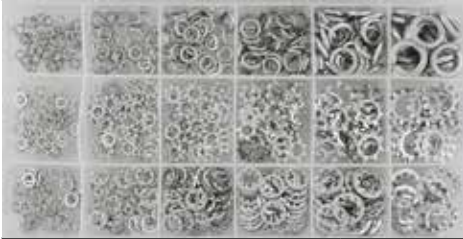

WASHER ASSORTMENT 720-PCS

- 50X: #6 C-TYPE, #6 STAR TYPE, #6 CIRCLE STAR TYPE #8 C-TYPE, #8 STAR TYPE, #8 CIRCLE STAR TYPE #10 C-TYPE, #10 STAR TYPE, #10 CIRCLE STAR TYPE
- 40X: 6.4MM C-TYPE, 6.4MM STAR TYPE, 6.4MM CIRCLE STAR TYPE
- 30X: 8.0MM C-TYPE, 8.0MM STAR TYPE, 8.0MM CIRCLE STAR TYPE
- 20X: 9.5MM C-TYPE, 9.5MM STAR TYPE, 9.5MM CIRCLE STAR TYPE

4822333



ASSORTED CRIMP TERMINALS, INSULATED 160-PCS

- 4X RV 5.5-5 & 5.5-8 & 5.5-10 YELLOW
- 5X MDD 5.5-250 & FDD 5.5-250 YELLOW
- 12X BV 5.5-5 YELLOW
- 10X RV 2-4L & 2-5L & 2-6 BLUE
- 10X MDD 2-250 & FDD 2-250 BLUE
- 10X MBB 2 & FBB 2 BLUE
- 10X SVL 2-4 BLUE
- 4X SCOTCHLOK BLUE
- 12X BV 2 BLUE
- 8X RVS 1.25-4 RED
- 4X SCOTCHLOK RED
- 18X BV 1.25 RED

4822337



DRAIN PLUG GASKET ASSORTMENT 60-PCS

- 10X 1/2" FIBER
- 10X 1/2" NYLON
- 10X 1/2" NYLON
- 10X 14MM NYLON
- 5X 12MM NYLON
- 5X 14MM FIBER
- 5X 18MM FIBER
- 5X 20MM FIBER

4822328



CLEVIS PIN ASSORTMENT 60-PCS

- 3MM HOLE: 05X25, 06X25, 06X30, 06X40MM, 06X45, 06X50, 06X60, 06X65MM, 08X25, 08X30, 08X40, 08X45MM, 08X50, 08X60, 08X65, 08X70MM
- 4MM HOLE: 010X25, 010X40, 010X50MM, 012X40, 012X50MM

4822334



MASTER PLUG-IN STYLE FUSE ASSORTMENT 118-PCS

- 3X MAXI 20A, 3X MAXI 30A, 3X MAXI 40A, 3X MAXI 50A, 3X MAXI 60A, 3X MAXI 80A
- 5X MINI 2A, 5X MINI 3A, 5X MINI 4A, 5X MINI 5A, 5X MINI 7.5A, 5X MINI 10A, 5X MINI 15A, 5X MINI 20A, 5X MINI, 5X MINI 30A
- 5X ATO 3A, 5X ATO 5A, 5X ATO 7.5A, 5X ATO 10A, 10X ATO 15A, 10X ATO 20A, 5X ATO 25A, 5X ATO 30A

4822338



GLASS AUTO FUSE ASSORTMENT 95-PCS

- 5X 5A
- 10X 10A
- 20X 15A
- 20X 20A
- 20X 25A
- 20X 30A

4822339



BUTT CONNECTOR ASSORTMENT 100-PCS

- 10X 22-18
- 10X 22-18
- 30X 16-14
- 30X 16-14
- 10X 12-10
- 10X 12-10

4822342



TRIM CLIP ASSORTMENT FOR NISSAN 408-PCS



4822345

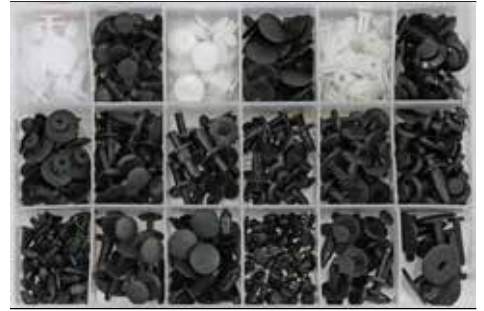

TRIM CLIP ASSORTMENT FOR FORD 415-PCS



4822340



SHRINK TUBE ASSORTMENT 85-PCS

- 20X 1/8"
- 15X 1/4"
- 20X 3/16"
- 10X 3/8"
- 15X 1/4"
- 05X 1/2"

4822343

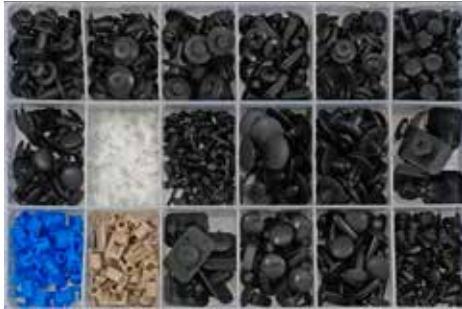

TRIM CLIP ASSORTMENT FOR MAZDA 475-PCS



4822346



TRIM CLIP ASSORTMENT FOR VOLKSWAGEN 255-PCS



4822341

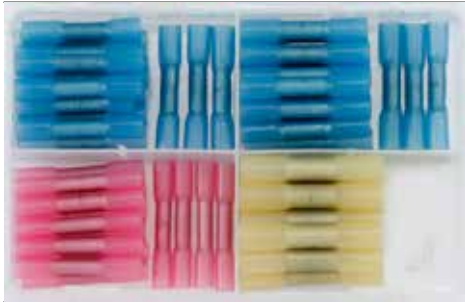

BUTT CONNECTOR ASSORTMENT WITH SHRINK TUBE 60-PCS

- 8X 22-18
- 7X 22-18
- 15X 16-14
- 15X 16-14
- 8X 12-10
- 7X 12-10

4822344



TRIM CLIP ASSORTMENT FOR MITSUBISHI 370-PCS



4822347



PLASTIC LOCKING NUT ASSORTMENT 350-PCS



4822348



TRIM CLIP ASSORTMENT FOR TOYOTA/ LEXUS 360-PCS



4822351



TRIM CLIP ASSORTMENT FOR PEUGEOT 345-PCS



4822354



TRIM CLIP ASSORTMENT FOR BMW 290-PCS



4822349



TRIM CLIP ASSORTMENT FOR RENAULT 300-PCS



4822352



TRIM CLIP ASSORTMENT FOR FIAT 308-PCS

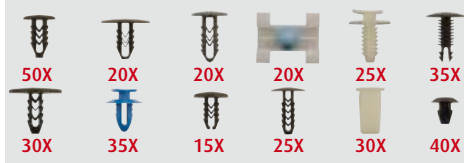

4822355



TRIM CLIP ASSORTMENT FOR MERCEDES BENZ 270-PCS



4822350



TRIM CLIP ASSORTMENT FOR VAUXHALL/ OPEL 300-PCS



4822353

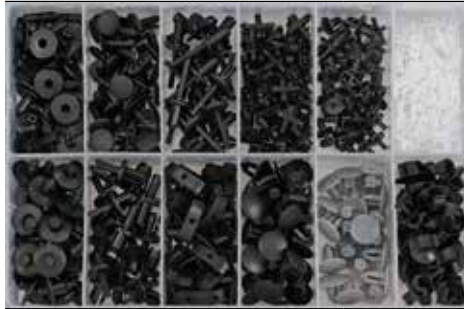

TRIM CLIP ASSORTMENT FOR VOLVO 350-PCS

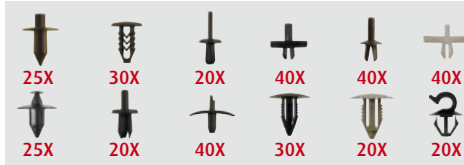

4822356



TRIM CLIP ASSORTMENT FOR AUDI 160-PCS



08

APART FROM BEING COMPETITIVELY PRICED, SONIC SPRING COMPRESSOR IS ONE OF THE MOST USER-FRIENDLY COIL SPRING COMPRESSORS ON THE MARKET, MAKING DISMANTLING OF MCPHERSON STRUTS SAFER, EASIER AND MUCH FASTER COMPARED TO USING A TRADITIONAL TOOL. SONIC SPRING COMPRESSOR IS SUPPLIED WITH TWO SETS OF STANDARD JAWS WHICH WORK EFFICIENTLY WITH THE SPRINGS ON APPROXIMATELY 90% OF ALL CARS



HANDWHEEL

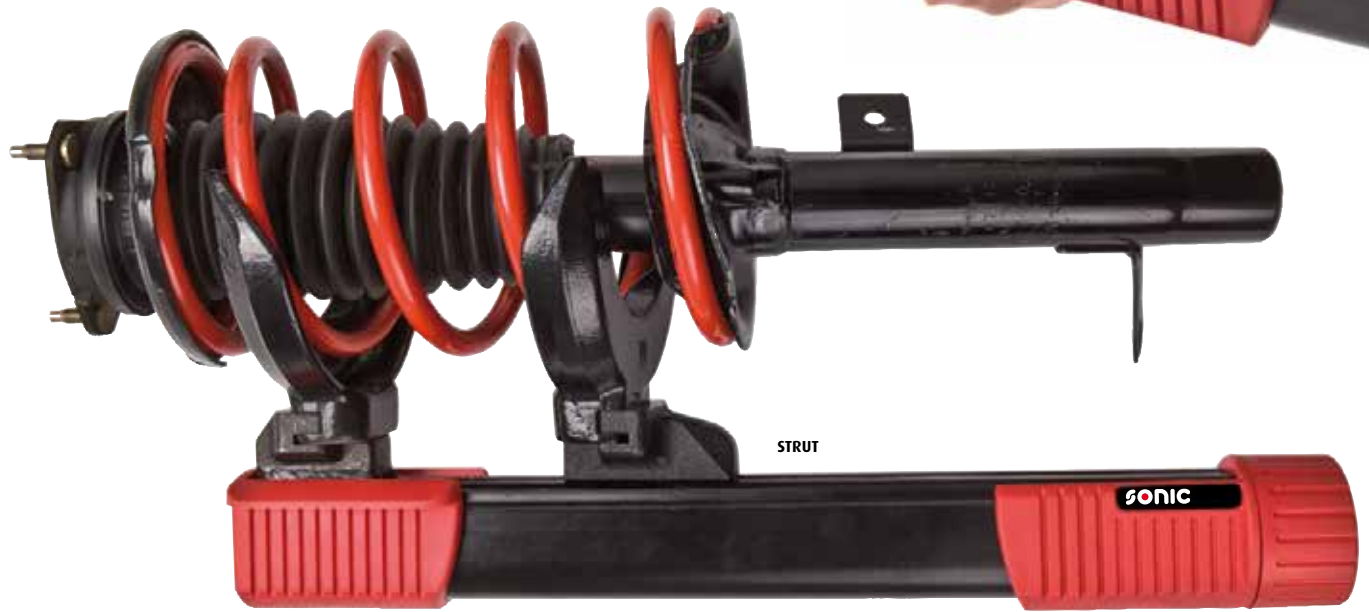

STRUT



JAWS



AIR WRENCH

SPRING COMPRESSOR 2250 KG

- HANDLES APPROXIMATELY 90% OF ALL CARS
- HIGH QUALITY COIL SPRING COMPRESSOR USED BY THOUSANDS OF PROFESSIONALS
- SUPPLIED WITH TWO SETS OF STANDARD JAWS
- BUILT-IN PROTECTIVE ACCESSORY
- LARGE USER-FRIENDLY ADJUSTING HANDLE
- TÜV APPROVED SAFETY

INNOVATIVE BUILT-IN PROTECTIVE ACCESSORY	ERGONOMIC HANDLES	TWO PAIRS OF STANDARD JAWS EASILY CHANGED	AIR WRENCH	SPECIFICATIONS	ACCESSORIES
<ul style="list-style-type: none"> - FOR SAFE AND EASY CLAMPING IN THE BENCH VICE - MADE FROM HIGH-TECH HARD-WEARING POLYURETHANE 	<ul style="list-style-type: none"> - LARGE USER-FRIENDLY AND ERGONOMIC ADJUSTING HANDLE - FOR EASIER AND FASTER MANUAL POSITIONING OF THE JAWS - ERGONOMIC HANDLE ON THE BODY MAKES THE TOOL MORE COMFORTABLE TO HOLD 	<ul style="list-style-type: none"> - JAWS SECURED WITH STRONG BOLTS - EQUIPPED WITH A LIP WHICH LOCKS THE SPRING DURING COMPRESSION IMPROVING SAFETY - POWDER COATED SURFACE TO PROTECT THE SPRINGS 	<ul style="list-style-type: none"> - CAN BE USED ON THE SPINDLE - TO AVOID OVERLOAD USE MAX. 180 NM AIR WRENCH 	<ul style="list-style-type: none"> - MAX LOAD 2250 KG - TWO SETS OF JAWS: 2 PIECES Ø 80-145MM AND 2 PIECES Ø 145-195MM - BUILT-IN SAFETY PIN - USE AIR WRENCH MAX 180 NM - MAX DISTANCE: 364 MM - MIN DISTANCE: 65 MM - WEIGHT BODY: 5.2KG - WEIGHT INCLUDED JAWS: 10.7 KG 	<p>JAWS FOR SPECIAL SPRINGS ARE AVAILABLE ON REQUEST</p>

120001

CE 

APART FROM BEING COMPETITIVELY PRICED AND MAKES THE DISMANTLING OF MCPHERSON STRUTS BOTH SAFER AND EASIER. IT IS VERY SIMPLE AND EASY TO USE THE SONIC SPRING COMPRESSOR AND COMPARED WITH USING A TRADITIONAL TOOL, MAKES THE OPERATION MUCH FASTER GIVING A CONSIDERABLE SAVING IN WORKING HOURS. SONIC SPRING COMPRESSOR IS SUPPLIED WITH TWO SETS OF STANDARD JAWS WHICH WORK EFFICIENTLY WITH THE SPRINGS ON APPROXIMATELY 90% OF ALL CARS.



SPRING COMPRESSOR 1500 KG

- HANDLES APPROXIMATELY 90% OF ALL CARS
- HIGH QUALITY COIL SPRING COMPRESSOR USED BY THOUSANDS OF PROFESSIONALS
- SUPPLIED WITH TWO SETS OF STANDARD JAWS
- TAILORED PROTECTIVE JAWS FOR CLAMPING THE BENCH VICE ARE ADDITIONAL ACCESSOIRES
- TUV APPROVED SAFETY

INNOVATIVE BUILT-IN PROTECTIVE ACCESSORY	TWO PAIRS OF STANDARD JAWS EASILY CHANGED	AIR WRENCH	SPECIFICATIONS	ACCESSORIES
<ul style="list-style-type: none"> - FOR SAFE AND EASY CLAMPING IN THE BENCH VICE - MADE FROM HIGH-TECH HARD-WEARING POLYURETHANE 	<ul style="list-style-type: none"> - JAWS SECURED WITH STRONG BOLTS - EQUIPPED WITH A LIP WHICH LOCKS THE SPRING DURING COMPRESSION IMPROVING SAFETY - POWDER COATED SURFACE TO PROTECT THE SPRINGS 	<ul style="list-style-type: none"> - CAN BE USED ON THE SPINDLE - TO AVOID OVERLOAD USE MAX. 180 NM AIR WRENCH 	<ul style="list-style-type: none"> - MAX LOAD 1500 KG - TWO SETS OF JAWS: 2 PIECES Ø 80-145MM AND 2 PIECES Ø 145-195MM - BUILT-IN SAFETY PIN - USE AIR WRENCH MAX 180 NM - MAX DISTANCE: 354 MM - MIN DISTANCE: 65 MM - WEIGHT BODY: 4.7KG - WEIGHT INCLUDED JAWS: 10.2 KG 	<p>JAWS FOR SPECIAL SPRINGS ARE AVAILABLE ON REQUEST.</p>

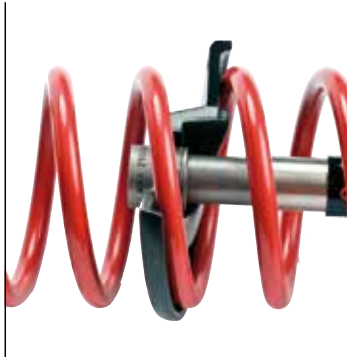
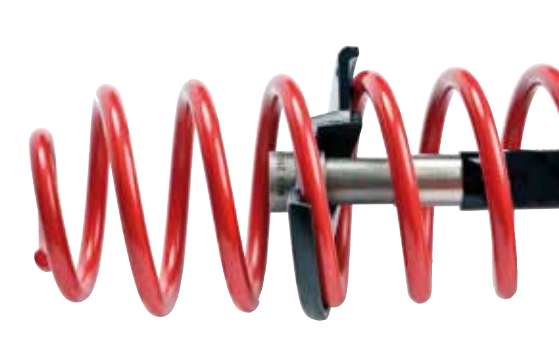

SPRING COMPRESSOR 1500KG

- HANDLES 95% OF ALL CARS WITH WISHBONE/MULTILINK SUSPENSION REAR AND FRONT
- ONLY TOOL ON THE MARKET CAPABLE OF HANDLING AMONG OTHERS VW TOURAN, CITROËN C3, SKODA OCTAVIA, AND PEUGEOT 107
- VERY COMPACT DESIGN MAKES IT POSSIBLE TO USE THE TOOL FOR CARS WITH A SMALL HOLE IN THE REAR SPRING CONTROL ARM DOWN TO Ø 30 MM
- UNIQUE SAFETY KEY TORQUE
- ONLY ON THE MARKET WITH ANGLED JAWS
- PATENT PENDING
- TÜV APPROVED SAFETY

INNOVATIVE ANGLED SHAPE OF THE JAWS	UNIQUE SAFETY KEY TORQUE	TWO PAIRS OF STANDARD JAWS EASILY CHANGED	SPECIFICATIONS	ACCESSORIES
<ul style="list-style-type: none"> - ONLY UNIVERSAL SPRING COMPRESSOR ON THE MARKET FOR WISHBONE/MULTILINK SUSPENSION WITH ANGLED JAWS - IMPROVES SAFETY - PROVIDES A HIGH DEGREE OF FUNCTIONALITY 	<ul style="list-style-type: none"> - ONLY UNIVERSAL SPRING COMPRESSOR ON THE MARKET FOR WISHBONE/MULTILINK SUSPENSION WITH ANGLED JAWS - IMPROVES SAFETY - PROVIDES A HIGH DEGREE OF FUNCTIONALITY 	<ul style="list-style-type: none"> - FUNCTIONS AS EXTENSION UNIT - MAKES IT EASIER, SAFER AND MORE CONVENIENT TO POSITION THE TOOL CORRECTLY INSIDE THE SPRING - PREVENTS OVERLOAD - IMPROVES SAFETY 	<ul style="list-style-type: none"> - MAX LOAD 1500KG - TWO SETS OF JAWS: 2 SMALL ANGLED JAWS Ø 90-120MM AND 2 LARGE ANGLED JAWS Ø 120-140MM FOR MERCEDES AND MANY OTHER CARS WITH WISHBONE/MULTILINK SUSPENSION - USE AIR WRENCH - MAX DISTANCE: 167 MM - MIN DISTANCE: 70 MM - WEIGHT BODY: 1.65 KG - WEIGHT INCLUDE JAWS: 2.5KG 	<p>LARGE ANGLED AND LARGE FLAT JAWS ARE AVAILABLE ON REQUEST</p>

48002

THE FLOOR JACKS IN THIS CATEGORY ARE CERTIFIED TO THE HIGHEST LEVEL OF USEFUL LIFE (PROFESSIONAL USE AND NOT OCCASIONAL USE) TO ENSURE MAXIMUM VALUE FROM YOUR INVESTMENT. ALL ARE MADE OF THE BEST MATERIALS AVAILABLE AND CONSTRUCTED IN ACCORDANCE WITH THE LATEST AND MOST ADVANCED TECHNIQUES. REACHING NEW HEIGHTS IN PROFESSIONAL SHOP EQUIPMENT.



08

FOOT PEDAL



ERGONOMIC HANDLE



RUBBER PROTECTION PAD



3 YEARS WARRANTY



TANDEM WHEELS

LIGHTWEIGHT ULTRA LOW PROFILE JACK WITH A MINIMUM HEIGHT OF 85MM, FAST REACH FOOT PEDAL, RUBBER SADDLE, PU TANDEM WHEELS, HOLD TO RUN CONTROL AND ERGONOMIC HANDLE. POLYURETHANE TANDEM ROLLERS REDUCE NOISE AND FLOOR DAMAGE. THE TANDEM SYSTEM GUARANTEES A COMFORTABLE RIDE ON A BUMPY SURFACE.

GARAGE JACK WITH DOUBLE WHEELS, 2 TON

- CAPACITY 2 TON
- WEIGHT 37,2KG
- RUBBER PROTECTION PAD
- ERGONOMIC HANDLE
- PU TANDEM WHEELS
- MIN. HEIGHT 85MM
- MAX. HEIGHT 490MM

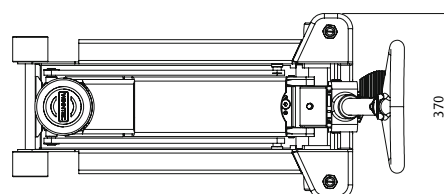

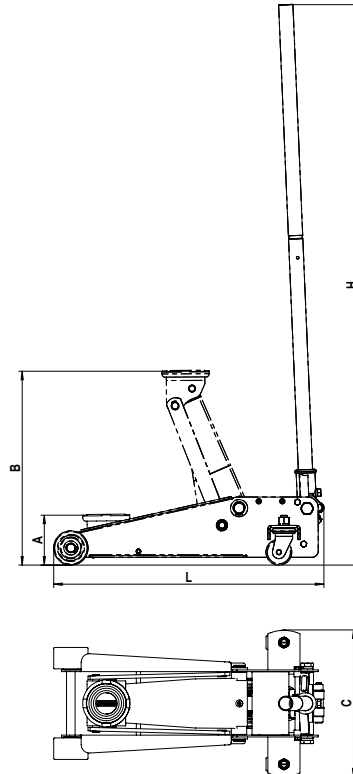

GARAGE JACK, 2 TON

LIGHT WEIGHT LOW PROFILE JACK WITH A MINIMUM HEIGHT OF JUST 115MM, RUBBER SADDLE, NYLON WHEELS AND A PUMP HANDLE THAT CAN EASILY BE (DIS)ASSEMBLED MAKING THIS JACK IDEAL FOR A LARGE VARIETY OF (MOBILE) SERVICE JOBS.

- CAPACITY 2 TON
- WEIGHT 30KG
- RUBBER SADDLE
- LOW PROFILE JACK

- NYLON WHEELS
- MIN. HEIGHT 115MM
- MAX. HEIGHT 450MM

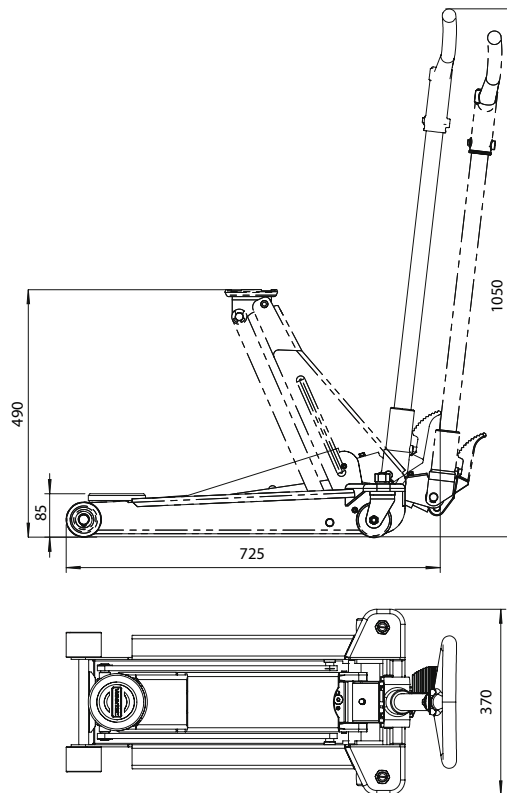

ART. NO. 4800206
RUBBER PROTECTION PAD

GARAGE JACK, 2 TON

LIGHTWEIGHT ULTRA LOW PROFILE JACK WITH A MINIMUM HEIGHT OF 85MM, FAST REACH FOOT PEDAL, RUBBER SADDLE, NYLON WHEELS, HOLD TO RUN CONTROL AND ERGONOMIC HANDLE. COMPACT DESIGN IDEAL FOR WORKING IN TIGHT SPACES AND TRANSPORTATION IN SERVICE VEHICLES.

- CAPACITY 2 TON
- WEIGHT 36.5KG
- RUBBER PROTECTION PAD
- ERGONOMIC HANDLE

- NYLON WHEELS
- MIN. HEIGHT 85MM
- MAX. HEIGHT 490MM

48003

CAP. 3000KG ⓘ

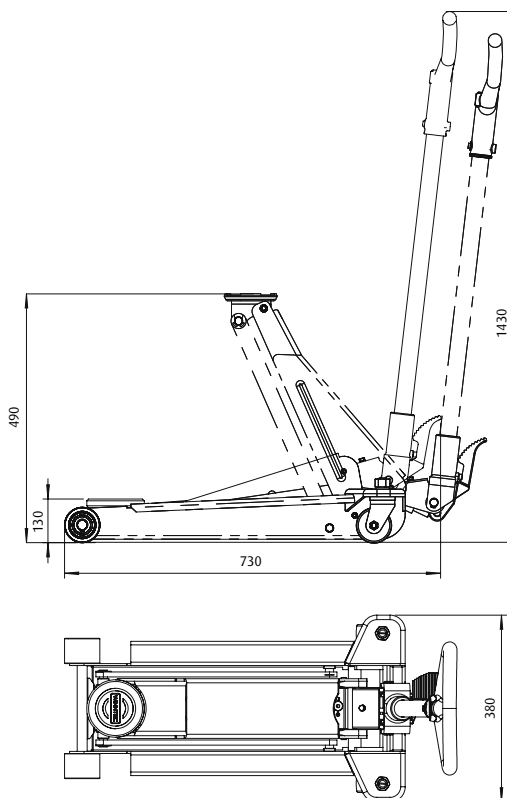

ART. NO. 4800207
RUBBER PROTECTION PAD

GARAGE JACK, 3 TON

THIS JACK IS EQUIPPED WITH SONICS UNIQUE TURBO LIFTER SYSTEM, RUBBER SADDLE AND HANDLE BUMPER. THE PROFESSIONAL UNIVERSAL JOINT RELEASE VALVE MAKES IT POSSIBLE TO LOWER THE JACK WITH LOAD VERY PRECISELY AND FREE OF ANY RISKS. THE HEAT-TREATED CHROMED PUMP PISTONS (PROTECTED WITH JACKET TO PREVENT FROM INTRUSION OF DIRT) ARE PLACED AT A 45° ANGLE SO A COMPLETE PUMPING STROKE WILL ALWAYS BE UTILIZED. ALSO MAIN RAM HAS A CHROME PLATING WHICH ENSURES MAXIMUM DURABILITY.

- CAPACITY 3 TON
- WEIGHT 41KG
- RUBBER PROTECTION PAD
- HANDLE BUMPER
- NYLON WHEELS
- MIN. HEIGHT 130MM
- MAX. HEIGHT 490MM

48004

CAP. 1350KG ⓘ

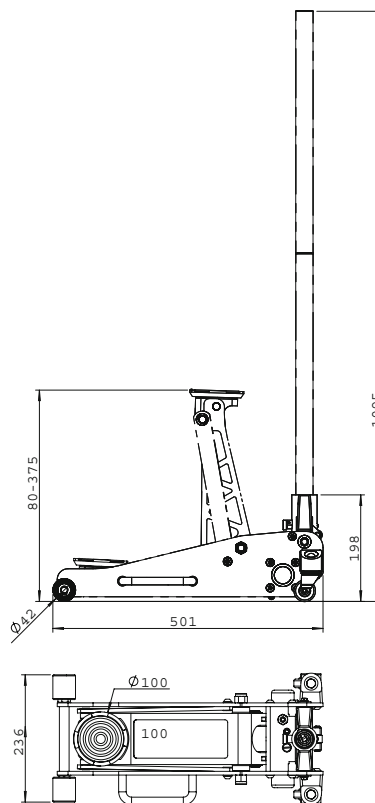

ART. NO. 4800203
INCL. EXTRA RUBBER PAD
95MM



ART. NO. 4800205
RUBBER PROTECTION PAD

ALUMINIUM JACK, 1,35 TON

WITH A 1,35T LIFT CAPACITY AND A 80MM MINIMUM LIFT HEIGHT IT ENSURES EASY ACCESS UNDER LOW-PROFILE VEHICLES. THE BALL BEARING-MOUNTED REAR SWIVEL CASTER WHEELS AND WIDE TRACK FRONT WHEELS PROVIDE EASY MANEUVERABILITY AND JACK STABILITY UNDER LOAD. A NEWLY DESIGNED SADDLE PAD PROTECTS THE VEHICLES FRAME AND COMPONENTS. THICK FRAME SIDE PLATES AND A REINFORCED LIFT ARM RESULT IN ADDED STRENGTH. A BYPASS AND OVERLOAD VALVE PREVENT FROM OVER-EXTENSION OF HYDRAULIC RAM AND JACK USE BEYOND RATED CAPACITY. THE 2-PCS HANDLE WITH QUICK LOCK OFFERS EASY STORAGE. HEAVY DUTY NYLON WHEELS KEEP THE JACK'S GENERAL WEIGHT BELOW 10KG.

- CAPACITY 1,35 TON
- WEIGHT 10KG
- 2 PCS HANDLE BAR
- 1 OVERSIZED HANDLE
- RUBBER PROTECTION PAD
- MIN. HEIGHT 80MM
- MAX. HEIGHT 375MM
- BYPASS AND OVERLOAD VALVE PREVENT FROM OVER-EXTENSION



JACK STANDS, 3 TON

- MAXIMUM CAPACITY 3 TON
- MINIMUM HEIGHT 305MM
- MAXIMUM HEIGHT 448MM

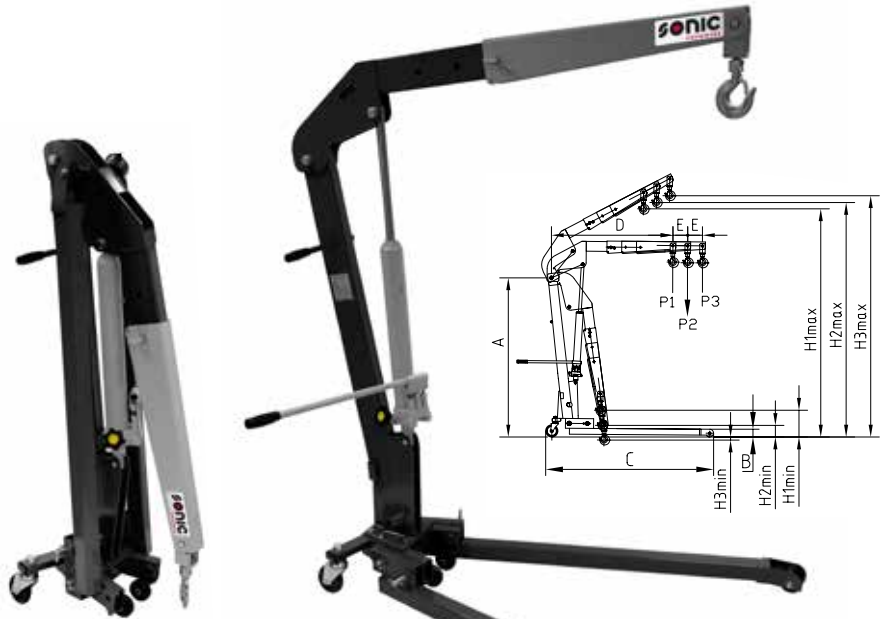

SCISSOR JACK 1 TON

- MAXIMUM CAPACITY 1 TON
- MINIMUM HEIGHT 90MM
- MAXIMUM HEIGHT 330MM

ENGINE CRANE FOLDABLE, 1 TON

CONSTRUCTED FROM HEAVY GAUGE, WELDED SQUARE TUBULAR STEEL. THE 2 SPEED HYDRAULIC PUMP WITH CHROMED RAM ROTATES UP TO 135 DEGREES ENSURING THE OPTIMAL WORKING POSITION. FINE ADJUSTMENT LOWERING HANDLE WITH DEAD MAN'S CONTROL PREVENTS FROM RAPID UNCONTROLLED LOWERING OF LOAD. NYLON WHEELS AVOID FLOOR DAMAGE. THE ARM HAS 3 PRE-SET POSITIONS FOR LIFTING. EASY TO MANEUVER IN OPEN OR CLOSED POSITION DUE TO UNIQUE SUPPORTING WHEELS AT THE FRONT OF THE BASE PLATE.

- STATIC LIFTING CAPACITY: 1000KG
- WEIGHT: 71KG
- MEASUREMENTS FOLDED: L1499MM X B90MM X H1405MM

POSITION	CAPACITY	MIN. HEIGHT	MAX. HEIGHT
1	1000KG	334MM	2120MM
2	750KG	214MM	2210MM
3	500KG	94MM	2300MM

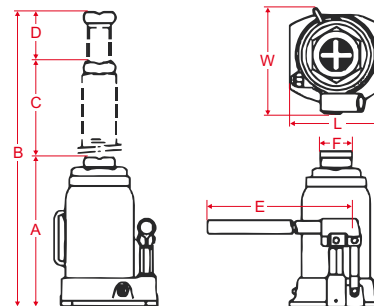

BOTTLE JACK

- ADJUSTABLE SCREW ROD-TO ADJUST TO SUITABLE OPERATING HEIGHT
- PISTON ROD OIL CYLINDER ARE RISING AND LOWERING IN LINEAR MOVEMENT
- TOP WITH CROSS GROOVES (LOADING CONTACT SEGMENT)
- PRESSING HANDLE TO PRESS UP AND DOWN TO MAKE THE PISTON ROD RISE
- THE RELEASE VALVE IS TO CONTROL RAISING OR LOWERING FUNCTION

ART. NO.	MIN-MAX HEIGHT	CAP. (TON)	A	B	C	D	E	F	L	W	N.W. (KG)	PCS CARTON	CARTON G.W.(KG)	CBM/CTN	PIECES/20'CY
4800102	158 - 308MM	2	158	308	90	60	285	20	93	88	2.30	10	25.0	0.025	6250
4800104	180 - 350MM	4	180	350	110	60	340	25	104	108	3.20	8	28.0	0.025	4460
4800106	197 - 382MM	6	197	382	125	60	340	30	113	116	4.40	6	28.0	0.023	3500
4800108	205 - 390MM	8	205	390	125	60	340	33	120	115	5.40	4	23.0	0.018	2430
4800112	215 - 400MM	12	215	400	125	60	340	40	133	137	7.20	2	15.5	0.012	1800
4800120	244 - 449MM	20	244	449	145	60	420	45	155	165	11.00	2	23.0	0.018	1400

Power lights

POWER
LIGHTS



08

SONIC WILL INTRODUCE THE NEXT GENERATION OF THE POPULAR BESTSELLERS. THIS NEW LIGHT IS EXTREMELY POWERFUL, RECHARGEABLE AND CAN BE USED AS A FLASHLIGHT AND IS USING A HIGH PERFORMANCE LED TECHNOLOGY PROVIDING UP TO TWO TIMES MORE LIGHT OUTPUT. ALL THESE CAN BE CHARGED BY USB. WITH THE THREE STRONG BUILT-IN MAGNETIC HOLDERS AND THE TWO RETRACTABLE SUSPENSION HOOKS, CONVENIENCE IS APPROVED. THE LIGHT IS MULTI FLEXIBLE AND TILTS UP TO 180 DEGREES.



Compact



Swivel head



Hook



Spotlight



Ergonomic



Sensor modus

**POWER
LIGHTS**

4820515

 4820516





MULTIFUNCTIONAL INSPECTION WORKLIGHT

GENERAL INFORMATION

EXTREMELY POWERFUL LED WORKLIGHT AND FLASHLIGHT IN ONE

- WORKLIGHT WITH 3 MAGNETS
- LAMP HEAD TILTS UP TO 180 DEGREES
- TWO ADJUSTABLE AND RETRACTABLE SUSPENSION HOOKS
- 1200 MAH LI-ION RECHARGEABLE HIGH CAPACITY BATTERY
- 7X SMD LED (MAIN LIGHT)
- HIGH POWER LED SPOTLIGHT
- WORKLIGHT: 120 LUMEN
- SPOTLIGHT: 50 LUMEN
- LIGHT INTENSITY WORK LIGHT: 250 LUX AT 0.5M
- LIGHT INTENSITY SPOTLIGHT: 500 LUX AT 0.5M
- OPERATING TIME WORK LIGHT: 4 HOURS
- OPERATING TIME SPOTLIGHT: 4 HOURS
- 4 HOURS CHARGING TIME
- INCLUDING 220 V CHARGER
- INCLUDING USB CHARGER
- PROTECTION IP20

MINIFORM POCKET-SIZED, ULTRA-SLIM WORK LIGHT

GENERAL INFORMATION

MINIFORM POCKET-SIZED, ULTRA-SLIM WORK LIGHT

- ULTRA SLIM POCKET-SIZED WORK LIGHT
- COB LED
- 2 STEP LIGHT OUTPUT
- 2.5 HOURS CHARGING TIME
- 1000 MAH LI-ION RECHARGEABLE HIGH CAPACITY BATTERY
- CHARGE INDICATOR COMPACTE HANDWERKLAMP
- 180° ANGLE STAND WITH MAGNET
- SWIVEL HOOK
- STEP 1: 55 LUMEN
- STEP 2: 110 LUMEN
- LIGHT INTENSITY STEP 1: 130 LUX AT 0.5M
- LIGHT INTENSITY STEP 2: 260 LUX AT 0.5M
- OPERATING TIME STEP 1: 5 HOURS
- OPERATING TIME STEP 2: 2.5 HOURS
- CHARGING TIME: 2.5 HOURS
- INCLUDING 220 V CHARGER
- INCLUDING USB CHARGER
- WEIGHT: 112G
- PROTECTION IP20

**POWER
LIGHTS**

4820517



4820518



08

MIDIFORM WORK LAMP WITH TOP FLASH LIGHT

GENERAL INFORMATION

- MULTIPURPOSE WORK LIGHT WITH TOP FLASH LIGHT
- COB LED / HIGH POWER
- 3 HOURS CHARGING TIME
- 1600 MAH LI-ION RECHARGEABLE HIGH CAPACITY BATTERY
- CHARGE INDICATOR
- 180° ANGLE STAND WITH MAGNET
- SWIVEL HOOK
- WORK LIGHT: 150 LUMEN
- SPOTLIGHT: 75 LUMEN
- LIGHT INTENSITY: 100 LUX AT 0.5M
- LIGHT INTENSITY: 340 LUX AT 0.5M
- OPERATING TIME WORKLIGHT: 3 HOURS
- OPERATING TIME SPOTLIGHT: 3 HOURS
- INCLUDING 220 V CHARGER
- INCLUDING USB CHARGER
- WEIGHT: 160G
- PROTECTION IP20

I-VIEW HEADLAMP

GENERAL INFORMATION

- LIGHTS UP YOUR ENTIRE FIELD OF VIEW
- NEW RECHARGEABLE BATTERY TECHNOLOGY
- DESIGNED FOR PROFESSIONAL WORK
- SENSOR FUNCTION
- 1600 MAH LI-ION RECHARGEABLE HIGH CAPACITY BATTERY
- 2W COB LED
- STEP 1: 80 LUMEN
- STEP 2: 160 LUMEN
- LIGHT INTENSITY STEP 1: 300 LUX AT 0.5M
- LIGHT INTENSITY STEP 2: 500 LUX AT 0.5M
- OPERATING TIME STEP 1: 6 HOURS
- OPERATING TIME STEP 2: 3 HOURS
- CHARGING TIME: 4 HOURS
- WEIGHT: 140G
- PROTECTION IP65



2X ADJUSTABLE SUSPENSION HOOKS

SPOTLIGHT 5 LEDS

3 BUILT-IN MAGNETS

PLACE ANYWHERE YOU WANT 3 STRONG BUILT-IN MAGNETS + 2 RETRACTABLE SUSPENSION HOOKS

LIGHT AND TORCH 21+5 LEDS

PLACE ANYWHERE YOU WANT 3 STRONG BUILT-IN MAGNETS + 2 RETRACTABLE SUSPENSION HOOKS

GENERAL INFORMATION

- OPERATING TIME MAIN LIGHT UP TO 4 HOURS
- CHARGING TIME 4 HOURS
- SPOT LIGHT WITH 5 HIGH BRIGHT LEDS
- 3.7V / 1200MAH LI-ON RECHARGEABLE BATTERY
- LED INTENSITY AT 50CM SPOTLIGHT 300 LUX
- IP20
- OPERATING TIME SPOT LIGHT UP TO 15 HOURS
- MAIN LIGHT WITH 21 HIGH BRIGHT LEDS
- BATTERY CHARGER 230V AC/50HZ
- LED INTENSITY AT 50CM MAIN LIGHT 800 LUX
- OPERATING TEMPERATURE -10 TO +40°C
- WEIGHT 0,30KG

NOVA COB LED LIGHT 30W

GENERAL INFORMATION

- NEW AND INNOVATIVE STRONG COB LED WORK LIGHT DESIGNED WITH THE NEWEST STATE-OF-THE-ART LED TECHNOLOGY! THE BODY IS MADE OF DIE CASTED ALUMINIUM PROTECTED BY A STRONG RUBBER FRAME. THE EXTREME DURABILITY OF THE LAMP COMBINED WITH THE LONG LIFETIME OF THE LED MAKES THE NOVA 'A LAMP FOR LIFETIME'. THE FLEXIBLE STAND MAKES IT POSSIBLE TO PLACE THE LAMP IN THE DESIRED ANGLE
- 5M CABLE (2X1.0MM²)
 - 30W COB LED
 - 3300 LUMEN
 - 500 LUX AT 50 CM



CREE LED FLASH LIGHT

GENERAL INFORMATION

- 1W LED POCKET FLASHLIGHT
- 100 LUMEN
- 50.000 HOURS LIFESPAN
- RUNTIME 2 HOURS
- BATTERY: 2XAAA (LR03) (NOT INCLUDED)

EXTREMELY POWERFUL PENCIL LIGHT 1W LED

GENERAL INFORMATION

- BRIGHTNESS LEVEL 1100 LUX
- OPERATING TIME UP TO 8 HOURS
- LIGHT BEAM UP TO 75MTR
- BATTERY 2X AAA INCLUDED
- WATERPROOF (IP54)
- DELIVERED IN A GIFT BOX

RECHARGEABLE COB WORK LIGHT 2W

GENERAL INFORMATION

- 2W COB POCKET WORKLIGHT
- 3 SMD LED TOP TORCH
- SWIVEL HOOK AND STRONG MAGNET
- 180° ANGLE STAND
- POCKET CLIP
- BATTERY 3.7 V, 1800 MAH, LITHIUM BATTERY
- WORKLIGHT: 180 LUMEN
- TOP TORCH: 60 LUMEN
- OPERATING TIME COB LED: 3 HOURS
- OPERATING TIME 3 SMD LED: 10 HOURS
- CHARGING TIME: 4-5 HOURS
- INCLUDING 220 V CHARGER
- INCLUDING USB CHARGER
- WEIGHT: 140G
- MEASUREMENTS: 130 L X 65 B X 30 D MM

4820503



4820513



4820509



MAGNETIC

SWITCH

SPOTLIGHT



STRIP LED WORK LIGHT 2W + TOP TORCH

GENERAL INFORMATION

- SWIVEL BODY AND MAGNETIC
- BATTERY 3.7V 2000MAH LITHIUM BATTERY
- 2W / 130 LUMEN
- WORK TIME: 3 HOURS FOR STRIP LED
- WORK TIME: 15 HOURS FOR 5 LED
- RECHARGE TIME: 5-6 HOURS
- IP20

INSPECTIONS WORK LIGHT 8W

GENERAL INFORMATION

- NOMINAL VOLTAGE 230 V ~ 50-60 HZ
- MAIN CABLE 5 M, 2X0.75 MM2
- ELECTRONIC BALLAST IN HANDLE
- "NOT EXPLOSION PROOF"

RECHARGEABLE COB WORK LIGHT 3W

GENERAL INFORMATION

- BATTERY 3.7V 1900MAH
- 160 LUMEN
- LITHIUM BATTERY
- WORK TIME: 3 HOURS
- RECHARGE TIME: 4-5 HOURS
- INCLUSIVE 12V CAR ADAPTOR, EXTREMELY THIN
- L 290MM, H 22MM, W 38MM

4821111



4821112



4821110



MAGNETIC ADJUSTABLE 3W COB WORKLIGHT

GENERAL INFORMATION

- SWIVEL HANGER AND MAGNET; CONVENIENT FOLDAWAY HANGING HOOK. BUILT-IN MAGNET MOUNTS LIGHT TO METAL SURFACES.
- 180° VERTICAL ADJUSTABLE BRACKET DESIGN FOR MULTIPLE-PURPOSE USE
- 3 WORKING MODE: 3W COB LED(HIGH)/3W COB LED(LOW)/1W LED/OFF
- MADE OF ABS, SURE-GRIP RUBBER FINISH
- BATTERY: 3XAA (LR06) (NOT INCLUDED)
- LIGHT OUTPUT:
- 120 LUMENS/3W COB LED HIGH
- 60 LUMENS/3W COB LED LOW
- 45 LUMENS/1W LED
- RUNTIME:
- 3.5 HOURS/3W COB LED HIGH
- 7 HOURS/3W COB LED LOW
- 7.5 HOURS/1W LED
- LIGHT EFFECTIVE RANGE:
- 8M/3W COB LED HIGH
- 6M/3W COB LED LOW
- 36M/1W LED
- IPX4 WATERPROOF AND SHOCK RESISTANT
- SIZE: 226(L)X 60(W)X47 (THK.)MM
- WEIGHT WITHOUT THE BATTERIES: 172G

COMPACT ALL-PURPOSE WORK LIGHT

GENERAL INFORMATION

- SWIVEL HANGER AND MAGNET
- MADE OF ABS, SURE-GRIP RUBBER FINISH
- BATTERY: 3XAA (LR06) (NOT INCLUDED)
- 1W COB-LED FLOOD LIGHT
- LIGHT OUTPUT: 90 LUMENS
- LIGHT EFFECTIVE RANGE: 6M
- RUNTIME: 5 HOURS
- IPX4 WATERPROOF AND SHOCK RESISTANT
- SIZE: 195(L)X 62.5(W)X 35(THK.) MM
- WEIGHT WITHOUT THE BATTERIES: 110G

RECHARGEABLE ADJUSTABLE ROTARY WORK LIGHT

GENERAL INFORMATION

- BUILT-IN MAGNET AT THE BOTTOM AND COMPACT HOOK AT THE BACK
- MADE OF ABS, SURE-GRIP RUBBER FINISH
- 180° VERTICAL ADJUSTABLE BRACKET AND 360° HORIZONTAL ROTARY DESIGN FOR MULTIPLE PURPOSE USE
- BATTERY: 3.7V 2200MAH RECHARGEABLE LI-ION BATTERY (INCLUDED)
- 2-IN-1 DESIGN FEATURES A 3W COB-LED FLOOD LIGHT AND 1W LED SPOT LIGHT
- LIGHT OUTPUT:
- 120 LUMENS / 3W COB LED FLOOD LIGHT
- 45 LUMENS / 1W LED SPOT LIGHT
- RUNTIME:
- 2.5 HOURS / 3W COB LED FLOOD LIGHT
- 6.0 HOURS / 1W LED SPOT LIGHT
- CHARGING TIME: 4-5 HOURS
- INCLUDE 100-240V AC ADAPTOR & 12V DC PLUG-IN VEHICLE CHARGER
- IPX4 WATERPROOF AND SHOCK RESISTANT
- SIZE: 260(L)X63(W)X46(H) MM
- WEIGHT: 296G



BLACK FALCON, GERMANY

Boosters



08



VOLTMETER: THE SONIC BOOSTER USES A TRADITIONAL VOLTMETER TO SHOW THE CHARGING LEVEL.

CLAMPS: THE MASSIVE CLAMPS ARE FULLY INSULATED AND ERGONOMIC WITH BIG OPENING.

FUSES: THE INTERNAL FUSE PROTECTS THE BATTERIES AGAINST SHORT-CIRCUITS AND OVERCHARGE (OVERUSE).

BUZZER: A BUZZER THAT PRODUCES A TONE WILL INFORM YOU OF AN INVERSION OF POLARITY.

THE SONIC BOOSTER RANGE OFFERS PROFESSIONAL AND RELIABLE SOLUTIONS FOR ALL USERS. IN TERMS OF POWER, OUR RANGE STARTS WHERE OTHER COMPETITORS END THEIRS. OUR LEAST POWERFUL BATTERIES DELIVER MORE POWER THAN MOST AVERAGE BATTERIES OF COMPETING PRODUCTS. THE SONIC BOOSTERS ARE PROFESSIONAL TOOLS DESIGNED FOR PROFESSIONAL AND INTENSIVE USE.

BOOSTERS

THE SONIC BOOSTER RANGE OFFERS PROFESSIONAL AND RELIABLE SOLUTIONS FOR ALL USERS. IN TERMS OF POWER, OUR RANGE STARTS WHERE OTHER COMPETITORS END THEIRS. OUR LEAST POWERFUL BATTERIES DELIVER MORE POWER THAN MOST AVERAGE BATTERIES OF COMPETING PRODUCTS. DON'T BE MISLED BY BOOSTER AND BATTERY RATINGS! WHEN IT COMES TO JUMP STARTING VEHICLES, WHAT REALLY MATTERS IS THE POWER IN CRANKING AMPS (CA), NOT IN PEAK AMPS (PA). IN ADDITION TO POWERFUL AGM BATTERIES, OUR BOOSTERS ARE ALL EQUIPPED WITH HIGH-QUALITY COMPONENTS WHICH ARE ALSO VERY IMPORTANT: DOUBLE-INSULATED STARTING CABLES, FULLY INSULATED CLAMPS WITH CURVED AND BRONZE JAWS, RESISTANT ANDERSON CONNECTORS, ETC. THE SONIC BOOSTERS ARE PROFESSIONAL TOOLS DESIGNED FOR PROFESSIONAL AND INTENSIVE USE.



VOLTMETER:

THE SONIC BOOSTER USES A TRADITIONAL VOLTMETER WITH A NEEDLE WHEN OTHER COMPETING PRODUCTS USE LED LIGHTS TO SHOW THE CHARGING LEVEL. THE VOLTMETER INDICATES THE PRECISE CHARGING LEVEL AND CAN BE USED TO TEST THE PROPER FUNCTIONING OF THE ALTERNATOR OF THE VEHICLE: THE BATTERY OF A BOOSTER MUST REACH 13V WHEN IT'S RECHARGED AND WHEN IT'S CONNECTED TO THE CAR-BATTERY. THE ENGINE MUST REACH 14,4V BECAUSE THAT'S THE POWER YOUR CAR ALTERNATOR MUST PRODUCE.

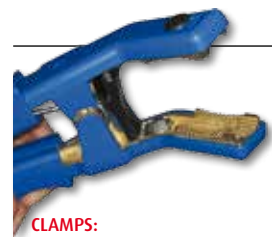

CLAMPS:

THE MASSIVE CLAMPS OF THE SONIC BOOSTER ARE FULLY INSULATED AND ERGONOMIC WITH BIG OPENING AND A BRAIDED COPPER STRAP IN ORDER TO SPREAD CURRENT THROUGH BOTH JAWS. CLAMPS FROM OTHER BOOSTERS ARE LESS USER-FRIENDLY AND DON'T DELIVER FULL CURRENT THROUGH BOTH JAWS. THEY ARE ALSO LESS ROBUST.



FUSES:

THE INTERNAL FUSE PROTECTS THE BATTERIES AGAINST SHORT-CIRCUITS AND OVERCHARGE (OVERUSE).

CABLES:

SONIC STARTING CABLES ARE DOUBLE INSULATED, EXTRA-LONG, EXTREMELY FLEXIBLE AND OF VERY HIGH CONDUCTIBILITY. CABLES OF OTHER BOOSTERS ARE TINY AND THAT'S WHY THEY MAKE KNOTS INSIDE AND BREAK.

CASE:

THE SINGLE-PIECE MOULDED CASE IN POLYETHYLENE OF 5MM, UNBREAKABLE AND WITH A LIFETIME WARRANTY ASSURES EXCELLENT RESISTANCE TO SHOCKS AND INTENSIVE USES. CASES OF OTHER BOOSTERS ARE SLIM AND MADE OUT OF 2 PARTS. SO IT'S FRAGILE AND MORE DIFFICULT TO HANDLE WHEN YOU HAVE TO REPAIR.

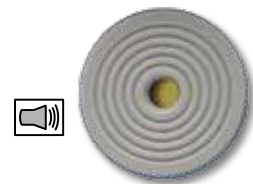

BUZZER:

A BUZZER THAT PRODUCES A TONE WILL INFORM YOU OF AN INVERSION OF POLARITY. IN OPTION FOR THE 12V SONIC MODELS.



SONIC
BOOSTER

start engine use sonic booster



- READ MANUAL FIRST
- CHARGE THE SONIC BOOSTER COMPLETELY BEFORE USE
- TO ENSURE LONG LIFE AND OPTIMIZE THE USE OF THE SONIC BOOSTER BATTERY, YOU MUST PUT THE SONIC BOOSTER ON CONTINUOUS CHARGE AFTER EACH USE USING THE AUTOMATIC PROVIDED CHARGER
- WHEN NOT USING THE SONIC BOOSTER FOR LONG PERIOD OF TIME, RECHARGE THE UNIT (USING THE ORIGINAL AUTOMATIC ELECTRIC 230V AC CHARGER) EVERY 3 MONTHS FOR AT LEAST 48HRS
- WHEN USING THE SONIC BOOSTER TO START AN ENGINE, DO NOT CRANCK FOR MORE THAN 8-10 SECONDS, AND WAIT FOR A FUTHER 3 MINUTES BEFORE A SECOND ATTEMPT
- NEVER COMPLETELY DISCHARGE THE SONIC BOOSTER BATTERY
- NEVER RECHARGE THE SONIC BOOSTER USING A 24V RECHARGING (CIGARETTE LIGHTER) PLUG ON BOARD OF A VEHICLE

THE MOST POWERFUL BOOSTERS ON THE MARKET

48132



BOOSTER PORTABLE MINI 12V/440CA

- VOLTAGE 12V
- CRANKING AMPS 440A
- PEAK AMPS 1600A
- CABLE LENGTH 60CM
- CABLE SIZE 25MM²
- ADAPTOR AC/DC 1.3A
- FUSE ON BATTERY 300A
- WEIGHT 6,5KG
- DIMENSIONS CM (LXBXH) 36 X 13 X 24 CM



48108



12V/1200CA

- GASOLINE OR DIESEL, UTILITY, 4X4, SECOND-HAND AND AGRICULTURAL SERVICE TO START DIESEL ENGINES UP TO
- 350HP AS BOOSTER
 - 250HP AS SUBSTITUTE BATTERY

48106



MICRO 12V/700CA

- GASOLINE OR DIESEL, UTILITY TO START DIESEL ENGINES UP TO
- 175HP AS BOOSTER
 - 125HP AS SUBSTITUTE BATTERY
- GASOLINE ENGINES:
CAPABLE TO START 250HP WITHOUT BATTERY

48107



MICRO 12V/800CA

- GASOLINE OR DIESEL, UTILITY TO START DIESEL ENGINES UP TO
- 250HP AS BOOSTER
 - 150HP AS SUBSTITUTE BATTERY
- GASOLINE ENGINES:
CAPABLE TO START A HUMMER H2/350HP WITHOUT BATTERY

48110



12/24V-3200/1600CA

- GASOLINE OR DIESEL, LIGHT TRUCK, AGRICULTURAL SERVICE, HEAVY TRUCK, BUS, TANK, PLANE, BOAT, ETC. FLEXIBLE 12V OR 24V FOR EXTREME USE, 25% MORE POWER THAN THE 12/24V-2400/1200CA UNIT PERFECT FOR STARTING ENGINES UP TO 1500HP WHICH HAVE BEEN STATIONARY FOR A LONG TIME, IN EXTREME TEMPERATURE CONDITIONS FROM -30° TO +60°C, WITHOUT BATTERIES

48111



12/24V-1600/800CA

- GASOLINE OR DIESEL, UTILITY, 4X4, SECOND-HAND AND AGRICULTURAL SERVICE, HEAVY TRUCK TO START DIESEL ENGINES IN 24V UP TO
- 500HP AS BOOSTER
 - 250HP AS SUBSTITUTE BATTERY

48109



12/24V-2400/1200CA

- GASOLINE OR DIESEL, LIGHT TRUCK, AGRICULTURAL SERVICE, HEAVY TRUCK, BUS, TANK, PLANE, BOAT, ETC. PERFECT FOR STARTING ENGINES UP TO 1500HP WHICH HAVE BEEN STATIONARY FOR A LONG TIME, IN EXTREME TEMPERATURE CONDITIONS FROM -30° TO +60°C, WITHOUT BATTERIES PRACTICAL EXAMPLE: CAPABLE TO START A 1500HP 38 LITRES, MERCEDES LEOPARD TANK WITHOUT BATTERIES

FOR WHOM PERFORMANCE REALLY COUNTS

POWER:

OUTCOME FROM THE AERO SPACE TECHNOLOGY, THE BATTERIES IN THE SONIC BOOSTER (AGM/MF, PURE LEAD, MADE IN USA) HAVE AN EXTRAORDINARY ENERGY STORAGE AND DELIVERY AT VERY HIGH CURRENTS.

ELECTRONIC PROTECTION:

THE SONIC BOOSTER IS NO DANGER FOR THE ELECTRONIC EQUIPMENT OF THE VEHICLES. THESE JUMP STARTERS HAVE DONE MILLIONS OF STARTINGS WITHOUT ANY DAMAGE (CERTIFICATE OF AXA INSURANCE POLICY - NO FILE HAS BEEN OPENED IN MORE THAN 20 YEARS).

LIABILITY:

ALL THE COMPONENTS OF THE SONIC BOOSTER HAVE BEEN SELECTED WORLDWIDE FOR THEIR VERY HIGH QUALITY FOR AN INTENSIVE USE DEDICATED FOR PROFESSIONALS:

THE MOULDED SINGLE-PIECE POLYETHYLENE BODY OF 5 MM, UNBREAKABLE (LIFE TIME WARRANTY), ASSURES EXCELLENT RESISTANCE TO THE SHOCKS AND EVERYDAY USES. DOES NOT TAKE MUCH SPACE IN A RECOVERY SERVICE VEHICLE AND ITS ERGONOMIC SHAPE FACILITATES ITS USE AND STORAGE.

THE RADAFLEX® STARTING CABLES (DOUBLE ISOLATION) EXTRA-LONG, ARE EXTREMELY FLEXIBLE AND OF VERY HIGH CONDUCTIBILITY. THEY ALLOW THE USER TO LEAVE THE BOOSTER ON THE GROUND WHILE STARTING THE VEHICLE.

THE ELECTRONIC AUTOMATIC CHARGER WITH CONTINUOUS CURRENT, MANAGES AND MAINTAINS THE BATTERY IN PERFECT CONDITION IN ORDER TO GIVE FULL POWER AT START. THE RECHARGING CORD THROUGH CIGARETTE-LIGHTER (DC/DC) ALLOWS A QUICK RECHARGE ON BOARD OF A 12V VEHICLE.

WARRANTY: ALL USER BENEFITS FROM A ONE-YEAR WARRANTY ON COMPONENTS AND WORKMANSHIP



MODEL	BOOSTER MINI 12V/440CA	MICRO 12V/700CA	MICRO 12V/800CA	SONIC 12V/1200CA	SONIC 12/24V 1600/800CA	SONIC 12/24V 2400/1200CA	SONIC 12/24V 3200/1600CA
SONIC ITEM	48132	48106	48107	48108	48111	48109	48110
VOLTAGE (DC VOLTS)	12V	12V	12V	12V	12/24V	12/24V	12/24V
CRANKING AMPS	440 A	700 A	800 A	1200 A	1600/800 A	2400/1200 A	3200/1600 A
PEAK AMPS	1600 A	1860 A	2370 A	3100 A	4740/2370 A	6200/3100 A	7750/3875 A
NUMBER OF BATTERIES	1	1	1	1	2	2	2
CABLE LENGTH	60 CM	1,30 M	1,30 M	1,50 M	1,35 M	1,35 M	1,95 M
RADAFLEX WELDING CABLE SIZE	25 MM ²	25 MM ²	25 MM ²	35 MM ²	50 MM ²	50 MM ²	70 MM ²
TYPE OF CLAMPS	F600	F600	650 A	850 A	850 A	850 A	850 A
AUTO. ELECTR. CHARGER AC/DC	1,3 A	1,3 A	2A	2A	4A	4A	7 A
POWER ADAPTER CORD DC/12V	YES	YES	YES	YES	UPON REQUEST	UPON REQUEST	UPON REQUEST
12V OUTPUT	16A	16A	16A	16A	16A	16A	16A
REVERSE POLARITY SYSTEM	OPTION	OPTION	OPTION	OPTION	YES	YES	YES
FUSED PROTECTION	YES	YES	YES	YES	YES	YES	YES
WEIGHT	6,5 KG	9,5 KG	9,5 KG	14,5 KG	21,5 KG	24,8 KG	55 KG
SHIPPING WEIGHT	8,5 KG	11,5 KG	11,5 KG	16,5 KG	23 KG	27 KG	59,5 KG
DIMENSIONS (MM)	360X130X240MM	375X110X320MM	375X110X320MM	450X247X390MM	530X160X480MM	530X160X480MM	470X340X970MM



48112...



ART. NO.	DESCRIPTION
4811205	TRIPLE WRAP CABLE SONIC MICRO (1,9M INSTEAD OF 1,3M)
4811206	TRIPLE WRAP CABLE SONIC PORTABLE 12V (2,4M INSTEAD OF 1,5M)
4811207	DOUBLE WRAP CABLE SONIC PORTABLE 12/24 & 24V (2,3M INSTEAD OF 1,35M)

4811208



ART. NO.	DESCRIPTION
4811208	DOUBLE WRAP CABLE SONIC MOBILE (3,7M INSTEAD OF 1,95M)

48112...



ART. NO.	DESCRIPTION
4811209	BATTERY 12V - 700A (180X75X168MM) FOR SONIC MICRO 12V/700CA
4811210	BATTERY 12V - 800A (180X75X168MM) FOR SONIC MICRO 12V/800CA & SONIC 12/24V - 1600/800CA

48112...



ART. NO.	DESCRIPTION
4811211	BATTERY 12V - 1200A (250X95X 158MM) FOR SONIC 12V/1200CA, 12/24 - 2400/1200CA & 24V/1200CA
4811212	BATTERY CYCLONE 12V - 1600A (255X170X 195MM) FOR SONIC MOBILE 12V/1600CA, 12V/3200CA, 12/24V - 3200/1600CA

4811213



ART. NO.	DESCRIPTION
4811213	INTERNAL ARMoured FUSE 300A TO PROTECT THE BATTERY FOR ALL SONIC BOOSTER BATTERIES 700A - 800A - 1000A

4811214



ART. NO.	DESCRIPTION
4811214	INTERNAL ARMoured FUSE 500A TO PROTECT THE BATTERY FOR ALL SONIC BOOSTER BATTERY'S 1200A - 1600A

4811215



ART. NO.	DESCRIPTION
4811215	EXTERNAL FUSE 16A FOR ALL SONIC BOOSTERS

4811216



ART. NO.	DESCRIPTION
4811216	EXTERNAL AUTOMATIC CHARGER FOR BOOSTER 12V UNITS: 12V/700CA.

4811217



ART. NO.	DESCRIPTION
4811217	EXTERNAL AUTOMATIC CHARGER FOR SONIC BOOSTER 12/800CA AND 12V/1200CA

4811218



ART. NO.	DESCRIPTION
4811218	EXTERNAL AUTOMATIC CHARGER FOR SONIC BOOSTERS 12/24V-1600/800CA AND 2400/1200CA

4811219



ART. NO.	DESCRIPTION
4811219	BATTERY CHARGER FOR SONIC BOOSTER 12/24V 3200-1600CA 7A

4811220



ART. NO.	DESCRIPTION
4811220	MALE TO MALE CORD DC/DC FOR ALL SONIC BOOSTER 12V WITH 2 MALE CIGARETTE LIGHTER PLUGS TO CHARGE THE BOOSTER ON BOARD OF A VEHICLE (ENGINE RUNNING)

4811221



ART. NO.	DESCRIPTION
4811221	MALE TO MALE CORD DC/DC FOR ALL SONIC BOOSTER 12/24V WITH 4 MALE POLES PLUG & CIGARETTE LIGHTER PLUG TO CHARGE THE BOOSTER ON BOARD OF A VEHICLE (ENGINE RUNNING)

4811262



ART. NO.	DESCRIPTION
4811262	MALE TO MALE CORD WITH OBDII PLUG

48112...



ART. NO.	DESCRIPTION
4811222	FEMALE CIGARETTE LIGHTER PLUG (FOR 12V)
4811223	MALE CIGARETTE LIGHTER PLUG (FOR 12V)

48112...



ART. NO.	DESCRIPTION
4811224	FEMALE CHARGING PLUG 4 POLES WITHOUT WIRES FOR PORTABLE SONIC BOOSTER 12/24V
4811225	FEMALE CHARGING PLUG 4 POLES WITH WIRES FOR PORTABLE SONIC BOOSTER 12/24V

48112...



ART. NO.	DESCRIPTION
4811226	FEMALE CHARGING PLUG 4 POLES WITHOUT WIRES FOR MOBILE SONIC BOOSTERS 12/24V
4811227	FEMALE CHARGING PLUG 4 POLES WITH WIRES FOR MOBILE SONIC BOOSTERS 12/24V

4811228



ART. NO.	DESCRIPTION
4811228	MALE CHARGING JACK 4 POLES FOR ALL SONIC BOOSTERS 12/24V

48112...



ART. NO.	DESCRIPTION
4811229	FEMALE CHARGING PLUG 2 POLES WITHOUT WIRES FOR ALL SONIC BOOSTERS 24V
4811230	MALE CHARGING JACK 2 POLES FOR ALL SONIC BOOSTERS 24V

48112...



ART. NO.	DESCRIPTION
4811231	CLAMP RED F600 FOR SONIC MICRO 12V/700A
4811232	CLAMP BLUE F600 FOR SONIC MICRO 12V/700A

48112...



ART. NO.	DESCRIPTION
4811233	CLAMP RED 650A, BRONZE, FULLY INSULATED + COPPER TRESS
4811234	CLAMP BLUE 650A, BRONZE, FULLY INSULATED + COPPER TRESS
4811235	CABLE (25MM ²) + CLAMP RED 650A FOR SONIC MICRO 12V/800A
4811236	CABLE (25MM ²) + CLAMP BLUE 650A FOR SONIC MICRO 12V/800A

48112...



ART. NO.	DESCRIPTION
4811237	CABLE (50MM ²) + CLAMP RED 850A FOR SONIC 12/24V - 2400/1200CA
4811238	CABLE (50MM ²) + CLAMP BLUE 850A FOR SONIC 12/24V - 2400/1200CA
4811239	CABLE (35MM ²) + CLAMP RED 850A FOR SONIC 12V & 12/24V - 1600/800CA
4811240	CABLE (35MM ²) + CLAMP BLUE 850A FOR SONIC 12V & 12/24V - 1600/800CA

4811241



ART. NO.	DESCRIPTION
4811241	VOLTMETER 8 TO 16 VOLT FOR ALL SONIC BOOSTERS 12V & 12/24V

4811242



ART. NO.	DESCRIPTION
4811242	PUSH BUTTON FOR ALL SONIC BOOSTERS

4811243



ART. NO.	DESCRIPTION
4811243	BUZZER FOR ALL SONIC BOOSTERS WITH REVERSE POLARITY SIGNAL

4811244



ART. NO.	DESCRIPTION
4811244	S. CONNECTOR YELLOW (SB175)

4811245



ART. NO.	DESCRIPTION
4811245	HANDLE FOR S. CONNECTOR

PROPULSTATION®

THE PROPULSTATION® IS A REAL REVOLUTION IN THE WORLD OF JUMP STARTERS. DEVELOPED FOR ALL PROFESSIONALS, IT MAKES THE EMERGENCY START OF ALL VEHICLES EVEN EASIER AND MORE EFFICIENT! THE UNIQUE DOCKING STATION OF THE PROPULSTATION® ALLOWS AN AUTOMATIC AND OPTIMAL RECHARGE OF THE BOOSTER IN RECOVERY VEHICLES BUT ALSO IN GARAGES AND WORKSHOPS.



UNIQUE ON THE MARKET CLAMPS:
THE MASSIVE CLAMPS OF THE SONIC BOOSTER ARE FULLY INSULATED AND ERGONOMIC WITH BIG OPENING AND A BRAIDED COPPER STRAP IN ORDER TO SPREAD CURRENT THROUGH BOTH JAWS. CLAMPS FROM OTHER BOOSTERS ARE LESS USER-FRIENDLY AND DON'T DELIVER FULL CURRENT THROUGH BOTH JAWS. THEY ARE ALSO LESS ROBUST.



VOLTAGE DETECTION SYSTEM AND CORRECT CONNECTION SIGNAL
A LED SYSTEM INDICATES THE VOLTAGE TO SELECT ON THE BOOSTER. IT REDUCES THE RISK OF MISUSE WHILE USING A 12/24V BOOSTER. IN THE CASE OF MISUSE ANY BUILD UP OF GAS WILL BE EVACUATED. THE LEDS ALSO INDICATE IF THE BOOSTER IS CORRECTLY CONNECTED TO THE STATION. IF IT IS THE CASE, THE LED CORRESPONDING TO THE VOLTAGE OF THE CHARGING CIRCUIT IS LIT ON.



THE FUSE
THE FUSE IS DIRECTLY ACCESSIBLE FROM THE OUTSIDE OF THE BOOSTER. A SPARE FUSE IS AVAILABLE ON THE SIDE OF HOUSING. A BLUE LED INDICATES THE CORRECT FUNCTIONING OF THE FUSE. IF IT DOES NOT LIGHT UP WHEN PUSHING ON THE RED BUTTON, THE FUSE IS BLOWN.



THE CONTACTOR
IT REVOLUTIONIZES AND MAKES THE STORING OF THE BOOSTER IN ITS STATION EASIER. THANKS TO THE POWERFUL MAGNETS, THE BOOSTER IS GUIDED AT ITS PLACE AVOIDING ANY RISK OF BAD CONNECTION. THE CONTACTOR ENSURES AN OPTIMAL RECHARGE OF THE BOOSTER AND AVOIDS ANY MOVEMENT WHILE STORED IN THE VEHICLE.



THE BATTERY

THIS IS THE HEART OF THE DEVICE. THEREFORE, CETEOR BATTERY HAS BEEN DESIGNED WITH THE MAIN FOCUS ON DELIVERING A MAXIMUM POWER AT START. THE BATTERY HAS EXCEPTIONALLY HIGH CAPACITY TO ACCUMULATE AND DISPERSE HIGH-AMPERAGE ENERGY. IT USES PURE LEAD PLATES AND IS AN AGM (ABSORBED GLASS MAT) TYPE BATTERY, OUTCOME OF AEROSPACE TECHNOLOGY AND OFFERS FAR SUPERIOR PERFORMANCE AND DURABILITY. WATERPROOF AND DRY, IT CAN BE STORED IN ANY POSITION IN PERFECT SAFETY.



THE HOUSING
ROBUST SHELL CASE DESIGN 5 MM SHATTERPROOF POLYETHYLENE ENSURES A HIGH LEVEL OF SHOCK AND DAILY USE RESISTANCE. WITH A LIFETIME GUARANTEE AND MODERN ESTHETICS THAT WILL ALWAYS REMAIN STYLISH AND DISCRETE THANKS TO ITS SOBER COLOR.



THE CABLES
LONG AND FLEXIBLE WITH A DOUBLE INSULATION, THEY HAVE A CROSS-SECTION CAPABLE OF DELIVERING THE BATTERIES FULL POWER. THEY OFFER A PERFECT RESISTANCE TO EXTREME CONDITIONS. (-30 °C TO 60 °C)



THE CLAMPS
THE PROPULSTATION® HAS ROBUST, WIDE-OPENING CLAMPS WHICH ARE FULLY INSULATED AND HAVE A COPPER TRACE CARRYING THE CURRENT TO BOTH OF THE BRONZE JAWS AND PROTECTING THE POWERFUL SPRING AGAINST OVER-HEATING.

PROPULSTATION® , WHEN IT'S STORED IT'S CHARGED!



PROPULSTATION® MOBILE THE POWER THAT ROLLS!

LARGE WHEELS

PROVIDE EASY MOBILITY ON THE MOST DIFFICULT TERRAIN.

ERGONOMIC HANDLES

DESIGNED TO FACILITATE THE MOVEMENT OF THE BOOSTER IN INCLINED AND VERTICAL POSITIONS, BY PULLING OR PUSHING IT.

A THIRD WHEEL MULTIDIRECTIONAL

EQUIPPED WITH A BRAKE ENSURES MANOEUVRABILITY AND IMMOBILIZATION OF THE BOOSTER ON AN INCLINED SURFACE.

5 ASSETS

1 ALWAYS IN THE RIGHT PLACE

IN THE WORKSHOP, THE BOOSTER HAS ITS PLACE AND ANY USER KNOWS WHERE TO FIND AND STORE IT. IN THE VEHICLE, IT IS PERFECTLY SET IN THE STATION.

2 ALWAYS CHARGED AT 100%

STORED IN ITS STATION, THE BOOSTER IS AUTOMATICALLY AND OPTIMALLY CHARGED BETWEEN TWO STARTS.

3 100% SUCCESSFUL STARTS

ALWAYS AT ITS MAXIMAL CAPACITIES, THE BOOSTER ENSURES 100% SUCCESSFUL STARTS.

4 A 3 TIMES LONGER LIFETIME

THE OPTIMAL CHARGE OF THE PROPULSTATION® AVOIDS THE IRREVERSIBLE BATTERY SULFATION WHICH IS CAUSED BY THE BATTERY VOLTAGE DROPPING BELOW 12,4V AND WILL LEAD TO PREMATURE FAILURE OF ITS BATTERY.

5 ABSOLUTE PLEASURE OF USE

THE USER WILL BENEFIT FROM THE UNLIMITED PLEASURE OF WORKING WITH A RELIABLE AND EFFICIENT TOOL.



DOCKING STATION IN 2 VERSIONS



VEHICLE

THE VEHICLE STATION MUST BE CONNECTED TO THE RECOVERY VEHICLE'S BATTERY BY THE DC/DC 12V/12V (OR 24V/24V) LEAD. THIS HAS A ONE-WAY DIODE THAT PREVENTS THE BREAKDOWN VEHICLE FROM DISCHARGING THE BOOSTER. THE LIGHTING AND OTHER EQUIPMENT ON THE BREAKDOWN VEHICLE ARE HEAVY CURRENT CONSUMERS



WORKSHOP

THE WORKSHOP STATION HAS A 230V/12V AC/DC CHARGER TO CONNECT TO THE MAINS. DUE TO THE WEIGHT OF THE PORTABLE BOOSTER 12/24 AND 24V IT IS ADVISED TO MOUNT THE STATION ON THE FLOOR.



PROPULSTATION[®], WHEN IT'S STORED IT'S CHARGED!

THE FIXED DOCKING STATION WILL AUTOMATICALLY CHARGE THE PROPULSTATION[®] WHICH RESULTS IN AN OPTIMIZED POWER SUPPLY.



THE PROPULSTATION HAS TWO ELEMENTS:

- 1) POWERFUL START BOOSTER FOR PROFESSIONAL USE
- 2) CHARGING STATION

TECHNICAL SPECIFICATIONS:

MODEL	12V/800CA	12V/1200CA	24V/1200CA	12/24V 2400/1200CA	12/24V 3200/1600CA	24V 1600CA
VOLTAGE	12V	12V	24V	12/24V	12/24V	24V
CRANKING AMPS	800A	1200A	1200A	2400/1200A	3200/1600A	1600A
PIEK AMPS	2370A	3100A	3100A	6200/3100A	7750/3875A	3875A
CABLE LENGTH	1,55 M	1,55 M	1,35 M	1,35 M	2,10 M	2,10 M
RADAFLEX WELDING CABLE SIZE	35MM ²	50MM ²	50MM ²	50MM ²	70MM ²	70MM ²
CLAMPS	650A	850A	850A	850A	850A	850A
INTERNAL FUSE ON THE BATTERY	300A	300A	500A	500A	500A	500A

PROPULSTATION (BOOSTER + CHARGING STATION)

ART. NO.	EXECUTION	SPECIFICATION
• 48114	VEHICLE	12V 800CA DC/DC
• 48115	VEHICLE	12V 1200CA DC/DC
• 48116	GARAGE	12V 800CA AC/DC
• 48117	GARAGE	12V 1200CA AC/DC
• 48120	VEHICLE	24V 1200CA DC/DC
• 48121	VEHICLE	12/24V 2400/1200CA DC/DC
• 48122	GARAGE	24V 1200CA AC/DC
• 48123	GARAGE	12/24V 2400/1200CA AC/DC
• 48127	GARAGE	12/24V 3200/1600CA AC/DC
• 48128	VEHICLE	12/24V 3200/1600CA AC/DC
• 48129	GARAGE	24V 1600CA AC/DC
• 48130	VEHICLE	24V 1600CA AC/DC



LOOSE CHARGING STATIONS

- 48118 CHARGING STATION FOR VEHICLE 12V
- 48119 CHARGING STATION FOR GARAGE 12V
- 48124 CHARGING STATION FOR VEHICLE 24V OR 12/24V
- 48125 CHARGING STATION FOR GARAGE 24V OR 12/24V



CHARGING STATION

ACCU-SMART® BATTERY CHARGER

DID YOU KNOW THAT YOUR BATTERIES SUFFER FROM SELF-DISCHARGE?

LEAD BATTERIES GET DISCHARGED EVEN WITHOUT BEING USED! THE LOSS OF CAPACITY CAN REACH UP TO 6% PER MONTH (AT 20°C) AND EVEN MORE BY HIGHER TEMPERATURE. YET BELOW 12,4V, LEAD BATTERIES START TO SULPHATE. THE MORE ONE BATTERY IS DISCHARGED AND THE LONGER IT STAYS DISCHARGED, THE MORE SULPHATE COVERS THE LEAD PLATES INSIDE. THIS SULPHATE WILL CORRODE THE LEAD AND DAMAGE THE BATTERY IRREVERSIBLY. MOREOVER, CONTRARY TO OTHER TYPES OF BATTERIES, LEAD BATTERIES DO NOT SUFFER FROM MEMORY EFFECT AND MUST BE CHARGED AS OFTEN AS POSSIBLE. IDEALLY, THE RECHARGE MUST BE PERMANENT AND DONE WITH AN ELECTRONIC AUTOMATIC CHARGER. ACCU-SMART® IS THEREFORE THE ESSENTIAL TOOL FOR PROFESSIONALS AND PRIVATE USERS HAVING VEHICLES STOPPED. THESE ARE A FEW EXAMPLES:

- OLD TIMER CARS AND MOTORBIKES ■ AGRICULTURAL AND GARDEN VEHICLES ■ LEISURE VEHICLES, MOTOR HOMES ■ BOATS
- VEHICLES IN SHOWROOMS IN STOCK OR ON PARKING LOTS ■ RENTAL VEHICLES ■ MOUNTAIN VEHICLES

LIGHT, COMPACT AND POWERFUL:

THE ACCU-SMART®, ELECTRONIC "SWITCHED-MODE" BATTERY CHARGER OFFERS A MUCH GREATER LIGHTNESS, COMPACTNESS AND POWER COMPARED TO THE OLD CHARGERS USING 'LINEAR-MODE TECHNOLOGY' WITH TRANSFORMERS.

TOTAL SECURITY DURING RECHARGE:

THE ACCU-SMART® CHARGERS RESTART IN CASE OF POWER CUT AND GIVE A TOTAL PROTECTION AGAINST:

- SHORT-CIRCUITS
- PEAKS OF VOLTAGE (AC OR DC)
- INVERSION OF POLARITY
- OVERHEATING
- SPIKES

THEY ARE ALSO PERFECTLY SAFE FOR THE ELECTRONICS OF THE VEHICLES; IT IS THEREFORE NOT NECESSARY TO DISCONNECT THE BATTERY FROM THE VEHICLE BEFORE CHARGING IT.

PLEASURE AND EASINESS OF USE:

NO NEED OF HANDLING OR MODE SELECTION, THE CHARGER WORKS AUTOMATICALLY, WITHOUT EXTERNAL INTERVENTION. THE ACCU-SMART® DISPOSES OF A REGULATOR WHICH ALLOWS THE TOTALLY SECURE CHARGING OF THE BATTERY, CONTRARY TO THE CHARGERS WITH OLDER TECHNOLOGIES. ONCE CONNECTED, THE ACCU-SMART® MANAGES AND REGULATES THE CHARGE OF THE BATTERY. YOU CAN LEAVE IT CONNECTED ON THE BATTERY CONTINUOUSLY FOR MONTHS OR YEARS.

ADAPTED ACCESSORIES FOR ALL APPLICATIONS!

THE ACCU-SMART® CHARGERS ARE DELIVERED WITH INTERCHANGEABLE ACCESSORIES ALLOWING AN EASIER CONNECTION. A WATERPROOF END-FITTING ALLOWS YOU TO PLUG THE CONNECTOR THAT SUITS BEST YOUR APPLICATION:

EYELETS:
TO BE CONNECTED ON THE BATTERY TERMINALS WHEN THEY ARE DIFFICULT TO REACH. IDEAL FOR A LONG-TERM CONNECTION.

CIGAR-LIGHTER PLUG:
TO RECHARGE THE VEHICLE'S BATTERY THROUGH THE 12V OUTLET.

CROCODILE CLAMPS:
FOR A UNIVERSAL CONNECTION.



4 STEPS FOR AN OPTIMAL RECHARGE

1 DIAGNOSIS AND RECONDITION

THE CHARGER ANALYSES THE BATTERY AUTOMATICALLY AND CHECKS ITS VOLTAGE. A PULSE CHARGE WILL START FOR THE RECONDITION OF SLIGHTLY SULPHATED BATTERIES.

2 CHARGING

DURING THE STEP OF RECHARGE, THE VOLTAGE SUPPLIED TO THE BATTERY INCREASES AND THE CHARGER DELIVERS A MEDIUM TO HIGH CHARGING CURRENT IN ORDER TO REACH 80% RECHARGE OF THE BATTERY.

3 ABSORPTION

DURING ABSORPTION STEP, THE CHARGER SUPPLIES A CONSTANT VOLTAGE UP TO A COMPLETE RECHARGE OF THE BATTERY.

4 MAINTENANCE

ONCE THE BATTERY IS FULLY CHARGED, THE CHARGING VOLTAGE DECREASES IN ORDER TO REACH MAINTENANCE VOLTAGE. THIS KEEPS THE BATTERY AT FULL CHARGE AND READY TO USE.

TECHNICAL SPECIFICATIONS:

MODEL	12V-2A	12V-4A	12V-7A	12V-10A	24V-3.5A
ARTICLE NUMBER	4811256	4811257	4811258	4811263	4811259
CHARGING TENSION	14,4V MAX.	14,4V MAX.	14,4V MAX.	14,4V MAX.	28,8V MAX.
NOMINAL AC VOLTAGE 220-240VAC-50/60HZ	MAX. 39W	MAX. 70W	MAX. 130W	MAX. 175W	MAX. 130W
MAXIMAL CHARGING CURRENT	2 A	4 A	7 A	10 A	3,5 A
LENGTH OF AC CORD	± 1,70M	± 1,70M	± 1,70M	± 1,70M	± 1,90M
LENGTH OF DC CORD	± 1,90M	± 1,90M	± 1,90M	± 1,90M	± 1,90M
WATER AND DUST INSULATION	EQUIV. IP 65	EQUIV. IP 65	EQUIV. IP 65	EQUIV. IP 65	EQUIV. IP 65
SIZE OF THE CHARGER (CM)	19(L) X 6,5(B) X 4,5(H)	19(L) X 6,5(B) X 4,5(H)	23,3(L) X 9,5(B) X 5,6(H)	23,3(L) X 9,5(B) X 5,6(H)	23,3(L) X 9,5(B) X 5,6(H)
WEIGHT OF THE CHARGER	0,45KG	0,58KG	0,90KG	1,2KG	0,70KG
MAX. CURRENT CONSUMER	24W	36W	72W	90W (TBC)	72W

PORTABLE POWER PACKS

THE SONIC PORTABLE POWER PACKS ARE SMALL ENOUGH TO STORE IN YOUR DASHBOARD LOCKER OR CENTRAL CONSOLE OF YOUR CAR. IT HAS ENOUGH POWER TO CRANK START EVERY 12V BATTERY IN ONLY A FEW MINUTES. THIS WAY, IT'S EASY AND SIMPLE TO CRANK START YOUR BATTERY IN CASE OF EMERGENCY. THE SONIC LITHIUM POLYMER POWER PACK IS ALWAYS READY TO USE. CHARGE YOUR MOBILE PHONE, LAPTOP AND OTHER ELECTRICAL DEVICES. A WIDE VARIETY OF CHARGING CONNECTORS ARE INCLUDED.

48134



LITHIUM POLYMER POWER BANK

48135



DIFFERENT ADAPTERS INCLUDED

MULTI-FUNCTION JUMP STARTER 12000MAH

GENERAL INFORMATION

- SIZE : 210 X 54 X 54MM
- WEIGHT : 395G
- INPUT : 14V 1A
- OUTPUT : 5V 2A, 12V 10A
- STARTING CURRENT : 150A
- PEAK CURRENT : 300A
- FULL CHARGING TIME : 1 HOURS

48137



DIFFERENT ADAPTERS INCLUDED

POWER PACK WITH LCD SCREEN 15000MAH

GENERAL INFORMATION

- SIZE : 181,3 X 95 X 40,3MM
- WEIGHT : 607G
- INPUT : 14V 1A
- OUTPUT : 5V 2A, 12V 10A
- STARTING CURRENT : 250A
- PEAK CURRENT : 500A

Timing Tools



SONIC
TIMING
TOOLS

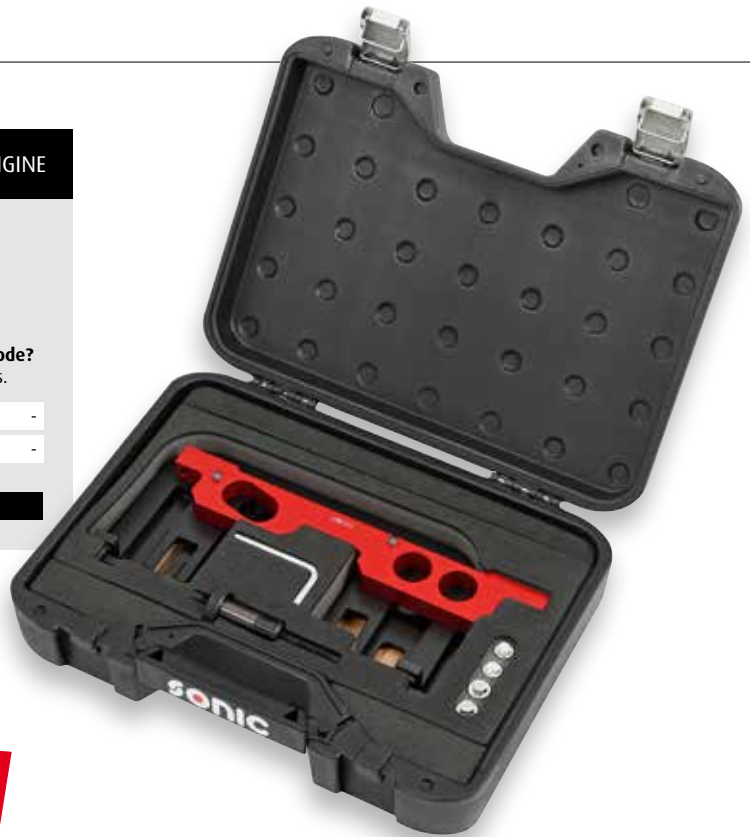

SONIC equipment
SONIC TIMING TOOLS SEARCH ENGINE

We would like to help you find the right Engine timing locking tools for the job. Complete the fields below to return a list of timing tools required for your vehicle and where possible Laser Tools sets that meet your requirements.

Make:	<input style="width: 100%;" type="text"/>	-			
Model:	<input style="width: 100%;" type="text"/>	-			Know your Engine Code or OEM Toolcode?
Year:	<input style="width: 100%;" type="text"/>	-			Fill in a field below to get a list of tools.
Engine size:	<input style="width: 100%;" type="text"/>	-	Engine code:	<input style="width: 100%;" type="text"/>	-
Engine code:	<input style="width: 100%;" type="text"/>	-	OEMToolcode:	<input style="width: 100%;" type="text"/>	-

FIND TOOL

RESET

i MORE INFO WWW.SONIC-EQUIPMENT.COM

ALWAYS A SOLUTION

09



WITH OUR ACCURATE TIMING TOOL DATABASE, WHICH IS BASED ON AUTODATA, YOU WILL FIND THE RIGHT TOOL TO WORK WITH BY SEARCHING FOR: OE NUMBER, VEHICLE SELECTION OR ENGINE CODE.

829015

ENGINE TIMING KIT FIAT, OPEL, SAAB JTD DIESEL - 1.6, 1.9, 2.0, 2.4

THE 829015 ENGINE TIMING KIT HAS BEEN PUT TOGETHER TO PROVIDE THE ESSENTIAL CRANKSHAFT AND CAM SHAFT TIMING PINS ONLY FOR THE FIAT/OPEL JTD DIESEL ENGINES FOUND ACROSS THE FIAT, OPEL, SAAB RANGES.

COMPONENTS			
REF	ART. NO.	OEM	DESCRIPTION
1	4880188	1.870.896.900, EN-46789, 32 025 008	CAMSHAFT ALIGNMENT TOOL
2	4880136	1.860.898.000	FLYWHEEL LOCKING TOOL
3	4880137		STUD ASSY
4	4880218		M8 X 20 SOCKET HEAD SCREW
5	4880091	1.860.965.000	SETTING PIN (CHEM. BLACK) (6 X 60)
6	4880187	1.860.905.000, 1.860.905.010, 2.000.003.000, EN-46788, 32 025 009	CRANKSHAFT ALIGNMENT TOOL

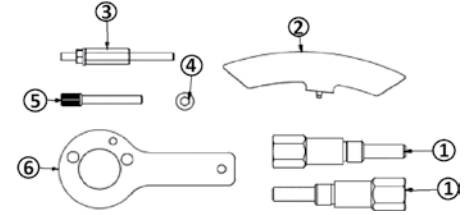

829016

ENGINE TIMING & REBUILD SET FIAT, OPEL, FORD, PSA JTD DIESEL - 1.3

829016 HAS BEEN DEVELOPED TO ALLOW THE USER TO CHANGE THE CAM CHAIN ON THE LATER 1.3 JTD/CDTI & HDI DIESEL ENGINES FOUND IN THE PSA, FIAT, FORD, SUZUKI AND OPEL RANGES.

COMPONENTS			
REF	ART. NO.	OEM	DESCRIPTION
1	4880200	1 871 000 200, 303-1469, KM-662-C	CRANKSHAFT PULLEY FLANGE HOLDING TOOL
2	4880004	1 870 900 400	TIMING CHAIN TENSIONING TOOL
3	4880005	0104-C, 1 870 900 300, 303-1468	CRANKSHAFT ALIGNMENT TOOL
4	4880183	0104-A, 1 871 000 900, 1 860 985 000, EN 46781, 09917-68610	CAMSHAFT ALIGNMENT TOOL ASSY.
5	4880186	EN 46785, 09912-38300	CRANKSHAFT PIN ASSY
6	4880096	FIAT 8MM PIN	LOCKING PIN (8MM DIA. 70 LONG)

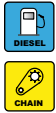
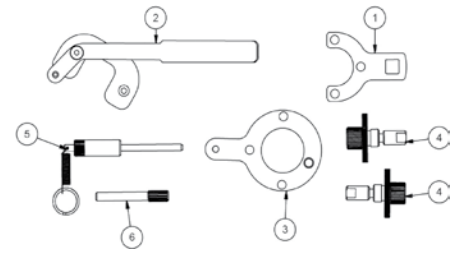

829017

ENGINE TIMING KIT OPEL, CHEVROLET, FIAT PETROL - 1.6, 1.8 16V

829017 HAS BEEN DEVELOPED TO ALLOW THE USER TO CHANGE THE CAM BELT ON THE LATER Z AND A CODED GM PETROL BELT DRIVEN ENGINES. THESE ENGINES ARE ALSO FOUND IN FIAT AND ALFA ROMEO VEHICLES AS LISTED BELOW.

COMPONENTS			
REF	ART. NO.	OEM	DESCRIPTION
1	4880234	KM-6625	FLYWHEEL HOLDING TOOL (KM-6625)
2	4880168	KM-911	FLYWHEEL LOCKING TOOL ITEM 2
3	4880185	KM6130, KM6349	AUXILIARY DRIVE BELT TENSIONER LOCKING PIN (4 X 55)
4	4880239	KM-6628A, 2 000 012 000	CAMSHAFT LOCKING TOOL (GM)
5	4880057	KM-6340, 2 000 012 100	CAM LOCKING TOOL (PAIR)
6	4880058	KM-6333	LOCKING PIN

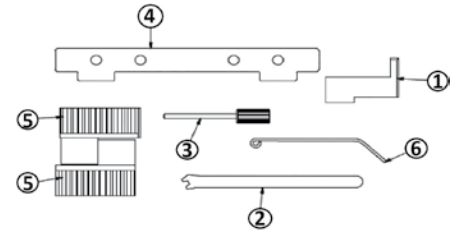

829018

ENGINE TIMING KIT FIAT, PSA, IVECO JTD DIESEL - 2.8

THE 829018 HAS BEEN DEVELOPED FOR FIAT 2.8 DIESEL ENGINES THAT ARE FOUND IN THE FIAT, IVECO AND PSA VAN RANGES. THIS KIT PROVIDES ALL THE TOOLS REQUIRED TO SET THE TIMED COMPONENTS WHEN REPLACING THE TIMING BELT. THE KIT ALSO INCLUDES THE COMPONENTS REQUIRE TO LOCK THE FLYWHEEL WHEN UNDOING AND TIGHTENING UP THE FRONT PULLEY FIXINGS AS WELL AS THE SPECIAL SPACER TO HOLD THE BELT TENSIONER IN ITS FULLY RETRACTED POSITION.

COMPONENTS			
REF	ART. NO.	OEM	DESCRIPTION
1	4880237	1 870 765 001	FLYWHEEL LOCKING PIECE (FIAT)
2	4880090	1 860 617 000	SETTING PIN 5.0MM (5 X 50)
3	4880097	8MM PIN	LOCKING PIN (8MM DIA X 60)
4	4880132	1 860 638 000	TENSIONING TOOL

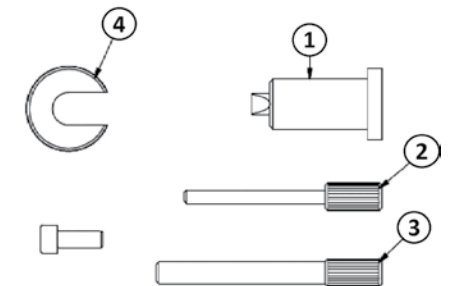

829019

ENGINE TIMING KIT FIAT T JET PETROL - 1.2, 1.4

THE 829019 HAS BEEN DEVELOPED TO LOCK THE CAM AND CRANKSHAFT IN POSITION TO ALLOW THE REMOVAL AND REPLACEMENT OF THE TIMING BELT FITTED TO THE 1,2/1.4 T-JET FIAT PETROL ENGINES.

COMPONENTS			
REF	ART. NO.	OEM	DESCRIPTION
1	4880182	1 860 992 000	PISTON HEIGHT GAUGE
2	4880183	1 860 985 000, 1 871 000 900	CAMSHAFT ALIGNMENT TOOL ASSY.
3	4880184	1 860 987 000	TENSION WRENCH
4	4880233	2 000 015 800	SPIGOT LOCK ASSEMBLY
5	4880006	2 000 004 500	CRANKSHAFT ALIGNMENT TOOL

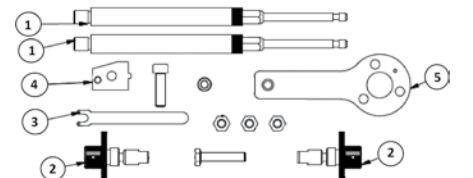

829020

ENGINE TIMING KIT FIAT MULTI AIR PETROL - 1.4

THE 829020 HAS BEEN DEVELOPED TO LOCK THE CAM AND CRANKSHAFT IN POSITION TO ALLOW THE REMOVAL AND REPLACEMENT OF THE TIMING BELT FITTED TO THE CURRENT GENERATION 1.4 FIAT MULTI AIR ENGINES.

COMPONENTS

REF	ART. NO.	OEM	DESCRIPTION
1	4880006	2 000 004 500	CRANKSHAFT ALIGNMENT TOOL
2	4880137	2 190 754 200	STUD ASSY
3	4880263	2 000 034 400	FIAT/ALFA MULTI AIR CAMSHAFT LOCKING TOOL ASSY
4	4880184	1 860 987 000	TENSION WRENCH
5	4880218		M8 X 20 SOCKET HEAD SCREW

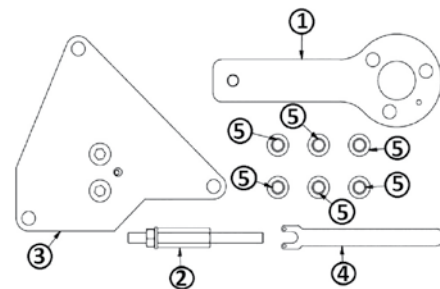

829021

ENGINE TIMING KIT FIAT TWIN AIR PETROL - 0.9

THE 829021 HAS BEEN DEVELOPED FOR THE TWIN AIR TURBO 0.9L FIAT PETROL ENGINE FOUND IN FIAT, ALFA ROMEO AND LANCIA VEHICLES.

COMPONENTS

REF	ART. NO.	OEM	DESCRIPTION
1	4880266	2 000 035 100	FIAT/ALFA TWIN AIR CAMSHAFT LOCKING TOOL
2	4880265	2 000 035 200	TIMING PIN FOR FIAT TWIN AIR 0.9 TIMING SET - STRAIGHT
3	4880264	2 000 035 300	TIMING PIN FOR FIAT TWIN AIR 0.9 TIMING SET - BENT
4	4880165		M8 X 25MM SOCKET HEAD CAP SCREW

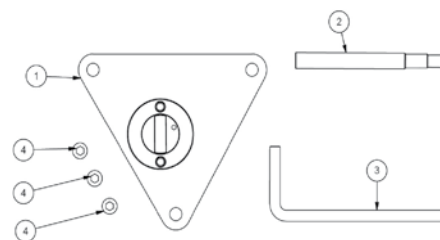

829022

TWIN CAMSHAFT LOCKING TOOL OPEL, FIAT PETROL - 2.2

THE 829022 CONSISTS OF 2 COMPONENTS, THE CAMSHAFT LOCKING TOOL AND TENSIONER PIN REQUIRED TO ALIGN THE ENGINE COMPONENTS OF THE OPEL/FIAT/RENAULT 2.2 TWIN CAM 16V PETROL ENGINE.

COMPONENTS

REF	ART. NO.	OEM	DESCRIPTION
1	4880179	KM 6148	CAMSHAFT LOCKING TOOL (ASSEMBLED)
2	4880180	KM 6077	TENSION PIN 1.0

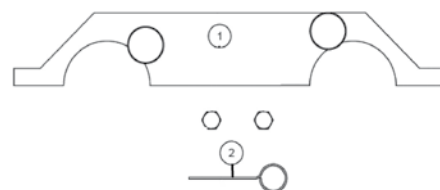

829023

ENGINE TIMING KIT FORD, PSA, FIAT TDCI, HDI DIESEL - 1.4, 1.5, 1.6

THE 829023 IS AN ENGINE TIMING KIT SPECIFICALLY DESIGNED FOR THE FORD/PSA 1.4/1.6 TDCI/HDI DIESEL ENGINES FOUND ACROSS THE FORD, PSA AND FIAT RANGES.

COMPONENTS

REF	ART. NO.	OEM	DESCRIPTION
1	4880090	303-732, 21-260	SETTING PIN 5.0MM (5 X 50)
2	4880096	303-735, 21-263	LOCKING PIN (8MM DIA. 70 LONG)
3	4880064	303-734, 21-262	FLYWHEEL LOCKING PIN (12 X 55)
4	4880061	303-393, 21-168	FLYWHEEL LOCKING TOOL-FORD
5	4880062	303-393-01	TOOTH BLOCK ITEM 2
6	4880063	303-293-02	SHORT TOOTH BLOCK

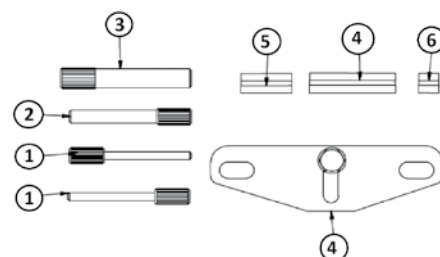

829024

ENGINE TIMING KIT FIAT, FORD PETROL - 1.2 8V

THE 829024 IS AN ENGINE LOCKING KIT DESIGNED FOR THE FIAT 1.2 PETROL ENGINES.

COMPONENTS

REF	ART. NO.	OEM	DESCRIPTION
1	4880184	1 860 987 000	TENSION WRENCH
2	4880007	2 000 004 400, 2 190 754 400	CAMSHAFT ALIGNMENT STRAP - MACHINED
3	4880008	2 000 004 200, 2 190 754 200	CAMSHAFT SPROCKET LOCKING TOOL
4	4880009	2 000 004 300	CAMSHAFT COVER ALIGNMENT TOOL
5	4880006	2 000 004 500, 2 190 754 500	CRANKSHAFT ALIGNMENT TOOL
6	4880202		SKT HD CAPSCREW M10X20
7	4880010		WASHERS M6 FORM C ZC.PL.
8	4880329		M6 SET SCREW 30MM LONG ZINC
9	4880332		M8 X 20 H.T.SETSCREW

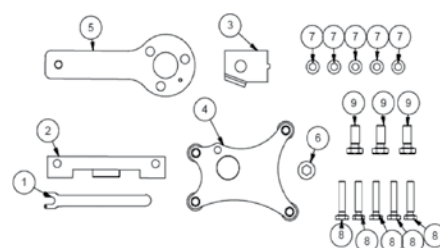

829025

ENGINE TIMING KIT FIAT JTD DIESEL - 2.3, 3.0

THE 829025 IS AN ENGINE TIMING LOCKING TOOL SET FOR FIAT DUCATO 2.3 JTD THIS KIT INCLUDES THE LATEST CRANKSHAFT TIMING PIN REQUIRED ON ENGINES PRODUCED FROM 2006-2008. THE 2.3 JTD TWIN CAMSHAFT COMMON RAIL DIESEL ENGINES ARE BELT DRIVEN BETWEEN CRANKSHAFT AND INLET CAMSHAFT BUT UTILISE A CHAIN TO CONNECT BOTH CAMSHAFTS.

COMPONENTS

REF	ART. NO.	OEM	DESCRIPTION
1	4880130	99360614	CAMSHAFT ALIGNMENT BARREL ASSEMBLY
2	4880131	99360615	CRANKSHAFT TIMING PIN
3	4880090	1 860 617 000	SETTING PIN 5.0MM (5 X 50)
4	4880001	2 000 018 200	BALANCER SHAFT LOCKING SCREW - ROVER/HONDA

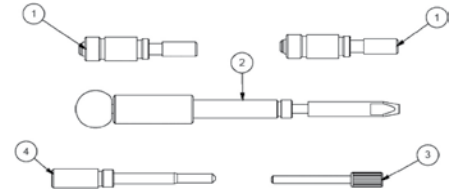

829026

ENGINE TIMING KIT FIAT, PSA, OPEL, IVECO JTD DIESEL - 2.5

THE 829026 IS A SMALL DIESEL LOCKING KIT SPECIFICALLY ASSEMBLED TO COVER THE 2.5/2.8 BELT DRIVEN DIESEL ENGINES FOUND IN THE CITROËN, PEUGEOT, RENAULT AND FIAT RANGES.

COMPONENTS

REF	ART. NO.	OEM	DESCRIPTION
1	4880132	1 860 638 000	TENSIONING TOOL
2	4880095	1 870 667 000, 1 870 765 001	LOCKING PIN (ZINC PL.)
3	4880090	1 860 617 000	SETTING PIN 5.0MM (5 X 50)

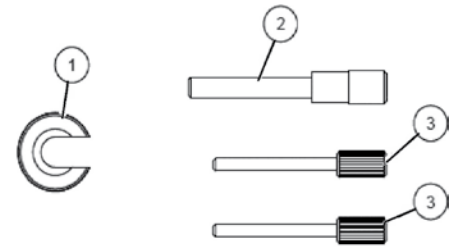

829027

ENGINE TIMING KIT BMW DIESEL M47 - 2.0

THE 829027 HAS BEEN DEVELOPED TO ALLOW THE ENGINE TIMING TO BE SET ON THE BMW M47 2.0L, 2.5L 4 CYLINDER DIESEL ENGINES AND THE 3.0L 6 CYLINDER DIESEL ENGINES FOUND IN BMW'S, ROVER 75 AND LAND ROVER FREELANDER TD4 CIRCA PRE 2010.

COMPONENTS

REF	ART. NO.	OEM	DESCRIPTION
1	4880018	11-2-300, LRT-12-108, LRT-12-171	CRANKSHAFT LOCKING PIN
2	4880022	11-6-320	CAMSHAFT SETTING CLAMP
3	4880024	11-3-340	4MM LOOP PIN (ZINC PLATED)
4	4880023	11-6-322	LOCKING CLAMP ASSEMBLY
5	4880038	11 5 180, LRT 12-227	FLYWHEEL LOCKING PIN TYPE 1 (BMW 115 180)
6	4880039	11 6 080	FLYWHEEL LOCKING PIN BODY TYPE 2 (BMW 116 080)

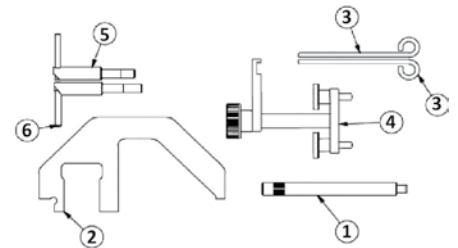

829028

ENGINE TIMING KIT BMW PETROL N51, 52, 53, 54 - 2.3, 2.5, 2.8, 3.0 6 CYLINDER

THE 829028 HAS BEEN DEVELOPED TO ALLOW THE CAMSHAFTS, VANOS UNITS AND CRANKSHAFT TO BE LOCKED IN THEIR TIMED POSITION ON THE APPLICATIONS LISTED BELOW. APPLICATIONS: BMW

COMPONENTS

REF	ART. NO.	OEM	DESCRIPTION
1	4880259	11 4 280, 11 4 281, 11 4 282, 11 4 283, 11 4 285	CAMSHAFT ALIGNMENT TOOL (N51 & N52)
2	4880060	11 4 290, 11 8 520	4.0MM SETTING PIN
3	4880059	11 0 300	SETTING PIN(MM23060 03A)
4	4880261	11 4 280, 11 4 281, 11 4 283	CAMSHAFT LOCKING PLATE FOR N53 & N54 ENGINES ASSEMBLY
5	4880026	11 9 340	TIMING CHAIN PRE-TENSIONING TOOL ASSEMBLY (11 9 340)
6	4880028		M6 X 30 HEX HEAD SETSCREW
7	4880010		WASHERS M6 FORM C ZC.PL.
8	4880047		WASHER M8 ZINC PLATED
9	4880211		M7 X 20 SET SCREW

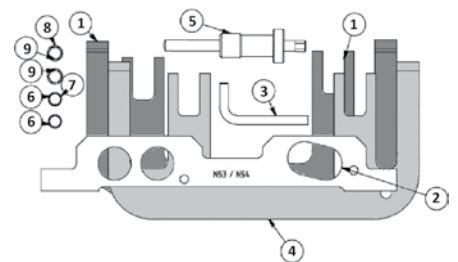

829029

ENGINE TIMING KIT BMW PETROL N43 - 1.6, 2.0

THE 829029 HAS BEEN DEVELOPED TO ALLOW THE USER TO LOCK THE CAMSHAFTS AND CRANKSHAFT IN POSITION ON THE BMW N43 CHAIN DRIVEN PETROL ENGINES. THE N43 ENGINES ARE FOUND IN 1.6 AND 2.0 VERSIONS FROM AROUND 2006 UP TO THE PRESENT DAY. THIS IS A 7 PIECE KIT (NOT INCLUDING FIXINGS) WHICH INCLUDE A CAMSHAFT ALIGNMENT TOOL/LOCKING PLATE, A CAMSHAFT SENSOR ALIGNMENT TOOL, A CRANKSHAFT SETTING/LOCKING PIN, A TIMING CHAIN PRE-TENSIONING TOOL, A BALANCE SHAFT LOCKING PLATE AND 2 TENSIONER LOCKING PINS.

COMPONENTS

REF	ART. NO.	OEM	DESCRIPTION
1	4880025	11 5 120	CRANKSHAFT SETTING PIN-BMW
2	4880026	11 9 340	TIMING CHAIN PRE-TENSIONING TOOL ASSEMBLY (11 9 340)
3	4880024	11 3 340	4MM LOOP PIN (ZINC PLATED)
4	4880257	11 8 710 (11 8 711 11 8 712)	BMW CAMSHAFT POSITION SENSOR TOOL ASSY (N43)
5	4880256	11 8 690 (11 8 691 11 8 692, 11 8 693)	CAMSHAFT ALIGNMENT TOOL (N43)
6	4880258	11 8 700	BALANCER SHAFT ALIGNMENT TOOL (N43)
7	4880169		M6X16 HT SETSCREW-S/COL
8	4880028		M6 X 30 HEX HEAD SETSCREW
9	4880010		WASHERS M6 FORM C ZC.PL.

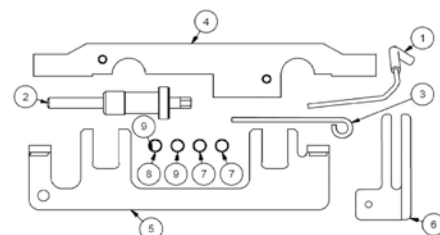

829030

ENGINE TIMING KIT BMW, PSA PETROL N12, N14 -1.4, 1.6

THE 829030 HAS BEEN DEVELOPED TO ALLOW THE REMOVAL AND FITTING OF THE CAMSHAFT DRIVE CHAINS ON THE PSA/MINI 1,4 AND 1,6 PETROL ENGINES.

COMPONENTS

REF	ART. NO.	OEM	DESCRIPTION
1	4880035	11 9 540 / 0197-A3	CAMSHAFT ALIGNMENT TOOL BODY TYPE 2 (OF 2)
2	4880034	119540 / 0197-A3	CAMSHAFT ALIGNMENT TOOL BODY TYPE 1 (OF 2)
3	4880036	11 9 540 / 0197-A1	CAMSHAFT ALIGNMENT TOOL ITEM 1 OF 2 (OEM 119 540QC4 ITEM 1)
4	4880030	11 9 550 / 0197-A2	CAMSHAFT ALIGNMENT TOOL (119 550/551) INLET SETTING PLATE
5	4880031	11 9 551	CAMSHAFT ALIGNMENT PLATE (OEM 119 550/551 - EXHAUST SETTING)
6	4880032	11 9 552	SUPPORT CLAMP BMW (OEM 119 550/ 552)
7	4880026	11 9 340	TIMING CHAIN PRE-TENSIONING TOOL ASSEMBLY (11 9 340)
8	4880134		M6 X 30 HEX HEAD SETSCREW BLACK (SELF COLOUR)
9	4880028		M6 X 30 HEX HEAD SETSCREW
10	4880322		SHANK BOLT 6 X12XMS THREAD
11	4880033	11 9 590 / 0197-B	CRANKSHAFT SETTING PIN G.A-BMW
12	4880181		M6 X 20 H T SETSCREW S/C
13	4880216		M6X30 CAP HEAD SCREW

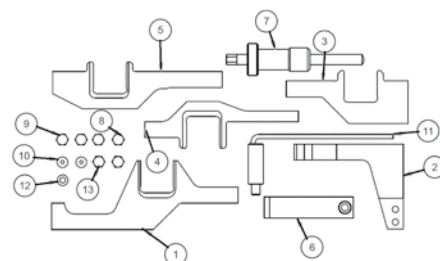

829031

ENGINE TIMING KIT BMW PETROL N42, 46 - 1.6, 1.8, 2.0

THE 829031 HAS BEEN DEVELOPED FOR THE 1.6/1.8/2.0 BMW PETROL ENGINES FOUND IN THE BMW 3, 5, X AND Z4 SERIES VEHICLES UP TO 2014.

COMPONENTS

REF	ART. NO.	OEM	DESCRIPTION
1	4880018	11 5 120, 11 2 300	CRANKSHAFT LOCKING PIN
2	4880025	11 9 190	CRANKSHAFT SETTING PIN-BMW
3	4880020	11 9 340	LARGE BUSH - PRELOAD TOOL
4	4880029	11 9 292	INLET CAMSHAFT ALIGNMENT TOOL-BMW 1181/1201
5	4880043	11 9 350	N42/ N46 VANOS SENSOR GEAR ALIGNMENT TOOL
6	4880027	11 9 291	EXHAUST CAMSHAFT ALIGNMENT TOOL ASSY.
7	4880021		SCREW PRE LOAD TOOL ITEM 2
8	4880010		WASHERS M6 FORM C ZC.PL.
9	4880028		M6 X 30 HEX HEAD SETSCREW
10	4880114		M6 X 55 H.T. SETSCREW S/COL
11	4880165		M8 X 25MM SOCKET HEAD CAP SCREW

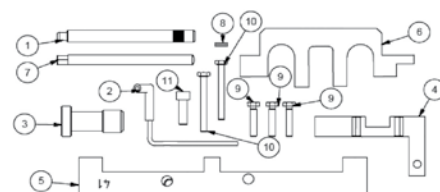

829032

ENGINE TIMING KIT BMW PETROL N40, 45, 45T - 1.6

THE 829032 HAS BEEN DEVELOPED TO ALLOW THE USER TO CHECK AND ADJUST THE CAMSHAFT TIMING AND REMOVE/REPLACE THE CAM CHAIN. THE 829032 ALSO INCLUDES THE VANOS PLATE WHICH IS REQUIRED TO LOCK THE VARIABLE VALVE TIMING SYSTEM IN THE CORRECT POSITION.

COMPONENTS

REF	ART. NO.	OEM	DESCRIPTION
1	4880042	11 7 252	CAMSHAFT LOCKING TOOL INLET SIDE (OEM 11 7 252)
2	4880019		SCREW PRE LOAD TOOL
3	4880020	11 9 340, 11 9 341	LARGE BUSH - PRELOAD TOOL
4	4880040	11 7 260	N40/ N45 VANOS SENSOR GEAR ALIGNMENT TOOL OEM 11 7 260
5	4880041	11 7 251	CAMLOCK PLATE ASSEMBLY EXHAUST SIDE (OEM 117 250)
6	4880028		M6 X 30 HEX HEAD SETSCREW
7	4880025	11 9 190	CRANKSHAFT SETTING PIN-BMW
8	4880165		M8 X 25MM SOCKET HEAD CAP SCREW
9	4880114		M6 X 55 H.T. SETSCREW S/COL
10	4880010		WASHERS M6 FORM C ZC.PL.

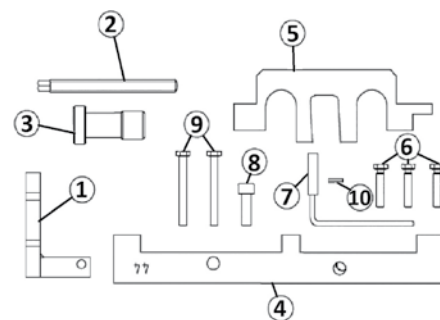

829033

ENGINE TIMING KIT BMW, MINI DIESEL N47, 475 - 1.6, 2.0, 3.0

THE 829033 HAS BEEN DEVELOPED TO ALLOW THE USER TO CHECK AND ADJUST THE CAMSHAFT TIMING AND REMOVE/REPLACE THE CAM CHAIN ON THE 1,6/2,0 AND 3,0 BMW DIESEL ENGINES FOUND ACROSS THE BMW RANGE.

N.B: FOR SOME APPLICATIONS ADDITIONAL CRANKSHAFT HOLDING TOOL OEM 11 4 320 MAY BE REQUIRED. SOLD SEPARATELY AS SONIC NUMBER: 829102
FRONT CRANKSHAFT HOLDING OEM 11 7 220 TOOL AVAILABLE SEPARATELY AS SONIC 829105.

COMPONENTS

REF	ART. NO.	OEM	DESCRIPTION
1	4880044	11 6 480	CRANKSHAFT PULLEY TURNING TOOL (11 6 480)
2	4880045	11 8 740	HI PRESSURE PUMP SPROCKET RETAINER (11 8 740)
3	4880046	11 5 320	FLYWHEEL PLATE TIMING PIN (OEM 11 5 320)
4	4880037	11 8 760	CAMSHAFT ALIGNMENT TOOL BMW OEM 11 8 760
5	4880024	11 3 340	4MM LOOP PIN (ZINC PLATED)

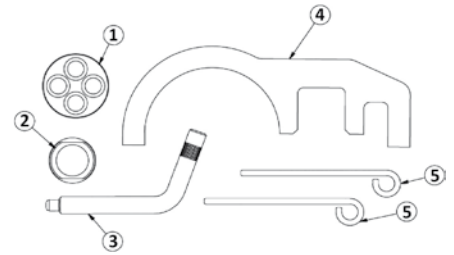

829034

ENGINE TIMING KIT BMW PETROL N62, 73 - 3.6, 4.0, 4.4, 4.8, 6.0, V8, V12

THE 829034 HAS BEEN DEVELOPED FOR BMW N62 V8 AND N73 V12 ENGINES. THE 829034 KIT ALLOWS THE USER TO CHECK AND HOLD THE VALVE TIMING WHILST MAINTAINING THE CORRECT TIMED POSITION OF THE CAMSHAFTS AND CRANKSHAFT.

COMPONENTS

REF	ART. NO.	OEM	DESCRIPTION
1	4880025	11 9 190	CRANKSHAFT SETTING PIN-BMW
2	4880207	11 9 461	BMW INLET CAMSHAFT GAUGE PLATE (OEM 11 9 461)
3	4880208	11 9 462	BMW EXHAUST CAMSHAFT GAUGE PLATE (OEM 11 9 462)
4	4880209	11 9 463	CLAMP ASSEMBLY (N62 / N73)

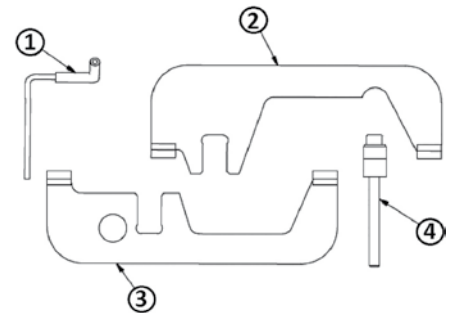

829035

ENGINE TIMING KIT PSA PETROL - 1.4

THE 829035 HAS BEEN DEVELOPED TO OFFER THE REQUIRED ENGINE LOCKING TOOLS TO FIT THE POPULAR PSA 1.4 BELT DRIVEN 16V AND 8V PETROL ENGINES. FITTED TO THE MODELS LISTED BETWEEN 2000 AND 2013.

COMPONENTS

REF	ART. NO.	OEM	DESCRIPTION
1	4880235	0132QY	FLYWHEEL LOCATING PIN (PSA 0132QY)
2	4880112	4533-TAD/0132-AK	TIMING BELT RETAINING CLIP
3	4880228	3MM PIN	3MM FORMED LOCKING PIN (YELLOW PASSIVATE)
4	4880090	0194-A	SETTING PIN 5.0MM (5 X 50)
5	4880096	4533-TAC1/0132-AJ1	LOCKING PIN (8MM DIA. 70 LONG)
6	4880054	0132RZ/4507-TB	PIN DIA.10 X 80 LONG
7	4880053	4507-TA	SETTING PIN 6 X 140 D

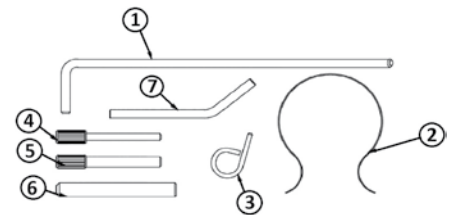

829036

ENGINE TIMING KIT PSA PETROL 3 CYLINDER - 1.0, 1.2

THE 829036 HAS BEEN DEVELOPED FOR THE LATEST GENERATION OF CITROEN/PEUGEOT 1.0LT AND 1.2LT 3 CYLINDER PETROL ENGINES. THE 829036 ENGINE TIMING KIT HAS BEEN DESIGNED TO HOLD THE CAM SHAFTS AND CRANKSHAFT IN THEIR TIMED POSITION DURING BELT REPLACEMENT. THE 829036 IS MADE UP OF A 2 PIECE CAMSHAFT LOCKING BRIDGE AND 1 PIECE CRANKSHAFT SETTING PIN.

COMPONENTS

REF	ART. NO.	OEM	DESCRIPTION
1	4880300	0109-2A	ASSEMBLY DETAIL FOR K00605 PSA 1.0/1.1 VVT 3 CYLINDER TIMING
2	4880303	0109-2B	FLYWHEEL TIMING PIN FOR PSA 1.0 & 1.2 ASSEMBLY
3			(WITH PART 4880300 ITEM 3 WILL AUTOMATICALLY DELIVERED)

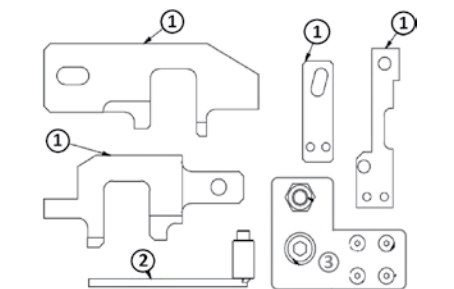

829037

ENGINE TIMING KIT JAGUAR LAND ROVER DIESEL TDV6 - 2.7

THE 829037 ENGINE TIMING KIT ALLOWS THE VALVE TIMING TO BE SET AND MAINTAINED DURING CAM BELT REPLACEMENT ON THE POPULAR JAGUAR/LAND ROVER TDV6 DIESEL ENGINE FOUND ACROSS THE JAGUAR & LAND ROVER RANGES. THE 829037 ALSO INCLUDES THE ADDITIONAL PSA LOCKING TOOLS REQUIRED FOR THE 2.7 HDI ENGINE FOUND IN THE CITROEN AND PEUGEOT RANGES.

COMPONENTS

REF	ART. NO.	OEM	DESCRIPTION
1	4880127	303-1132	CAMSHAFT SPROCKET TIMING PIN
2	4880079	303-1126	CAMSHAFT SPROCKET TIMING PIN
3	4880129	303-1116	FLY WHEEL LOCKING TOOL
4	4880128	303-1117	FLY WHEEL LOCKING TOOL 2
5	4880077	0195-K	FLYWHEEL LOCKING PIN PEUGEOT 0195-K
6	4880078	0195-C	COOLANT PUMP PULLEY PIN PEUGEOT 0195-C

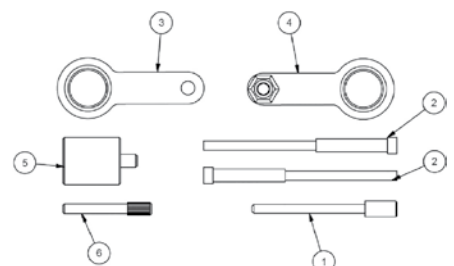

829038

ENGINE TIMING KIT PSA PETROL (EW) - 2.0, 2.2 16V

THE 829038 ENGINE TIMING KIT ALLOWS THE VALVE TIMING TO BE SET AND MAINTAINED DURING CAM BELT REPLACEMENT ON THE POPULAR EW CODED PSA ENGINES USED ACROSS THE CITROËN AND PEUGEOT RANGES.

COMPONENTS

REF	ART. NO.	OEM	DESCRIPTION
1	4880055	0189C	FLYWHEEL LOCKING PIN
2	4880074	0189R	CRANKSHAFT SETTING PIN
3	4880075	0189S1	TENSIONER ADJUSTER - ASSEMBLY
4	4880076	0189S2	TENSION GAUGE
5	4880097	0132AJ2, 0188M, 4533TAC2	LOCKING PIN (8MM DIA X 60)
6	4880090	0132AB, 0178D, 4527-TS2	SETTING PIN 5.0MM (5 X 50)
7	4880096	5711-TD	LOCKING PIN (8MM DIA. 70 LONG)
8	4880099	0189AZ	TIMING PINS ITEM 2
9	4880100	0189L	LOCKING PIN
10	4880098	0189A	TIMING PINS ITEM 1
11	4880112	0188K, 0132AK, 0153AK, 0187J, 4533-TAD	TIMING BELT RETAINING CLIP

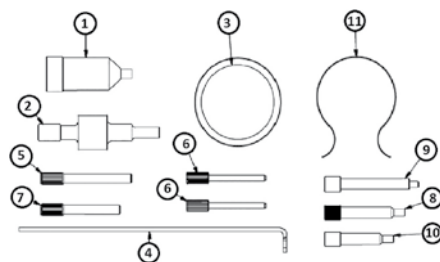

829039

ENGINE TIMING KIT FIAT, OPEL, FORD, PSA JTD DIESEL - 1.3

THE 829039 ENGINE TIMING KIT ALLOWS THE VALVE TIMING TO BE SET ON THE CURRENT 1,3 MULTIJET FIAT DERIVED DIESEL ENGINES FOUND ACROSS THE FIAT, FORD, OPEL & PSA RANGES.

COMPONENTS

REF	ART. NO.	OEM	DESCRIPTION
1	4880135	153A	FLYWHEEL HOLDING TOOL
2	4880183	21 860 985 000, EN 46781, 303-1472, 0104-A	CAMSHAFT ALIGNMENT TOOL ASSY.
3	4880005	1 870 900 300, 303-1468, 0104-C	CRANKSHAFT ALIGNMENT TOOL
4	4880280	303-1475, 1 871 008 600	FORD 1.3 DIESEL CAMSHAFT SUPPORT TOOL Ø36 ID

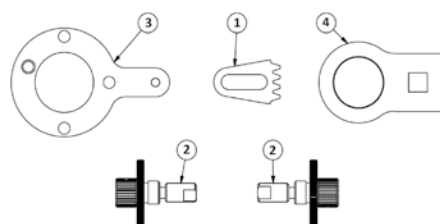

829040

ENGINE TIMING KIT JAGUAR LAND ROVER, FORD, PSA DIESEL DW12 - 2.2

THE 829040 IS A COMPACT TOOL SET WHICH INCLUDES THE CAMSHAFT SPROCKET, FLYWHEEL LOCKING TOOLS AND FLYWHEEL TIMING PIN REQUIRED WHEN SETTING THE VALVE TIMING AND/OR CHANGING THE TIMING BELT ON DW12 (2,2LT) DIESEL ENGINES FOUND IN THE LAND ROVER, FORD, PEUGEOT AND CITROËN RANGES.

COMPONENTS

REF	ART. NO.	OEM	DESCRIPTION
1	4880096	303-1277, 0188.M	LOCKING PIN (8MM DIA. 70 LONG)
2	4880061	303-1272, 0188.F	FLYWHEEL LOCKING TOOL-FORD
3	4880068	303-1270, 303-1059	TIMING PIN
4	4880080	0188AH	CENTRALISER SPRING - 1.4MM DIA
5	4880106	0188F	FLYWHEEL LOCK (ZINC PL.)

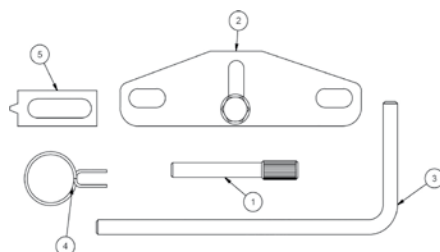

829041

ENGINE TIMING & REBUILD SET PSA, FIAT DW10, DW12 - 2.0, 2.2

THE 829041 KIT BRINGS TOGETHER THE TOOLS REQUIRED TO SET THE VALVE TIMING ON THE EXTENSIVE RANGE OF DW10 2.0 AND DW12 2.2 DIESEL ENGINES AS WELL AS THE DV4 1,4 AND DV6 1,6 DIESEL ENGINES FOUND ACROSS THE PSA AND FIAT RANGES.

COMPONENTS

REF	ART. NO.	OEM	DESCRIPTION
1	4880072	7099-TM	CRANKSHAFT PIN - 8 X 380
2	4880112	0188K, 0132AK, 0153AK, 0187J, 4533-TAD	TIMING BELT RETAINING CLIP
3	4880113	0188P, 7015-T, 0188P2	PULLER BEAM
4	4880068	303-1059	TIMING PIN
5	4880080	0188AH	CENTRALISER SPRING - 1.4MM DIA
6	4880106	0188F	FLYWHEEL LOCK (ZINC PL.)
7	4880108	0188J2	TENSION ADJ. TOOL
8	4880097	0188M	LOCKING PIN (8MM DIA X 60)
9	4880227	0188Q2	2MM FORMED LOCKING PIN (BZP) 210 X 50
10	4880228	0153AL	3MM FORMED LOCKING PIN (YELLOW PASSIVATE)
11	4880060	0188Q1	4.0MM SETTING PIN
12	4880104	0188J/J1	TENSION ADJ. TOOL
13	4880096	0189B	LOCKING PIN (8MM DIA. 70 LONG)
14	4880090	0178D, 303-732, 0194A	SETTING PIN 5.0MM (5 X 50)
15	4880064	303-734, 0194C	FLYWHEEL LOCKING PIN (12 X 55)
16	4880255	0.532Y, 9967.34	8MM MULTI-BEND FLYWHEEL TIMING PIN

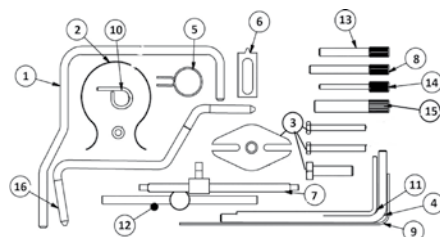

829042

ENGINE TIMING KIT FORD DIESEL TDCI 2.2, 3.2

THE 829042 KIT HAS BEEN DEVELOPED SPECIFICALLY FOR THE CHAIN DRIVEN 2.2 COMMON RAIL DIESEL ENGINES FITTED IN THE FORD TRANSIT FROM AROUND 2006 WITH THE ENGINE NUMBERS LISTED ON OUR WEBSITE.
THE 829042 IS A 4 PIECE KIT CONSISTING OF THE COMPONENTS REQUIRED TO LOCK THE CRANKSHAFT AND CAM SPROCKETS IN THEIR TIMED POSITION TO ALLOW THE REMOVAL AND REPLACEMENT OF THE CAM CHAIN AND ASSOCIATED COMPONENTS.

COMPONENTS

REF	ART. NO.	OEM	DESCRIPTION
1	4880091	6MM PIN X2	SETTING PIN (CHEM. BLACK) (6 X 60)
2	4880066	303-698 / 21-251	TIMING PIN
3	4880273	303-1587	FORD 2.2/2.3 GLOBAL PUMA TDC SETTING TOOL ASSEMBLY - PREVIOUS

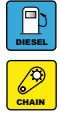
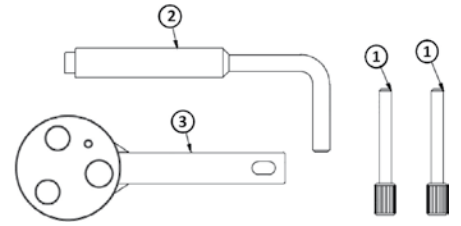

829043

ENGINE TIMING KIT FORD DURATORQ (TDCI) BELT DRIVEN DIESEL - 1.4, 1.6, 1.8, 2.0

THE 829043 KIT HAS BEEN DEVELOPED SPECIFICALLY DESIGNED FOR THE FORD 1.4LT, 1.6LT, 1.8LT AND 2.0 BELT DRIVEN DIESEL ENGINES.

COMPONENTS

REF	ART. NO.	OEM	DESCRIPTION
1	4880050	303-376B	CAMSHAFT ALIGNMENT STRAP (CHEM. BLACK)
2	4880070	21-104, 303-193	SETTING PIN
3	4880068	303-1059	TIMING PIN
4	4880096	303-735, 21-263	LOCKING PIN (8MM DIA. 70 LONG)
5	4880064	303-734, 21-262	FLYWHEEL LOCKING PIN (12 X 55)
6	4880061	303-393, 21-168	FLYWHEEL LOCKING TOOL-FORD
7	4880062	303-393-01	TOOTH BLOCK ITEM 2
8	4880063	303-393-02	SHORT TOOTH BLOCK
9	4880090	303-732, 21-260	SETTING PIN 5.0MM (5 X 50)

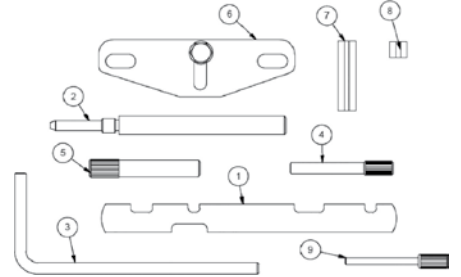

829044

ENGINE TIMING KIT FORD/ VOLVO PETROL - 1.25, 1.4, 1.6, 1.8, 2.0

THE 829044 KIT HAS BEEN DEVELOPED SPECIFICALLY FOR LATE FORD 1.25LT, 1.4LT, 1.6LT, PETROL ENGINES. COVERAGE ALSO INCLUDES SOME 1.8LT, 2.0LT & 2.3LT ENGINES

COMPONENTS

REF	ART. NO.	OEM	DESCRIPTION
1	4880049	21-163, 303-574	CRANKSHAFT LOCKING PIN - FORD (CHEM. BLACK)
2	4880051	21-210, 303-507	MAZDA SCREW
3	4880052	21-259, 303-748	SETTING PIN (CHEM. BLACK)
4	4880274	303-1054	LOCKING PIN
5	4880050	303-376B	CAMSHAFT ALIGNMENT STRAP (CHEM. BLACK)

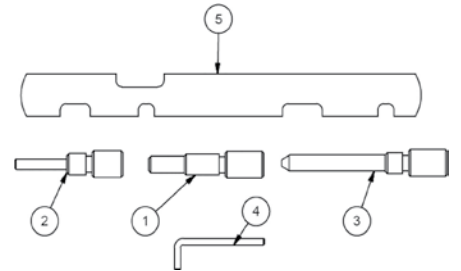

829045

ENGINE TIMING KIT FORD PETROL 16V WITH VCT - 1.6

THE 829045 HAS BEEN DEVELOPED TO PROVIDE THE ESSENTIAL TOOLS REQUIRED TO SET AND TIME THE MAIN ENGINE COMPONENTS WHEN REPLACING THE CAMSHAFT DRIVE BELTS ON THE 1.25/1.4/1.5/1.6 16V PETROL FORD ENGINES.

COMPONENTS

REF	ART. NO.	OEM	DESCRIPTION
1	4880274	303-1054	LOCKING PIN
2	4880049	303-748	CRANKSHAFT LOCKING PIN - FORD (CHEM. BLACK)
3	4880069	303-1097	CAMSHAFT SPROCKET LOCKING TOOL 303-1097
4	4880050	303-376B	CAMSHAFT ALIGNMENT STRAP (CHEM. BLACK)

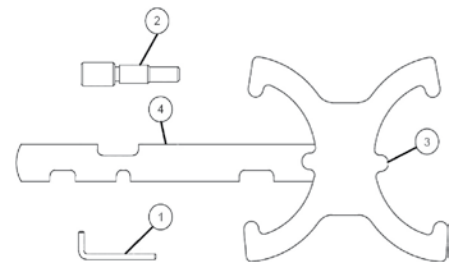

829046

ENGINE TIMING KIT MAZDA, FORD PETROL - 1.8, 2.0, 2.3

THE 829046 KIT HAS BEEN DEVELOPED TO ALLOW THE USER TO LOCK THE CAM AND CRANKSHAFT IN POSITION TO ALLOW THE REMOVAL AND REPLACEMENT OF THE TIMING CHAIN FITTED TO THE TWIN CAM ENGINES FITTED TO THE FORD AND MAZDA RANGES AS LISTED ON OUR WEBSITE.

COMPONENTS

REF	ART. NO.	OEM	DESCRIPTION
1	4880267	49 UN30 310610, 303-1061	MACHINING DETAIL FOR FORD DURATEC CAMSHAFT ALIGNMENT BRACKET
2	4880051	999 7152/49JE01 061, 303 507, 21-210	MAZDA SCREW
3	4880052	49N010 101/MOT 1430 303 620, 999 7201, 21-163	SETTING PIN (CHEM. BLACK)
4	4880050	999 7151, 303 376 49JE01 054, 303 367//21 162, 49UN30 3376	CAMSHAFT ALIGNMENT STRAP (CHEM. BLACK)

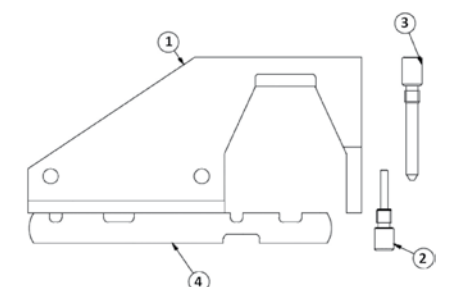

829047

ENGINE TIMING KIT FORD SCTI ECOBOOST PETROL - 2.0

THE 829047 KIT HAS BEEN DEVELOPED SPECIFICALLY FOR THE 2.0 DIRECT INJECTION CHAIN DRIVEN PETROL ENGINES FITTED WITH VARIABLE VALVE TIMING AND FOUND IN BOTH THE FORD AND VOLVO RANGES. 829047 IS A 5 PIECE ENGINE TIMING KIT DESIGNED FOR THE FORD 2.0 DIRECT INJECTION ECOBOOST PETROL ENGINES FOUND IN THE FORD FOCUS, MONDEO AND S-MAX. DEVELOPED TO ALLOW THE TIMING CHAIN TO BE REPLACED WHILST LOCKING THE CRANKSHAFT AND CAMSHAFTS IN THEIR CORRECT TIMED POSITIONS. THE 829047 ALSO INCLUDES THE CRANKSHAFT POSITION SENSOR ALIGNMENT TOOL.

COMPONENTS

REF	ART. NO.	OEM	DESCRIPTION
1	4880245	303-1565	FORD GTDI M14 CAMSHAFT ALIGNMENT TOOL ASSY
2	4880248		DIA. 2.0 MM TENSIONER PIN
3	4880278	303-1504	FORD 2.0 CAMSHAFT ALIGNMENT TOOL
4	4880281	303-1521	FORD CRANKSHAFT SENSOR ALIGNMENT TOOL (CKP)
5	4880049	303-748	CRANKSHAFT LOCKING PIN - FORD (CHEM. BLACK)

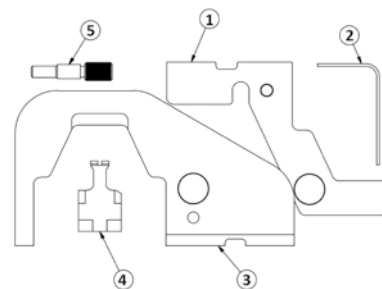

829048

ENGINE TIMING KIT FORD, VOLVO SCTI ECOBOOST PETROL - 1.6

THE 829048 KIT HAS BEEN DEVELOPED SPECIFICALLY FOR THE 1.6 DIRECT INJECTION PETROL ENGINES FITTED WITH VARIABLE VALVE TIMING AND FOUND IN BOTH THE FORD AND VOLVO RANGES. 829048 IS A 4 PIECE KIT CONSISTING OF THE COMPONENTS REQUIRED TO LOCK THE CRANKSHAFT AND CAM PULLEYS IN THEIR TIMED POSITION TO ALLOW THE REMOVAL AND REPLACEMENT OF THE CAMSHAFT TIMING BELT. THE 829048 ALSO INCLUDES THE CRANKSHAFT FRONT PULLEY ALIGNMENT TOOL.

COMPONENTS

REF	ART. NO.	OEM	DESCRIPTION
1	4880249	303-1054	DIA. 3.0MM TENSIONER PIN
2	4880270	303-1550, 999-7431	FORD 1.6 ECOBOOST CRANKSHAFT PULLEY ALIGNMENT TOOL ASSEMBLY
3	4880049	303-748, 999-7406	CRANKSHAFT LOCKING PIN - FORD (CHEM. BLACK)
4	4880069	303-1097, 999-7429	CAMSHAFT SPROCKET LOCKING TOOL 303-1097

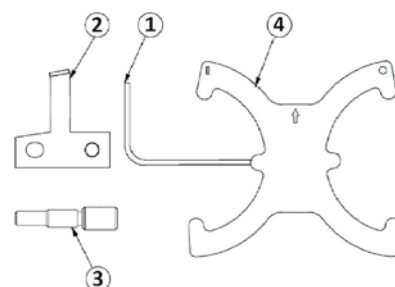

829049

ENGINE TIMING KIT FORD, PSA DIESEL TDCI, HDI - 1.4, 1.6

THE 829049 KIT HAS BEEN DEVELOPED SPECIFICALLY FOR THE FORD 1.4 AND 1.6 COMMON RAIL DIESEL ENGINES WITH THE ENGINE NUMBERS LISTED ON OUR WEBSITE. THE 829049 IS A 4 PIECE KIT CONSISTING OF THE COMPONENTS REQUIRED TO LOCK THE CRANKSHAFT AND CAM PULLEYS IN THEIR TIMED POSITION TO ALLOW THE REMOVAL AND REPLACEMENT OF THE CAM BELT AND ASSOCIATED COMPONENTS.

COMPONENTS

REF	ART. NO.	OEM	DESCRIPTION
1	4880096	0194-B, 21-263, 303-735	LOCKING PIN (8MM DIA. 70 LONG)
2	4880090	0194-A, 21-260, 303-732	SETTING PIN 5.0MM (5 X 50)
3	4880064	0194-C, 21262, 303-734	FLYWHEEL LOCKING PIN (12 X 55)

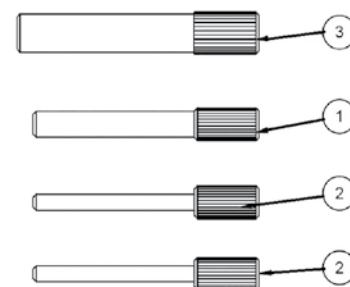

829050

ENGINE TIMING & FUEL PUMP SETTING KIT FORD, LSV DIESEL - 2.0. 2.4

THE 829050 KIT HAS BEEN DEVELOPED SPECIFICALLY FOR THE FORD/LDV/JAGUAR 2.0LT, 2.2LT, 2.4LT AND 3.2 LT DIESEL ENGINES.

COMPONENTS

REF	ART. NO.	OEM	DESCRIPTION
1	4880240	303-249-01	FUEL PUMP REMOVER LEG ASSEMBLY
2	4880241	303-249-01	CENTER LOCATION PLUG FOR DIESEL PUMP REMOVER
3	4880296	303-682	FORD ENGINE FRONT COVER ALIGNMENT TOOL 303-682
4	4880066	303-698	TIMING PIN
5	4880091		SETTING PIN (CHEM. BLACK) (6 X 60)
6	4880279	303-705, 303-1093	FORD OIL PUMP ALIGNMENT TOOL-LASERCUT PLATED
7	4880014	303-249-01	PULLER CENTRE SCREW
8	4880013	303 249	PULLER BEAM
9	4880331		M8 X 55LG 1.25P - ZINC - SET SCREW
10	4880191	303-679	FUEL PUMP COVER TOOL BODY
11	4880047		WASHER M8 ZINC PLATED
12	4880065	303-675	FLYWHEEL LOCKING PIN
13	4880064	303-734	FLYWHEEL LOCKING PIN (12 X 55)
14	4880090	303-732	SETTING PIN 5.0MM (5 X 50)
15	4880096	303-735	LOCKING PIN (8MM DIA. 70 LONG)
16	4880144		TENSIONER LOCKING PIN 1.4MM BZP & CLEAR PASSIVATE
17	4880190	303-1151	303-1151 LOCKING TOOL
18	4880273	303-1587	FORD 2.2/2.3 GLOBAL PUMA TDC SETTING TOOL ASSEMBLY - PREVIUO

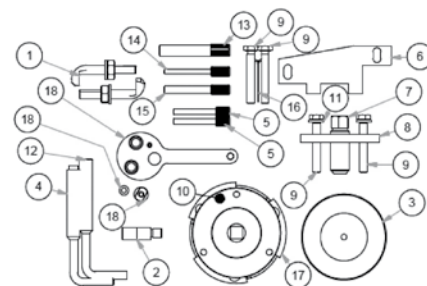

829051

ENGINE TIMING KIT FORD PETROL GTDI ECOBOOST - 1.0

SPECIFICALLY DESIGNED FOR THE NEW FORD 1.0LT 3 CYLINDER ECOBOOST ENGINES. THE 829051 KIT OFFERS THE TIMING TOOLS REQUIRED FOR REPLACEMENT OF THE OIL BATHED CAMSHAFT DRIVE BELT ON THESE ENGINES.

NOTE: WHERE THE VCT PULLEYS REQUIRE REMOVING OR SETTING THE ADDITIONAL KIT PART NUMBER 829050 WILL BE REQUIRED.

COMPONENTS

REF	ART. NO.	OEM	DESCRIPTION
1	4880253	303-1604	FORD 1.01 - GTDI CRANKSHAFT TIMING PIN
2	4880254	303-1602	LARGE TOOTH BLOCK VERSION OF MM 23060 10 - O.E.M 303.1602
3	4880274	303-1054	LOCKING PIN
4	4880096	8MM TENSIONER PIN	LOCKING PIN (8MM DIA. 70 LONG)
5	4880242	303-1605/1	ASSEMBLY DETAILS FOR 303-1605/1 CAMSHAFT LOCKING TOOL
6	4880243	303-1606/2	ASSEMBLY DETAILS FOR 303-1606/2 CAMSHAFT LOCKING TOOL
7	4880238	303-1603	FORD OIL SEAL INSTALLER
8	4880121	4MM TENSIONER PIN	AUXILIARY BELT TENSIONER LOCKING PIN
9	4880084	303-732	DTI EXTENSION ITEM 3

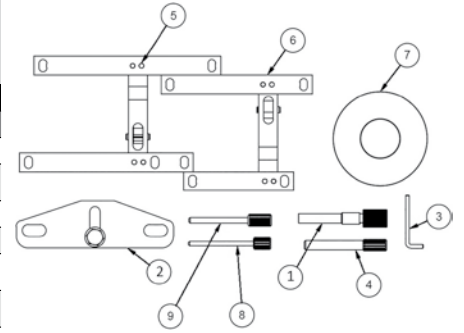

829052

VARIABLE VALVE SETTING KIT FORD PETROL VCT ECOBOOST - 1.0

SPECIFICALLY DESIGNED FOR THE NEW FORD 1.0LT 3 CYLINDER ECOBOOST ENGINES. AND USED IN CONJUNCTION WITH 829051 TO ASSEMBLE THE VCT (VARIABLE CAMSHAFT TIMING) UNITS ON THE CAMSHAFTS IN THEIR TDC POSITION WITHOUT PLAY. REQUIRED TO ALIGN THE VCT UNITS WHEN THEY ARE ASSEMBLED ON THE CAMSHAFTS.

COMPONENTS

REF	ART. NO.	OEM	DESCRIPTION
1	4880246	303-1606-1	VARIABLE CAMSHAFT TIMING LOCKING TOOL ASSEMBLY - INLET 303-1
2	4880247	303-1606 -2	VARIABLE CAMSHAFT TIMING LOCKING TOOL ASSEMBLY - EXHAUS T 30

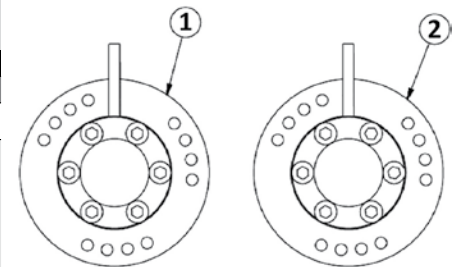

829053

ENGINE TIMING KIT HONDA PETROL SOHC/DOHC - 1.6, 1.8, 2.0, 2.2, 2.3, 3.0

THE 829053 HAS BEEN DESIGNED TO OFFER NOT ONLY THE SPECIAL TOOLS LISTED BY HONDA FOR THE APPLICATIONS LISTED BUT ALSO THE CORRECTLY SIZED M6 BOLT THAT IS REQUIRED TO LOCK THE SPRUNG LOADED CAM BELT TENSIONERS FOUND ON MANY OF THE LISTED APPLICATIONS.

COMPONENTS

REF	ART. NO.	OEM	DESCRIPTION
1	4880236	14540-P13-003	TENSION LOCKING TOOL FOR HONDA 87 ONWARDS
2	4880001	07LAG-PT20100 / 18G1671	BALANCER SHAFT LOCKING SCREW - ROVER/HONDA
3	4880090	07744-0010400	SETTING PIN 5.0MM (5 X 50)
4	4880073		HT SETSCREW M6 X 45 ZC.PL.

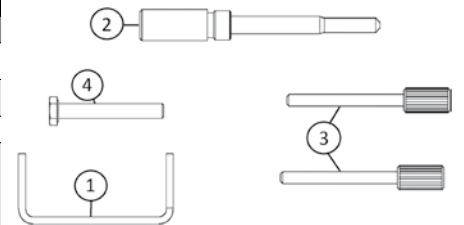

829054

ENGINE TIMING KIT RENAULT/NISSAN PETROL (K4) - 1.6, 2.0

THE 829054 OFFERS THE ESSENTIAL ENGINE TIMING TOOLS REQUIRED FOR THE RENAULT PETROL 16V BELT DRIVEN 1.6L AND 2.0L ENGINES. THE 829054 KIT OF FOUR TOOLS ENABLES THE CORRECT ENGINE TIMING TO BE PERFORMED ON RENAULT K4J, K4M & F4P, F4R ENGINES, WHEN CHANGING THE TIMING BELT. THE SET INCLUDES 2 CRANKSHAFT TIMING PINS AND CAMSHAFT SETTING BAR WITH THE BRACKET SPECIFICALLY FOR THE K4M 813 ENGINE FROM 2003 ONWARDS.

COMPONENTS

REF	ART. NO.	OEM	DESCRIPTION
1	4880048	MOT 1489	CRANKSHAFT LOCKING PIN (CHEM. BLACK)
2	4880095	MOT 1054	LOCKING PIN (ZINC PL.)
3	4880109	MOT 1496	CAMSHAFT SETTING BAR - RENAULT
4	4880111	MOT 1750	MOUNTING BRACKET (MOT 1759)

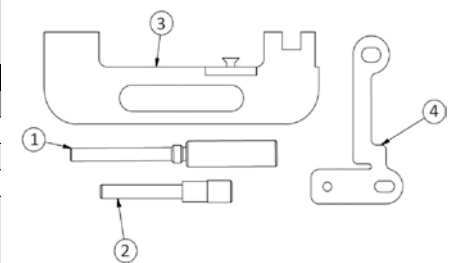

829055

ENGINE TIMING KIT RENAULT/ OPEL/ NISSAN DIESEL (BELT DRIVE) - 1.5, 1.9, 2.2, 2.3, 2.5

THE 829055 OFFERS THE ESSENTIAL ENGINE TIMING TOOLS REQUIRED FOR THE RENAULT BELT DRIVEN DCI RANGE OF DIESEL ENGINES. IT INCLUDES THE TOOLS REQUIRED FOR 1.5, 1.9, 2.2, 2.3 AND 2.5 DCI DIESEL ENGINES FOUND IN THE DACIA, NISSAN, RENAULT, SUZUKI AND OPEL/VAUXHALL RANGES.

COMPONENTS

REF	ART. NO.	OEM	DESCRIPTION
1	4880048	MOT 1489	CRANKSHAFT LOCKING PIN (CHEM. BLACK)
2	4880047		WASHER M8 ZINC PLATED
3	4880073		HT SETSCREW M6 X 45 ZC.PL.
4	4880095	MOT 1054	LOCKING PIN (ZINC PL.)
5	4880096	MOT 1430	LOCKING PIN (8MM DIA. 70 LONG)
6	4880116	MOT 1543	TENSIONING TOOL - RENAULT 19 DCI
7	4880174	MOT 1538	HIGH PRESSURE PUMP PIN C/W T/BAR
8	4880175	MOT 1536 KM6203	CRANKSHAFT TIMING PIN (7 X 80)
9	4880177		H.T. SETSCREW M8X60 ZINC PLATE
10	4880178	MOT 1534 KM6205	INLET CAM SETTING TOOL (CHEM. BLACK)
11	4880176	MOT 1537 KM6205	EXHAUST CAM SETTING TOOL

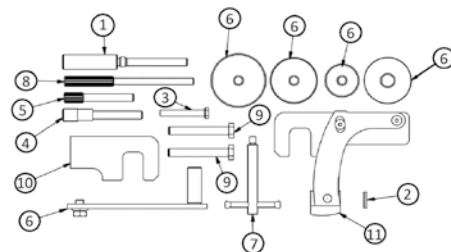

829056

ENGINE TIMING KIT RENAULT/ OPEL/ NISSAN DIESEL (CHAIN DRIVE) - 1.6, 2.0, 2.3

THE 829056 HAS BEEN SPECIFICALLY PUT TOGETHER TO ALLOW THE USER TO LOCK THE ENGINE COMPONENTS OF THE 1.6, 2.0 AND 2.3 RENAULT ENGINES USED ACROSS THE RENAULT, OPEL AND NISSAN RANGES. THE 829056 KIT INCLUDES THE ESSENTIAL TOOLS REQUIRED TO ALLOW THE REMOVAL AND REPLACEMENT OF THE ENGINE TIMING CHAIN.

COMPONENTS

REF	ART. NO.	OEM	DESCRIPTION
1	4880122	MOT 1766, EN48330	CRANKSHAFT LOCKING PIN
2	4880119	MOT 1769, EN48332, MOT 1969 (1.6L)	CAMSHAFT SETTING TOOL (MOT 1769)
3	4880121	KM 6130	AUXILIARY BELT TENSIONER LOCKING PIN
4	4880118	MOT 1770, KM 956-1, EN-48334	CRANKSHAFT PULLEY HOLDING TOOL
5	4880120	MOT 1773, EN48331	CAMSHAFT GEAR ALIGNMENT TOOL
6	4880201		LOCKING PIN
7	4880210		4MM HEX KEY
8	4880330		M6 X 40 HT SETSCREW
9	4880293	MOT 1970	CRANKSHAFT TIMING PIN RENAULT OEM MOT1970
10		MOT 1969	FOR 1.6L ENGINES (R9M)
11		MOT 1769	FOR 2.0L/2.3L ENGINES (M9R/M9T)

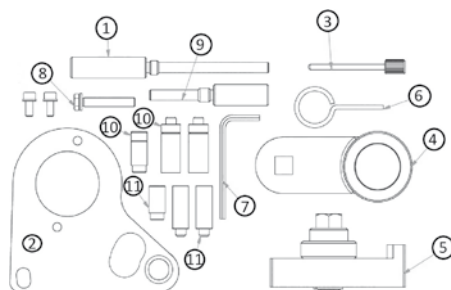

829057

ENGINE TIMING KIT RENAULT/ DACIA PETROL (K7)/K7M) - 1.4, 1.6

THE 829057 HAS BEEN SPECIFICALLY PUT TOGETHER TO ALLOW THE USER TO LOCK THE ENGINE COMPONENTS OF THE 1.4 AND 1.6 RENAULT ENGINES USED ACROSS THE DACIA RANGE. THE 829057 KIT INCLUDES THE BELT PRE-TENSIONER LEVER REQUIRED ON ENGINES EQUIPPED WITH A MANUAL TENSIONER.

COMPONENTS

REF	ART. NO.	OEM	DESCRIPTION
1	4880048	MOT 1489	CRANKSHAFT LOCKING PIN (CHEM. BLACK)
2	4880102	MOT 1145-01	TENSION SPANNER
3	4880295	MOT 1501	ASSEMBLY - BELT TENSIONING TOOL FOR LOGAN, SANDERO MOT 1501

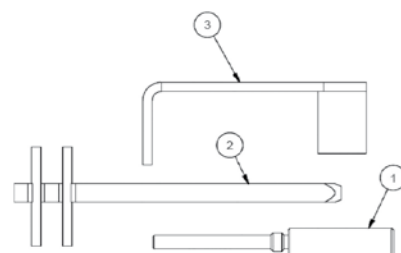

829058

ENGINE TIMING KIT RENAULT PETROL (BELT DRIVE) - 1.4, 1.6, 1.8, 2.0 16V

THE 829058 HAS BEEN SPECIFICALLY PUT TOGETHER TO ALLOW THE USER TO LOCK THE ENGINE COMPONENTS OF THE 1.4, 1.6, 1.8 AND 2.0 16V TURBO AND NON-TURBO PETROL ENGINES.

COMPONENTS

REF	ART. NO.	OEM	DESCRIPTION
1	4880048	MOT 1489	CRANKSHAFT LOCKING PIN (CHEM. BLACK)
2	4880095	MOT 1054	LOCKING PIN (ZINC PL.)
3	4880109	MOT 1496	CAMSHAFT SETTING BAR - RENAULT
4	4880111	MOT 1750	MOUNTING BRACKET (MOT 1759)
5	4880115	MOT 1490	CAMSHAFT PULLEY ALIGNMENT TOOL - RENAULT
6	4880117	MOT 1801	CAMSHAFT SPROCKET LOCKING TOOL - RENAULT 2,0 (ENG. F4R)
7	4880323	MOT 1368	CAMBELT TENSIONING TOOL (3894)

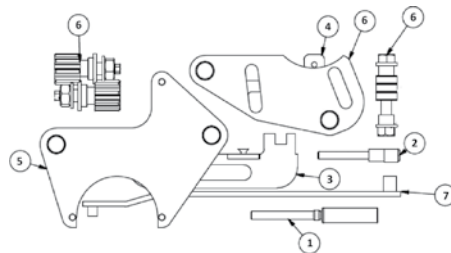

829059

ENGINE TIMING KIT RENAULT PETROL - 1.2

THE 829059 HAS BEEN SPECIFICALLY ASSEMBLED TO PROVIDE THE ESSENTIAL TOOLS FOR BELT REPLACEMENT ON THE RENAULT 1.2 PETROL ENGINES.

COMPONENTS

REF	ART. NO.	OEM	DESCRIPTION
1	4880095	MOT 1054	LOCKING PIN (ZINC PL.)
2	4880103	MOT 1386	TENSIONING TOOL
3	4880307	MOT 582-01	FLYWHEEL LOCKING TOOL - RENAULT CLIO, TWINGO, KANGOO, MEGAN/

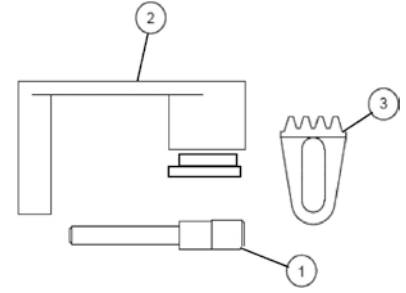

829060

ENGINE TIMING KIT OPEL PETROL (CHAIN DRIVE DOHC (A12/A14) - 1.2, 1.4

THE 829060 HAS BEEN DEVELOPED TO ALLOW THE USER TO LOCK THE CAM AND CRANKSHAFTS IN POSITION TO ALLOW THE REMOVAL AND REPLACEMENT OF THE TIMING CHAIN FITTED TO THE VAUXHALL/OPEL TWIN CAM ENGINES LISTED ON OUR WEBSITE. THE 829060 KIT IS A 7 PIECE TOOL KIT MADE UP OF THE REQUIRED CAMSHAFT AND CRANKSHAFT LOCKING TOOLS.

COMPONENTS

REF	ART. NO.	OEM	DESCRIPTION
1	4880276	EN-49977-200	VAUXHALL CAMSHAFT LOCKING TOOL EN-49977-100
2	4880244	EN-49977-100	CAMS PROCKET LOCKING TOOL (EN-49977-200)
3	4880277	EN-49978	CAMSHAFT LOCKING TOOL (EN-49978)
4	4880170	KM-953-A	CAMSHAFT SETTING PLATE (CHEM. BLACK)
5	4880171	KM-952	FLYWHEEL LOCKING PIN
6	4880173	KM-955-2	TENSIONER LOCATION PIN 4MM
7	4880172	KM-955-1	TENSIONER LOCATION PIN 2.5MM

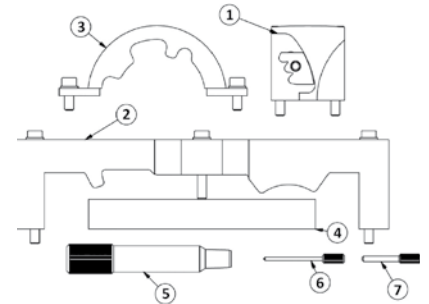

829061

ENGINE TIMING KIT OPEL/CHEVROLET DIESEL (Z20) - 2.0

DEVELOPED FOR THE VAUXHALL/CHEVROLET 2.0 COMMON RAIL DIESEL ENGINE FOUND IN THE VAUXHALL ANTARA, CHEVROLET CAPTIVA, CRUZE, EPICA, LACETTI AND NUBIRA. THIS KIT HOLDS THE CORRECT TIMING POSITION OF THE CRANKSHAFT AND CAMSHAFT WHILST CHANGING THE TIMING BELT ON THE 16V SOHC BELT DRIVEN DIESEL ENGINES.

COMPONENTS

REF	ART. NO.	OEM	DESCRIPTION
1	4880012	EN-48245	CAMSHAFT LOCKING TOOL ASSEMBLY (EN48245)
2	4880011	EN-48246	CRANKSHAFT LOCKING PIN (EN48246)

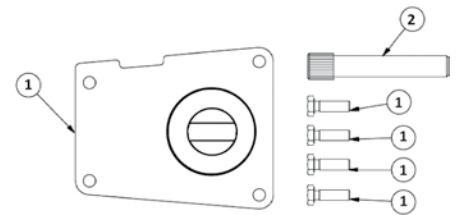

829062

ENGINE TIMING KIT OPEL, RENAULT, SAAB DIESEL DOHC CDTI - 1.9

THE 829062 PROVIDES THE ESSENTIAL TOOLS REQUIRED TO REPLACE THE CAMSHAFT DRIVE BELT AND REMOVE THE CAMSHAFTS ON THE VAUXHALL/OPEL CDTI 1.9/2.0LT TWIN CAM DIESEL ENGINES LISTED BELOW.

COMPONENTS

REF	ART. NO.	OEM	DESCRIPTION
1	4880137	EN-46788	STUD ASSY
2	4880185	KM-6130, 6349	AUXILIARY DRIVE BELT TENSIONER LOCKING PIN (4 X 55)
3	4880187	EN-46788/1, 32 025 009	CRANKSHAFT ALIGNMENT TOOL
4	4880188	EN-46789, 32 025 008	CAMSHAFT ALIGNMENT TOOL
5	4880189	EN-46789-100	CAMSHAFT SETTING PIN ASSY.
6	4880332	SSM8X20B	M8 X 20 H.T.SETSCREW

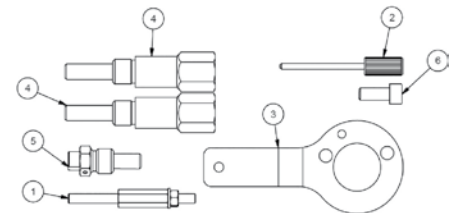

829063

ENGINE TIMING KIT OPEL/FIAT/FORD/PSA DIESEL JTD/HDI - 1.3

THIS IS AN ESSENTIAL ENGINE TIMING TOOL SET THAT PROVIDES THE CAMSHAFT AND CRANKSHAFT TIMING TOOLS ONLY.

COMPONENTS

REF	ART. NO.	OEM	DESCRIPTION
1	4880183	104-A, EN 46781	CAMSHAFT ALIGNMENT TOOL ASSY.
2	4880186		CRANKSHAFT PIN ASSY
3	4880096	EN-46785	LOCKING PIN (8MM DIA. 70 LONG)

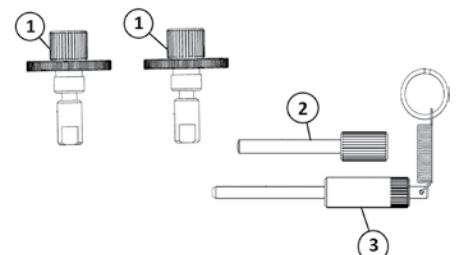

829064

ENGINE TIMING KIT OPEL/CHEVROLET/SAAB PETROL (A20/A24) - 2.0, 2.4

DEVELOPED SPECIFICALLY FOR THE HIGH POWER OUTPUT 2.0 LITRE AND 2.4 LITRE TWIN CAM TURBO CHARGED PETROL ENGINES FOUND ACROSS THE GM, CHEVROLET AND SAAB RANGES. THIS KIT PROVIDES ALL THE COMPONENTS REQUIRED TO SET AND HOLD THE CAMSHAFTS, CRANKSHAFT AND CHAIN TENSIONER COMPONENTS WHEN PERFORMING MAJOR ENGINE WORK OR REPLACING THE CAM CHAIN AND ASSOCIATED COMPONENTS.

COMPONENTS

REF	ART. NO.	OEM	DESCRIPTION
1	4880231	EN-49212, EN-49212-1	VAUXHALL - OPEL - CAMSHAFT LOCKING TOOL LHS (OEM REF: EN-492)
2	4880232	EN-49212, EN-49212-2	VAUXHALL - OPEL - CAMSHAFT LOCKING TOOL RHS (OEM REF: EN-492)
3	4880317	EN-48953	CAMSHAFT ADJUSTER HOLDING TOOL
4	4880318	EN-48585	CRANKSHAFT BOLT HOLE BALANCER
5	4880320	J45027-2, EN45027-2, EN-45027,	TENSION PLUNGER HOLDER
6	4880321	EN-45027-1, J-45027-1	TENSION PLUNGER REMOVER
7	4880319	EN-43653, J43653	FLYWHEEL HOLDING TOOL BOTTOM HALF
8	4880135	EN-43653, J43653	FLYWHEEL HOLDING TOOL
9	4880214		M6 X 50 CAPHEAD SCREW
10	4880010		WASHERS M6 FORM C ZC.PL.
11	4880173	EN-955-20, KM 955-20	TENSIONER LOCATION PIN 4MM
12	4880172	EN-955-10, KM955	TENSIONER LOCATION PIN 2.5MM
13	4880215		M6 X 16 CAP HEAD SCREW SELF-COLOUR TO BS4168

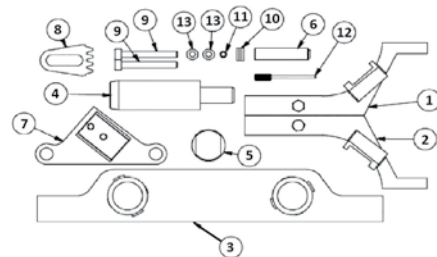

829065

CAMSHAFT ALIGNMENT KIT OPEL/ SAAB PETROL TURBO (Z20/B20) - 2.0

THE 829065 KIT HAS BEEN DEVELOPED TO CHANGE THE CAMSHAFT DRIVE CHAIN ON THE TWIN CAM CHAIN DRIVEN 2.0L TURBO PETROL ENGINES FOUND IN THE VAUXHALL AND SAAB RANGES FROM 2002 TO 2012.

829065 IS AN 4 PIECE KIT CONSISTING OF THE COMPONENTS REQUIRED TO LOCK THE CAMSHAFT, HOLD THE CRANKSHAFT AND SET THE CHAIN TENSIONER WHEN REPLACING THE TIMING CHAIN.

COMPONENTS

REF	ART. NO.	OEM	DESCRIPTION
1	4880298	KM-6362-1 EN-48366-001	CAMBLOCK WITH INLET MARKING FOR VAUXHALL Z20NET ENGINE (2.0L
2	4880299	KM-6362-2 EN-48366-002	CAMBLOCK WITH EXHAUST MARKING FOR VAUXHALL Z20NET ENGINE (2.
3	4880180	KM-6077 83 96 392	TENSION PIN 1.0
4	4880230	KM-J-38122-A 83 96 210	HOLDING TOOL (KM-J-38122-A)

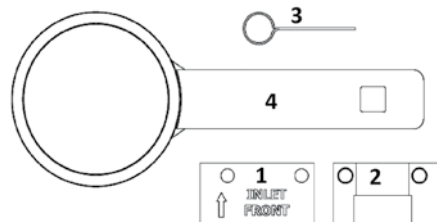

829066

ENGINE TIMING KIT VAG PETROL TFSI - 1.8, 2.0

THE 829066 KIT HAS BEEN DESIGNED TO ALLOW REMOVAL AND REPLACEMENT OF THE TIMING CHAIN AND CAMSHAFT SPROCKETS ON THE 1.8/2.0 TFSI AND TSI PETROL ENGINES COMMONLY FOUND IN THE VOLKSWAGEN AUDI GROUP OF VEHICLES. DESCRIPTION: 829066 IS AN 8 PIECE KIT CONSISTING OF THE COMPONENTS REQUIRED TO FIND PISTON TDC, HOLD THE CAMSHAFT PULLEYS IN POSITION AND LOCK THE CHAIN TENSIONERS IN THEIR RETRACTED POSITIONS.

COMPONENTS

REF	ART. NO.	OEM	DESCRIPTION
1	4880229	T10352	CAMSHAFT CONTROL VALVE TOOL
2	4880268	T40271-1	CAMSHAFT CLAMP FOR VAG 1.8,2.0 4V TFSI TIMING SET - T40271-1
3	4880269	T40271-2	CAMSHAFT CLAMP FOR VAG 1.8, 2.0 4V TFSI TIMING SET- T40271-2
4	4880275	T40265	1.8 & 2.0 4V TFSI VAG TENSION PULLEY LOCKING PIN (T40265)
5	4880144	T40011	TENSIONER LOCKING PIN 1.4MM BZP & CLEAR PASSIVATE
6	4880294	T40267	VAG 1.8, 2.0 4V TFSI TENSIONER LOCKING CLAMP(T40267)
7	4880133	T10170	5MM TDC INDICATOR
8	4880123	VAS6079	DTI -ORD.STYLE C/W TEST CERT.

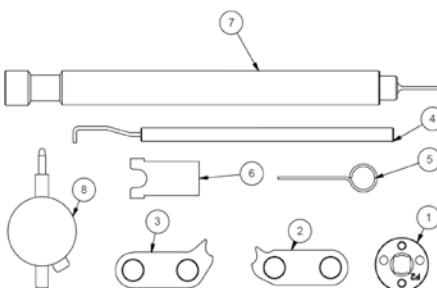

829067

ENGINE TIMING KIT VAG PETROL 3 CYLINDER - 1.0

THE 829067 KIT HAS BEEN DESIGNED TO OFFER THE ESSENTIAL TIMING TOOLS REQUIRED FOR THE 1.0L 2 CYLINDER VAG ENGINES FROM 2011 ON.

DESCRIPTION: 829067 IS A 3 PIECE KIT CONSISTING OF THE COMPONENTS REQUIRED TO LOCK THE CRANKSHAFT, CAM PULLEYS, CAMSHAFTS AND CRANKSHAFT IN THEIR TIMED POSITIONS TO ALLOW THE REMOVAL AND REPLACEMENT OF THE CAMSHAFT TIMING BELT.

COMPONENTS

REF	ART. NO.	OEM	DESCRIPTION
1	4880297	T10477	CAMSHAFT LOCKING TOOL FOR VAG 3 CYL 4V
2	4880199	T10340	LOCKING PIN (T10340)
3	4880324	T10476	CAMSHAFT SPROCKET LOCKING TOOL VAG

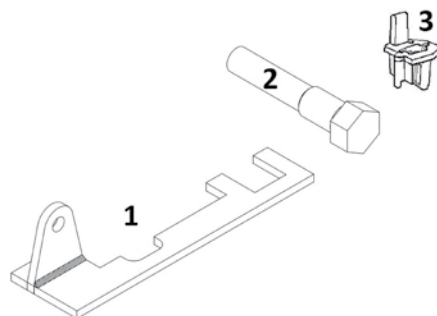

829068

ENGINE TIMING KIT VAG DIESEL CR (2012 ON) - 1.6, 2.0

THE 829068 KIT HAS BEEN DESIGNED TO OFFER THE TIMING TOOLS REQUIRED FOR THE POPULAR 1.6/2.0 TDI VAG ENGINES TO INCLUDE THE LATEST VERSIONS. FROM 2013 ON. THE 829068 IS A 9 PIECE KIT CONSISTING OF THE COMPONENTS REQUIRED TO LOCK THE CRANKSHAFT, CAM PULLEY AND FUEL PUMP PULLEY IN THEIR TIMED POSITIONS TO ALLOW THE REMOVAL AND REPLACEMENT OF THE CAMSHAFT TIMING BELT. 829068 ALSO INCLUDES THE SPECIAL VAG SUMP PLUG REMOVAL TOOL DESIGNED SPECIFICALLY FOR THE PLASTIC SUMP AND TIMING PLUGS USED ON THE LATER 1.6/2.0 TDI CR DIESEL ENGINES.

COMPONENTS

REF	ART. NO.	OEM	DESCRIPTION
1	4880157	T10060A	TENSIONER PIN
2	4880092	3359	INJECTION PUMP TIMING PIN
3	4880152	T10051	PULLEY HOLDING TOOL G.A VAG
4	4880197	T10264	6 MM BALL END HEX KEY
5	4880196	T10265	TENSIONER PULLEY LOCKING PIN ASSY Ø2.5. [T10265]
6	4880304	T10490	MACHINED PLATE FOR CRANKSHAFT POSITIONING/HOLDING TOOL
7	4880096		LOCKING PIN (8MM DIA. 70 LONG)
8	4880305	T10549	VAG 2.0 4CYL SUMP PLUG REMOVER TOOL
9	4880308	T10492	6MM LOCKING PIN

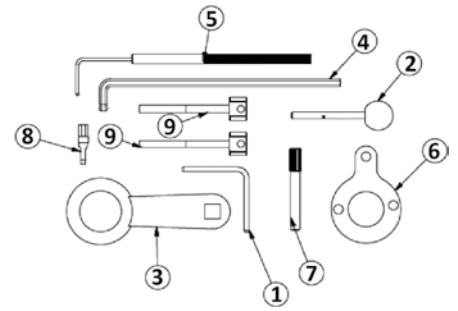

829069

ENGINE TIMING KIT VAG PETROL TSI - 1.2, 1.4

THE 829069 KIT HAS BEEN DESIGNED TO OFFER THE ESSENTIAL TOOLS REQUIRED TO ALLOW THE ENGINE TIMING TO BE SET ON THE NEW GENERATION 1.2/1.4 OF TSI VAG PETROL ENGINES. THE KIT INCLUDES AN SPECIALLY DESIGNED CAM-LOCKING BAR THAT IS EQUIVALENT TO THE OEM TOOLS.

COMPONENTS

REF	ART. NO.	OEM	DESCRIPTION
1	4880309	T10494	VAG CAMSHAFT LOCKING TOOL
2	4880199	T10340	LOCKING PIN (T10340)

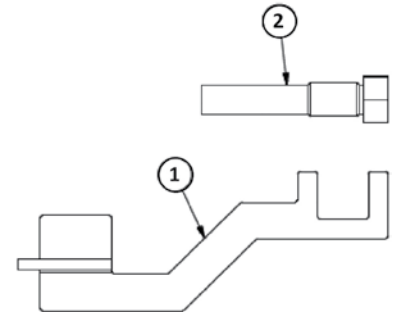

829070

ENGINE TIMING KIT VAG PETROL 3 CYLINDER 6V/12V - 1.2

THE 829070 KIT PROVIDES THE ESSENTIAL TIMING TOOLS REQUIRED WHEN SETTING THE ENGINE TIMING ON THE BELT DRIVEN 3 CYLINDER 1,2 SIX VALVE AND TWELVE VALVE PETROL ENGINES FOUND ACROSS THE VAG RANGES.

COMPONENTS

REF	ART. NO.	OEM	DESCRIPTION
1	4880192	T10123	CAMSHAFT ALIGNMENT TOOL VAG 1.2-12V (OEM T10123)
2	4880194	T10120	CRANK ALIGNMENT PIN (CHEM. BLACK)
3	4880193	T10121	CAMSHAFT ALIGNMENT PIN VAG 1.2-12V(OEM T10120)

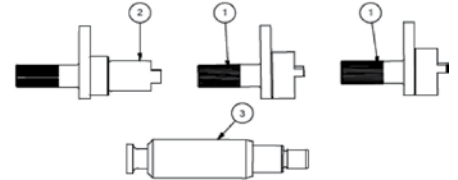

829071

ENGINE TIMING KIT VAG PETROL FSI/TFI - 1.2, 1.4

THE 829071 KIT PROVIDES THE ESSENTIAL TIMING TOOLS REQUIRED WHEN REMOVING THE CAMSHAFT DRIVE CHAINS ON THE 1,2 AND 1,4 FSI/TFI PETROL ENGINES FOUND ACROSS THE VAG RANGES FROM AS EARLY AS 2003 TO 2015. THE KIT ALSO INCLUDES 2 ALIGNMENT PINS USED TO HELP ALIGN THE SUPERCHARGER ON THE ENGINES EQUIPPED WITH A SUPERCHARGER.

COMPONENTS

REF	ART. NO.	OEM	DESCRIPTION
1	4880262	T10414	CAMSHAFT LOCKING TOOL
2	4880123	VAS 6079	DTI -ORD.STYLE C/W TEST CERT.
3	4880133	T10170	5MM TDC INDICATOR
4	4880144	T40011	TENSIONER LOCKING PIN 1.4MM BZP & CLEAR PASSIVATE
5	4880159	T10171//T10171A	CAMSHAFT ALIGNMENT TOOL
6	4880198	T10341	GUIDE (T10341)
7	4880199	T10340	LOCKING PIN (T10340)

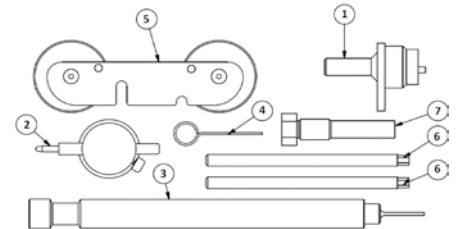

829072

ENGINE TIMING KIT VAG DIESEL TRANSPORTER, LT - 2.4, 2.5

THE 829072 KIT PROVIDES THE ESSENTIAL TIMING TOOLS REQUIRED FOR THE VW 2.4/2.5 DIESEL ENGINES LISTED BELOW.

COMPONENTS

REF	ART. NO.	OEM	DESCRIPTION
1	4880081	2065A	SETTING BRACKET (ZINC PL.)
2	4880146	3355	32MM. HEX WRENCH TENSIONER PULLEY
3	4880145	T50009	MM 23161 15X VW CRAFTER CRANK-SHAFT ALIGNMENT PIN(T50009)
4	4880071	2064	SETTING SPIGOT (CHEM. BLACK) (PIN 15.5 X 67)
5	4880167	T10025	FLYWHEEL SPROCKET HOLDING TOOL (ZINC PL.)

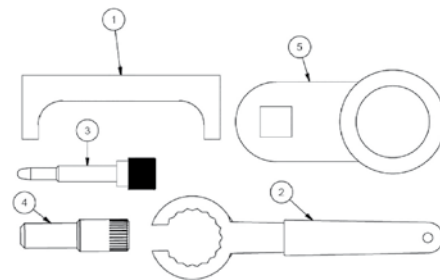

829073

ENGINE TIMING KIT VAG PETROL FSI/TFSI - 2.0

THE 829073 KIT PROVIDES THE ESSENTIAL CAMSHAFT TIMING TOOLS REQUIRED WHEN REMOVING THE CAMSHAFT DRIVE CHAIN IN THE CYLINDER HEAD OF THE 2.0 TFSI AND FSI PETROL ENGINES FOUND ACROSS THE VAG RANGES. THESE ENGINES USE A BELT TO DRIVE ONE CAMSHAFT AND A CHAIN IN THE REAR OF THE HEAD TO DRIVE THE SECOND CAMSHAFT.

COMPONENTS

REF	ART. NO.	OEM	DESCRIPTION
1	4880017	T10020//V.159	TENSIONER
2	4880144	T40011	TENSIONER LOCKING PIN 1.4MM BZP & CLEAR PASSIVATE
3	4880153	T10252	CAMSHAFT SETTING TOOL-VAG FSI T10252
4	4880154	3366	CHAIN TENSIONER RETAINER
5	4880155	T10092	TENSIONER BOLT
6	4880157	T10060/A	TENSIONER PIN

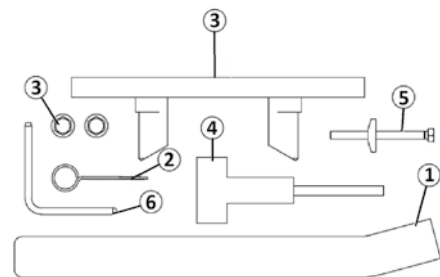

829074

ENGINE TIMING KIT VAG PETROL FSI V6/V8 - 2.4/3.2

THE 829074 KIT HAS THE ESSENTIAL TIMING TOOLS REQUIRED FOR THE 2.4 AND 3.2 V6 FSI ENGINES AS WELL AS THE 5 CYLINDER 2.5 FSI PETROL ENGINES FOUND IN THE AUDI RANGE.

EQUIVALENT TO OEM = T40069, T40070

COMPONENTS

REF	ART. NO.	OEM	DESCRIPTION
1	4880160	T40070	CAMSHAFT ALIGNMENT TOOL VAG T40070
2	4880161	T40069	TDC ALIGNMENT PIN VAG T40069
3	4880162	T40071	CLIP
4	4880047		WASHER M8 ZINC PLATED
5	4880212		M8 X 50 LG BOLT DIN 931

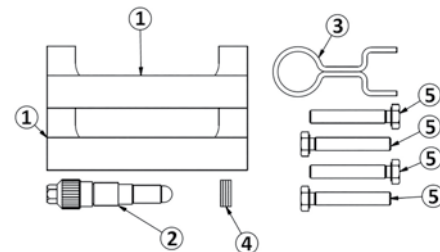

829075

ENGINE TIMING KIT VAG DIESEL V6 TDI - 2.7, 3.0

THIS KIT HAS BEEN SPECIFICALLY DESIGNED AS A KIT TO SUIT THE POPULAR 2.7/3.0 TDI AND TDI CR (COMMON RAIL) CHAIN DRIVEN DIESEL ENGINE FOUND IN THE VAG RANGE

COMPONENTS

REF	ART. NO.	OEM	DESCRIPTION
1	4880056	3242	LOCKING PIN (CHEM. BLACK)
2	4880092	3359	INJECTION PUMP TIMING PIN
3	4880147	T40049	CRANKSHAFT TURNING TOOL (T40049)
4	4880156	T40058	PULLEY BOLT
5	4880148	T40060	CAMSHAFT ALIGNMENT PIN ASSEMBLY (T40060)
6	4880149	T40061	CAMSHAFT ALIGNMENT TOOL - AUDI (T40061)
7	4880150	T40062	TENSIONING TOOL AUDI (T40062)
8	4880151		CHAIN TENSIONER PIN

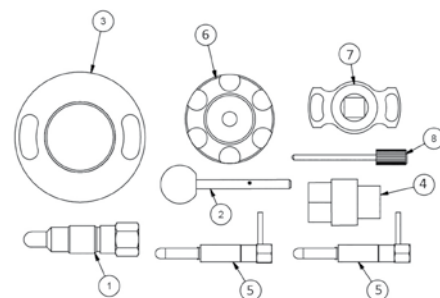

829076

CAMSHAFT SETTING TOOL VAG PETROL 16V FSI (BELT DRIVE) - 1.4, 1.6

A SMALL BUT ESSENTIAL KIT FOR SETTING THE CAMSHAFTS ON THE POPULAR 1.4 AND 1.6 FSI PETROL ENGINES FOUND ACROSS THE VAG RANGES FROM 1996 TO 2008. THESE ENGINES USE ONE BELT TO TRANSFER THE DRIVE FROM THE CRANKSHAFT TO ONE CAMSHAFT THEN A SECOND BELT TO TRANSFER THE DRIVE ACROSS THE CAMSHAFTS. DEPENDING ON THE ENGINE SPECIFICATION THE CAM SETTING PINS MAY BE USED WITH OR WITHOUT THE CROSS BAR PROVIDED.

COMPONENTS

REF	ART. NO.	OEM	DESCRIPTION
1	4880094	T10016/T10074	CAMSHAFT LOCKING TOOL - VAG

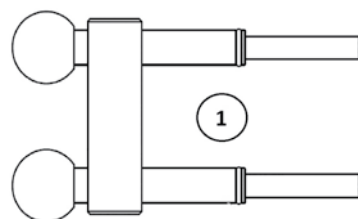

829077

ENGINE TIMING KIT VAG DIESEL PD TDI - 1.2, 1.4, 1.9, 2.0

VAG DIESEL ENGINE TIMING TOOL MASTER KIT OFFERED SPECIFICALLY FOR THE APPLICATIONS LISTED ON OUR WEBSITE. DESIGNED TO ALLOW THE REPLACEMENT OF THE CAMSHAFT DRIVE BELTS FOUND ON THE POPULAR VAG DIESEL ENGINES FROM 1999 TO 2015.

COMPONENTS

REF	ART. NO.	OEM	DESCRIPTION
1	4880250	E10347 04	DIA. 4.0MM TENSIONER PIN
2	4880251	E10347 07	DIA. 7.0 MM TENSIONER PIN
3	4880274	T10115	LOCKING PIN
4	4880092	T20102, 3359	INJECTION PUMP TIMING PIN
5	4880093	T10008	TENSIONING TOOL (ZINC PL. Y)
6	4880140	T10050	CRANKSHAFT LOCKING TOOL
7	4880141	T10100	CRANKSHAFT ALIGNMENT TOOL
8	4880157	T10060	TENSIONER PIN
9	4880195	T40098	TENSIONER PULLEY LOCKING PIN ASSEMBLY [T40098]
10	4880196	T10265	TENSIONER PULLEY LOCKING PIN ASSY Ø2.5. [T10265]
11	4880197	T10264	6 MM BALL END HEX KEY
12	4880252	E10347 08	DIA. 8.0 MM TENSIONER PIN
13	4880017	T10020 / V.159	TENSIONER
14	4880016	T10020 / 2287	TENSION WRENCH

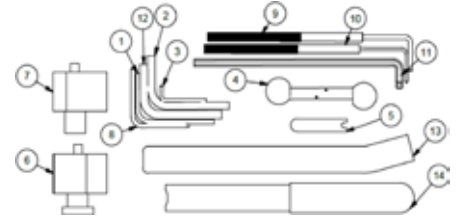

829078

ENGINE TIMING KIT VAG PETROL, DIESEL - 1.7, 1.9 (DIESEL), 1.6, 2.0 (PETROL)

VAG COMBINATION KIT

COMPONENTS

REF	ART. NO.	OEM	DESCRIPTION
1	4880017	T10020	TENSIONER
2	4880015	2587, MATRAV159	TENSION WRENCH
3	4880081	2065A	SETTING BRACKET (ZINC PL.)
4	4880142		M5 X 60 HT SETSCREW S/COL
5	4880158	T10098	CAMSHAFT SETTING BRACKET
6	4880092	T20102, 3359	INJECTION PUMP TIMING PIN
7	4880071	2064	SETTING SPIGOT (CHEM. BLACK) (PIN 15.5 X 67)
8	4880144	T40011	TENSIONER LOCKING PIN 1.4MM BZP & CLEAR PASSIVATE
9	4880143		STUD AND NUT ASSEMBLY
10	4880155	T10092	TENSIONER BOLT
11	4880154	T20018, 3366, T20044	CHAIN TENSIONER RETAINER

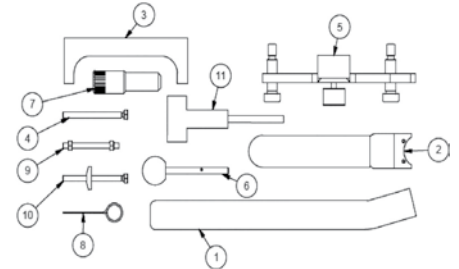

829079

ENGINE TIMING KIT VOLVO DIESEL 5 CYLINDER - 2.0, 2.4

THE 829079 KIT PROVIDES ALL THE ESSENTIAL ENGINE TIMING TOOLS TO SET AND LOCK THE ENGINE COMPONENTS OF THE POPULAR VOLVO 2.0LT AND 2.4LT 5 CYLINDER DIESEL ENGINES TO ALLOW CAMSHAFT BELT REPLACEMENT.

• ADDITIONAL RECOMMENDED TOOLING - SONIC RECOMMENDS THE USE OF SONIC 829089 CRANKSHAFT PULLEY HOLDING TOOL WHEN TIGHTENING OR LOOSENING THE CRANKSHAFT PULLEY FIXING BOLT.

COMPONENTS

REF	ART. NO.	OEM	DESCRIPTION
1	4880272	999-7005	VOLVO CRANKSHAFT TIMING PIN (999-7005)
2	4880271	999-7007	VOLVO CAMSHAFT TIMING PIN (999-7007)
3	4880096	999-7122	LOCKING PIN (8MM DIA. 70 LONG)
4	4880097	999-7169	LOCKING PIN (8MM DIA X 60)
5	4880068	999-7121	TIMING PIN
6	4880106	999-7120	FLYWHEEL LOCK (ZINC PL.)
7	4880061	999-7119	FLYWHEEL LOCKING TOOL-FORD
8		999-7119	TOOTH BLOCK FOR REFERENCE 7
9	4880332		M8 X 20 H.T.SETSCREW
10	4880047		WASHER M8 ZINC PLATED
11	4880197		6 MM BALL END HEX KEY
12	4880090	999-7233	SETTING PIN 5.0MM (5 X 50)

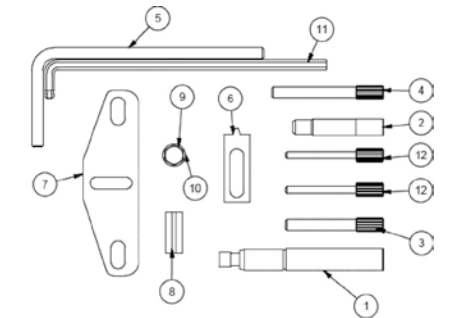

829080

ENGINE TIMING KIT VOLVO PETROL GTDI - 2.0

THE 829080 IS A 6 PIECE ENGINE TIMING KIT DESIGNED FOR THE VOLVO 2.0 DIRECT INJECTION PETROL ENGINES FOUND IN VOLVO VEHICLES FROM 2010. DEVELOPED TO ALLOW THE TIMING CHAIN TO BE REPLACED WHILST LOCKING THE CRANKSHAFT AND CAMSHAFTS IN THEIR CORRECT TIMED POSITIONS. THE 829080 ALSO INCLUDES THE SPECIAL VOLVO TYPE CRANKSHAFT POSITION SENSOR ALIGNMENT TOOL.

COMPONENTS

REF	ART. NO.	OEM	DESCRIPTION
1	4880245	999 7405, 303-1504	FORD GTDI M14 CAMSHAFT ALIGNMENT TOOL ASSY
2	4880290	999 7416	VOLVO 2.0 GTDI CKP SENSOR ALIGNMENT TOOL
3	4880049	999 7406, 303-748	CRANKSHAFT LOCKING PIN - FORD (CHEM. BLACK)
4	4880249		DIA. 3.0MM TENSIONER PIN
5	4880289	999 7415	VOLVO 2.0 GTDI POSITION SETTING TOOL

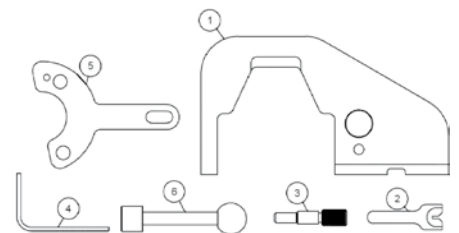

829081

ENGINE TIMING KIT VOLVO DIESEL TDCI (2011 ON) - 1.6

THE 829081 KIT HAS BEEN DEVELOPED SPECIFICALLY FOR THE 1.6 D VOLVO DRIVE/D2 ENGINES. 829081 IS A 3 PIECE KIT CONSISTING OF THE COMPONENTS REQUIRED TO LOCK THE CRANKSHAFT, CRANK PULLEY AND THE CAM PULLEY IN THEIR TIMED POSITION TO ALLOW THE REMOVAL AND REPLACEMENT OF THE CAMSHAFT TIMING BELT. WHILST THE 829081 HAS BEEN SPECIFICALLY PUT TOGETHER TO COVER THE LATEST GENERATION 1.6 DIESEL ENGINES FROM VOLVO, THE KIT INCLUDES COMPONENTS THAT ARE ALSO RELEVANT TO EARLIER FORD ENGINES.

COMPONENTS

REF	ART. NO.	OEM	DESCRIPTION
1	4880064	303-734, 999-7169	FLYWHEEL LOCKING PIN (12 X 55)
2	4880096	303-735, 999-7122	LOCKING PIN (8MM DIA. 70 LONG)
3	4880090	303-732, 999-7121	SETTING PIN 5.0MM (5 X 50)

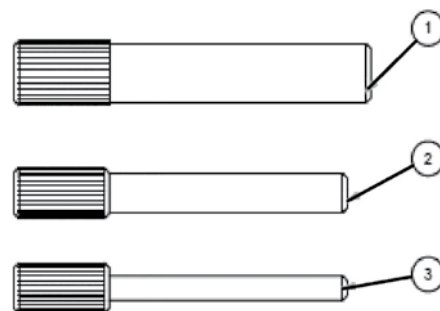

829082

ENGINE TIMING KIT RENAULT, VOLVO PETROL TWIN CAM 16V/20V - 2.0, 2.4

THE 829082 KIT PROVIDES ALL THE ESSENTIAL ENGINE TIMING TOOLS TO SET AND LOCK THE ENGINE COMPONENTS OF THE POPULAR RENAULT/VOLVO 2.0LT AND 2.5LT PETROL ENGINES TO ALLOW CAMSHAFT BELT REPLACEMENT. ALSO OFFERS COVERAGE FOR THE 1.6, 1.8, 1.9 AND 2.3 DERIVATIVES. SEE ATTACHED APPLICATIONS.
* ADDITIONAL RECOMMENDED TOOLING - SONIC RECOMMENDS THE USE OF SONIC 829089 CRANKSHAFT PULLEY HOLDING TOOL WHEN TIGHTENING OR LOOSENING THE CRANKSHAFT PULLEY FIXING BOLT.

COMPONENTS

REF	ART. NO.	OEM	DESCRIPTION
1	4880101	MOT 1340, 999 5451	TIMING PIN
2	4880105	MOT 1348	TENSIONING TOOL (NO SLEEVE)
3	4880107	MOT 1337, 999 5452	CAMSHAFT SETTING TOOL
4	4880051	303-507, 999 7152	MAZDA SCREW
5	4880050	303-376B	CAMSHAFT ALIGNMENT STRAP (CHEM. BLACK)
6			HEX-HEAD BOLT FOR 3

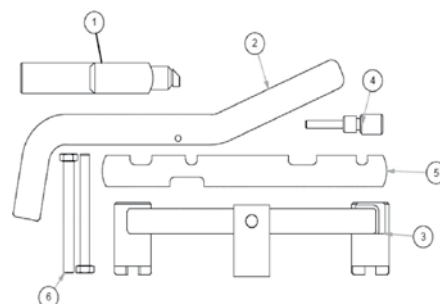

829083

ENGINE TIMING KIT CHRYSLER/LDV DIESEL CRD - 2.5, 2.8

THE 829083 KIT WAS DEVELOPED FOR THE CHRYSLER DOHC COMMON RAIL DIESEL ENGINE FOUND IN THE VOYAGER, GRAND VOYAGER AND THE LDV MAXUS VAN. THE 829083 KIT ALLOWS THE USER TO REPLACE THE TIMING BELT WHILST MAINTAINING THE CORRECT TIMED POSITION OF THE CAMSHAFTS AND CRANKSHAFT.

COMPONENTS

REF	ART. NO.	OEM	DESCRIPTION
1	4880222	VM.1089, LDV196	CHRYSLER 2.5/2.8 CRD TIMING PIN - VM 1089
2	4880223	VM.1068, LDV196	TIMING PIN (CHRYSLER 2.5/2.8 CRD VM.1068)
3	4880224	VM.1052, LDV192	TIMING PIN (CHRYSLER 2.5/2.8 CRD VM.1052)
4	4880225	VM.1053, LDV193	TIMING PIN (CHRYSLER 2.5/2.8 CRD VM.1053)
5	4880226	VM1074	TIMING BELT RETAINING SPRING (VM.1074)
6	4880015	VM.9660, H2587	TENSION WRENCH
7	4880282	VM.1080	CHRYSLER TIMING PIN (VM.1080)
8	4880283	VM.8873	CHRYSLER TIMING PIN (VM.8873)

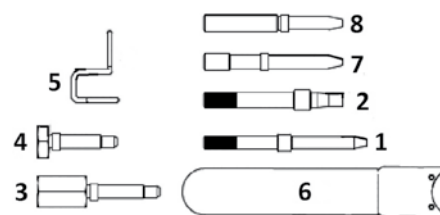

829084

ENGINE TIMING KIT CHRYSLER/JEEP DIESEL CRD - 2.8

THE 829084 KIT HAS BEEN DEVELOPED SPECIFICALLY FOR THE 2008 AND LATER 2.8 CRD CHRYSLER/JEEP ENGINES WHERE THE CAM BELT DRIVES ONE CAMSHAFT AND THE SECOND CAMSHAFT IS DRIVEN VIA GEARS. THE 829084 KIT IS A 2 PIECE KIT CONSISTING OF THE COMPONENTS REQUIRED TO LOCK THE CRANKSHAFT AND CAMSHAFTS IN THEIR TIMED POSITION TO ALLOW THE REMOVAL AND REPLACEMENT OF THE CAM BELT AND ASSOCIATED COMPONENTS.

COMPONENTS

REF	ART. NO.	OEM	DESCRIPTION
1	4880284	VM.9992	CHRYSLER CRANKSHAFT LOCKING TOOL (VM.9992)
2	4880285	VM.9991	CHRYSLER EXHAUST CAMSHAFT LOCKING TOOL (VM.9991)

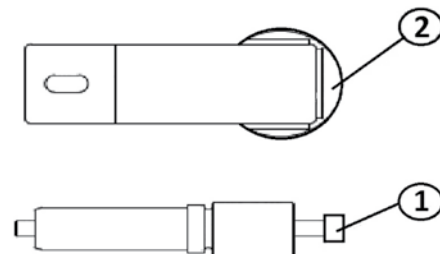

829085

ENGINE TIMING KIT CHRYSLER/JEEP DIESEL CRD - 3.0

THE 829085 KIT HAS BEEN DESIGNED FOR THE JEEP 3.0 LT V6 DIESEL ENGINE FOUND IN THE LATE MODEL (2011 ON) JEEP GRAND CHEROKEE. THE 829085 PROVIDES ALL THE CAM AND CRANKSHAFT LOCKING TOOLS REQUIRED FOR CHAIN REPLACEMENT.

COMPONENTS

REF	ART. NO.	OEM	DESCRIPTION
1	4880311	VM10338-1	CAMSHAFT LOCKING TOOL RH - ASSY
2	4880310	VM10338-2	CAMSHAFT LOCKING TOOL LH - ASSY
3			CAP HEAD SCREWS FOR REFERENCE 1
4	4880313	VM10359A	CRANKSHAFT TIMING PIN ASSY
5	4880312	VM10339	TENSIONER LOCKING PIN

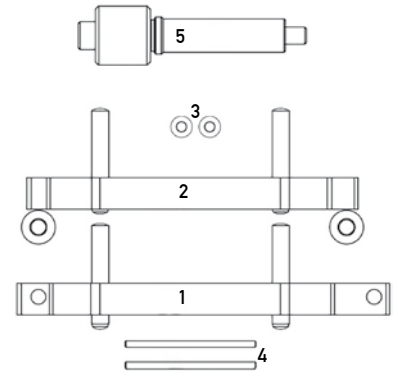

829086

ENGINE TIMING KIT MERCEDES/CHRYSLER CRD - 2.2, 2.7

THE 829086 COVERS A LARGE RANGE OF VEHICLES FITTED WITH CHAIN DRIVEN ENGINES FROM MERCEDES BENZ INCLUDING THE PT CRUISER 2.2 CRD AND JEEP GRAND CHEROKEE 2.7 CRD FROM CHRYSLER.

COMPONENTS

REF	ART. NO.	OEM	DESCRIPTION
1	4880203	602 589 00 40 00 8929	FLYWHEEL LOCKING TOOL
2	4880206	602 589 00 40 00 8929	CAMSHAFT LOCKING PIN ASSY
3	4880205	601 589 02 40 00 8933	FLYWHEEL LOCKING TOOL MB 602 589 00 40 00
4			BOLTS FOR REFERENCE 3

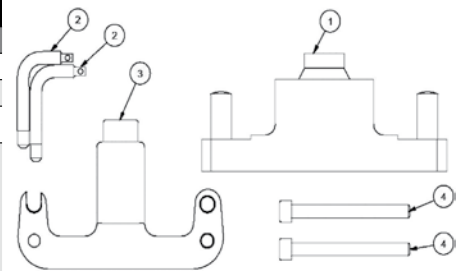

829087

ENGINE/BALANCE SHAFT TIMING KIT MERCEDES DIESEL (651) - 1.8, 2.1

THE 829087 HAS BEEN SPECIFICALLY DESIGNED FOR MERCEDES VEHICLES FITTED WITH THE CHAIN DRIVEN 1.8/2.1 CDI DIESEL ENGINES (ENGINE CODE PRE FIX 651). THESE ENGINES ARE FOUND ACROSS THE MERCEDES RANGE INCLUDING A, B, C, E, G AND S CLASS AS WELL AS THE SPRINTER AND VITO VANS FROM AS EARLY AS 2007 UP TO 2015. THESE ENGINES ARE ALSO FOUND IN THE JEEP AND DODGE RANGES. THE 829087 CONTAINS THE ESSENTIAL ALIGNMENT TOOLS TO ALIGN THE CAMSHAFTS, CRANKSHAFT AND BALANCE SHAFTS IN ONE COMPACT KIT.

COMPONENTS

REF	ART. NO.	OEM	DESCRIPTION
1	4880316	651 589 01 40 00	CAMSHAFT ALIGNMENT TOOL
2	4880315	651 589 00 40 00	CRANKSHAFT HOLDING/TURNING TOOL
3/4/5/6	4880314	651 589 02 63 00	BALANCE SHAFT LOCK TOOL ASSY

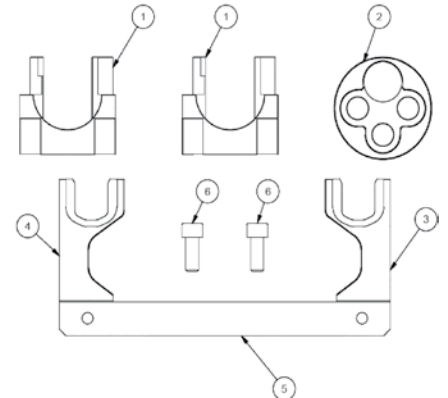

829088

CAMSHAFT HOLDING TOOL FIAT/FORD/OPEL DIESEL JTD - 1.3

THE 829088 CAMSHAFT PULLEY HOLDING TOOL HAS BEEN DESIGNED TO ALLOW THE USER TO LOOSEN AND TIGHTEN THE CAMSHAFT PULLEY FIXINGS WITHOUT MOVING THE CAMSHAFTS OR CAUSING DAMAGE TO ANY TIMING TOOLS THAT MAY BE FITTED. CONVENIENTLY DESIGNED TO ALLOW THE USE OF A 1/2 DRIVE WRENCH THE 829088 COMBINES THE DOUBLE HEADED OEM TOOL INTO ONE SINGLE TOOL.

COMPONENTS

REF	ART. NO.	OEM	DESCRIPTION
1	829088	1 871 008 600 303-1475	CAMSHAFT HOLDING TOOL FIAT/FORD/OPEL DIESEL JTD - 1,3

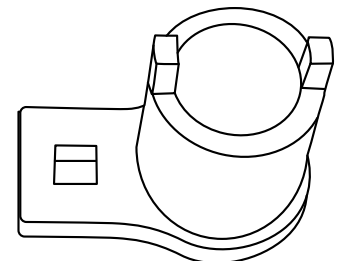

829089

CAMSHAFT SETTING TOOL VOLVO/FORD

THE 829089 IS DESIGNED TO HOLD THE FRONT CRANKSHAFT PULLEY WHILE TIGHTENING OR LOOSENING THE PULLEY FIXINGS ACROSS THE VOLVO RANGE OF ENGINES AND THE FORD 2.5 PETROL ENGINE FOUND IN THE ST FOCUS ETC.

COMPONENTS

REF	ART. NO.	OEM	DESCRIPTION
1	829089	999 5433, 303-1179	CRANKSHAFT HOLDING TOOL VOLVO/FORD



829090

CAMBELT TENSIONER WRENCH VAG 30MM PETROL - 1.0, 1.2, 1.4

A 12 POINT (DOUBLE HEX) 30 MM CAM BELT TENSIONER WRENCH INTENDED FOR USE ON VAG VEHICLES AS LISTED ON OUR WEBSITE. THE 829090 VAG TENSION WRENCH IS DESIGNED TO ALLOW THE USER TO ADJUST THE CAMSHAFT DRIVE BELT TENSIONER IN THE MANNER DESCRIBED BY THE MANUFACTURER. THE 829090 IS SPECIFICALLY DESIGNED FOR USE ON THE LATEST RANGE OF 1.0LT, 1.2LT AND 1.4LT BELT DRIVEN PETROL TURBO CHARGED PETROL ENGINES.

EQUIVALENT TO OEM T10499

COMPONENTS

REF	ART. NO.	OEM	DESCRIPTION
1	829090	T10499	CAM BELT TENSIONER WRENCH VAG 30MM PETROL - 1,0/1,2/1,4

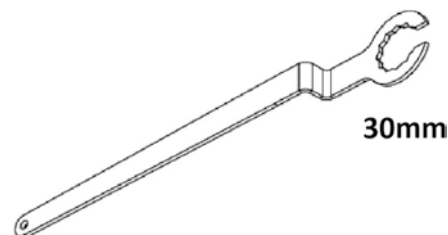

829091

CRANKSHAFT HOLDING TOOL OPEL 2.0, 2.2

THE 829091 IS DESIGNED TO HOLD THE FRONT CRANKSHAFT PULLEY WHILE TIGHTENING OR LOOSENING THE PULLEY FIXINGS ON THE GM/OPEL/SAAB 2,0LT AND 2,2 LT PETROL ENGINES.

COMPONENTS

REF	ART. NO.	OEM	DESCRIPTION
1	4880230	KM-J-38122-A	HOLDING TOOL (KM-J-38122-A)

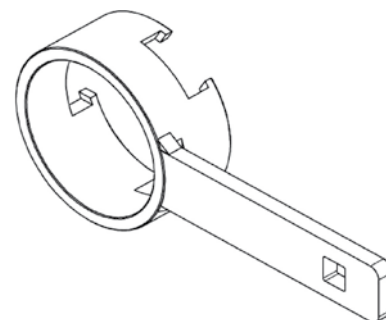

829092

AUXILIARY DRIVE BELT WRENCH PETROL TFSI 16MM VAG - 1.4

A 16.0 MM ACROSS FLATS SPANNER WITH PVC HANDLE INTENDED FOR USE ON VAG VEHICLES (PREDOMINANTLY VOLKSWAGEN) UTILISING THE 1.4 TSI ENGINES. THE CRANKED SPANNER IS REQUIRED FOR RELEASING TENSION ON THE AUXILIARY DRIVE BELT, WHICH IS ACHIEVED BY ROTATING THE ENGINES' SPRING LOADED BELT TENSIONER AWAY FROM THE BELT.

EQUIVALENT TO OEM T10447

COMPONENTS

REF	ART. NO.	OEM	DESCRIPTION
1	829092	T10447	AUXILIARY DRIVE BELT WRENCH PETROL TFSI 16MM VAG - 1,4

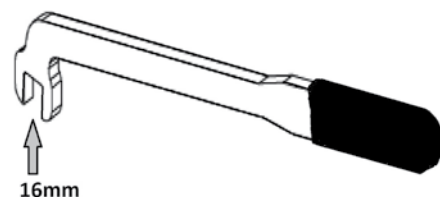

829093

TIMING CHAIN TENSIONER LEVER VAG PETROL TFSI - 1.8/2.0

THE 829093 IS A SPECIALLY DESIGNED TENSIONER LEVER FOR LATER GENERATION III 1.8 & 2.0 4V TFSI ENGINES. THIS ONE PIECE LEVER ALLOWS THE USER TO PUSH BACK THE TIMING CHAIN TENSIONER WITHOUT REMOVING THE FRONT ENGINE COVER. THE 829093 IS THE SONIC EQUIVALENT TO THE VAG ORIGINAL EQUIPMENT NUMBER T40243.

COMPONENTS

REF	ART. NO.	OEM	DESCRIPTION
1	829093	T40243	TIMING CHAIN TENSIONER LEVER VAG PETROL TFSI - 1,8/2,0

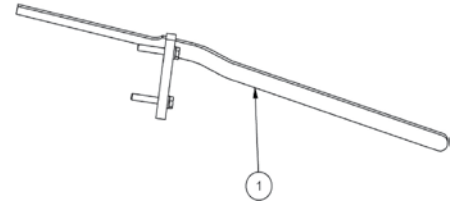

829094

TIMING CHAIN TENSIONER LEVER FORD PETROL, DIESEL

THE 829094 FLYWHEEL LOCKING KIT IS EQUIVALENT TO THE FORD OEM FLYWHEEL LOCKING KIT AS DETAILED BELOW. IT IS USED TO LOCK THE FLYWHEEL TO ALLOW FRONT PULLEYS ETC. TO BE LOOSENED AND TIGHTENED WITHOUT TURNING THE ENGINE. N.B: STARTER MOTOR MUST FIRST BE REMOVED.

COMPONENTS

REF	ART. NO.	OEM	DESCRIPTION
1	4880061	21-168 A, 303-393A	FLYWHEEL LOCKING TOOL-FORD
2	4880062	303-393-02	TOOTH BLOCK ITEM 2
3	4880063	303-393-01	SHORT TOOTH BLOCK

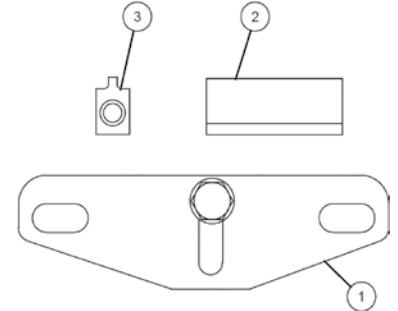

829095

HIGH PRESSURE FUEL PUMP PULLER DIESEL FORD - TDCI - TRANSIT 2.2

AS OF 2011 FORD CHANGED THE METHOD OF FUEL PUMP SPROCKET REMOVAL ON THE 2.2 TDCI (PUMA) DIESEL ENGINES. THE SPROCKET NO LONGER HAS THREADED HOLES WHICH MEANS THE LEGS OF THE PULLER USED TO REMOVE THE SPROCKET MUST BE HOOKED IN SHAPE. THE K00286 PULLER ALLOWS THE REMOVAL OF THESE SPROCKETS BY ALLOWING THE HIGH PRESSURE DIESEL INJECTION PUMP TO BE PUSHED OUT OF THE PUMP SPROCKET TO ENABLE PUMP REMOVAL WITHOUT DISTURBING THE TIMING CHAIN. SPECIAL NOTE: TO PERFORM THIS TASK THE 829095 MUST BE USED WITH FORD SPECIAL TOOL 303-1151 (SPROCKET HOLDING TOOL).

NOTE: THE 829095 KIT CONTAINS A FORCE SCREW. FORCE SCREWS MUST BE LUBRICATED WITH HIGH PRESSURE GREASE. SONIC RECOMMENDS THE USE OF MOLYBDENUM DISULPHIDE GREASE (DRIVE SHAFT GREASE) DO NOT USE ASSEMBLY OR ANTI-SEIZE GREASES (COPPER GREASES).

EQUIVALENT TO OEM 303-249, 303-249-01

COMPONENTS

REF	ART. NO.	OEM	DESCRIPTION
1	4880240	303-249-01	FUEL PUMP REMOVER LEG ASSEMBLY
2	4880241	303-249-01	CENTER LOCATION PLUG FOR DIESEL PUMP REMOVER
3	4880013	303-249	PULLER BEAM
4	4880014	303-249-01	PULLER CENTRE SCREW
5	4880219	303-249	M8 X 50 CAP HEAD
6	4880047	999 5382	WASHER M8 ZINC PLATED

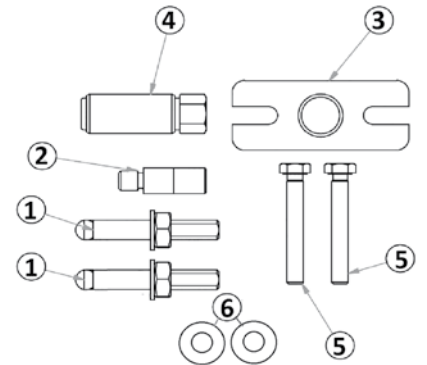

829096

DIESEL INJECTION PUMP TIMING KIT BOSCH/NIKKI/NIPPON DENSO/LUCAS CAV

THE 829096 TOOL KIT IS REQUIRED WHEN SETTING UP BOSCH EP/VE ROTARY, NIKKI, NIPPON DENSO, CAV ROTO-DIESEL INJECTION PUMPS (TOP ENTRY PORT) AND THE PSA XUD RANGE OF ENGINES.

COMPONENTS

REF	ART. NO.	OEM	DESCRIPTION
1	4880083		ADAPTOR ASSY ZINC
2	4880084		DTI EXTENSION ITEM 3
3	4880085		CONNECTOR (CHEM. BLACK)
4	4880086		M14 ADAPTOR ASSEMBLY
5	4880087		PLUNGER
6	4880088	999 5382	PROBE ASSEMBLY
7	4880089	999 5382	DTI/CAV MOUNTING BRACKET
8	4880124		ADAPTOR M8 SHORT ASSY.
9	4880125		DTI EXTENSION ITEM 2
10	4880126		ADAPTOR M10 SHORT
11	4880123	KM 571A, 3313	DTI -ORD.STYLE C/W TEST CERT.

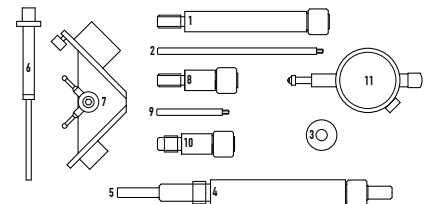

829097

BALANCE SHAFT SETTING KIT BMW DIESEL N47 - 2.0

829097 HAS BEEN DESIGNED TO SET THE BALANCE SHAFTS ON BMW N47 DIESEL ENGINES WHEN THE BALANCE SHAFTS HAVE BEEN DISTURBED ALSO INCLUDES THE CRANKSHAFT SETTING BRIDGE REQUIRED TO SET THE CRANKSHAFT IN ITS BOTTOM DEAD CENTRE (BDC) NUMBER 1 POSITION.(SEE APPLICATION LIST).

COMPONENTS

REF	ART. NO.	OEM	DESCRIPTION
A	4880291	11 8 750	BMW BALANCER SHAFT LOCATING TOOL
B	4880292	11 8 790, 11 8 791, 11 8 793	BMW CRANKSHAFT LOCATOR TOOL

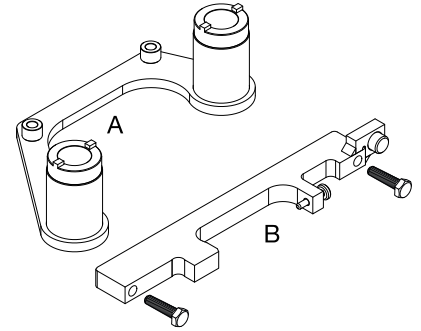

829098

SPROCKET HOLDING TOOL UNIVERSAL

THE 829098 IS A SPROCKET HOLDING WRENCH USED TO TIGHTEN AND LOOSEN CAMSHAFT SPROCKETS AGAINST TO PREVENT DAMAGE TO TIMING PINS AND CAMSHAFTS.

COMPONENTS

REF	ART. NO.	OEM	DESCRIPTION
1	829098	6016T, 1 860 831 000, 1 860 885 000, 1 842 128 000, 15-030A, MOT 799, MP1-216, 3036, 5199, 1 822 146 000, 1 822 155 000, 205-072, U20002, 999 5645, 999-5199, 999-5705, 15-30-A, 15-030-A, MP 1-216, 999 5199, 999-5645, 999 5705, 9880, MB990767, UN205 072, 0132-AA	SPROCKET HOLDING TOOL - UNIVERSAL

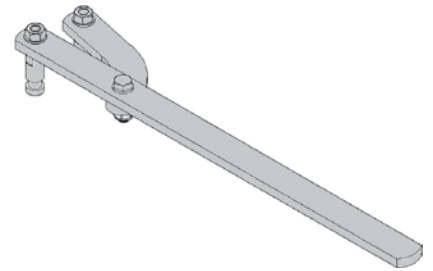

829099

CAM BELT TENSIONER WRENCH VAG, VOLVO 32MM DIESELS TDI - 2.5

THE 829099 IS A 32MM MULTI HEX WRENCH DESIGNED TO FIT THE TENSIONER USED ON THE VAG 2.5 TDI/SDI DIESEL ENGINES. EQUIVALENT TO OEM NUMBER 3355.

COMPONENTS

REF	ART. NO.	OEM	DESCRIPTION
A	4880146	3355, 999 5649 , 999-5649	32MM. HEX WRENCH TENSIONER PULLEY



829100

CAM BELT TENSIONER WRENCH VAG ADJUSTABLE HEAD

THE 829100 IS AN ADJUSTABLE CAM-BELT TENSIONER TOOL. EQUIVALENT TO EOM T10020 AND MATRA V159.

COMPONENTS

REF	ART. NO.	OEM	DESCRIPTION
1	829100	T10020//MATRA V159	CAM BELT TENSIONER WRENCH VAG ADJUSTABLE HEAD



829101

BALANCE SHAFT SETTING KIT BMW

BMW - N40, N42, N43, N45, N46, N49, N52
829101 HAS BEEN SPECIFICALLY DESIGNED TO SET THE BALANCE SHAFTS ON BMW ENGINES WHEN THE BALANCE SHAFTS HAVE BEEN DISTURBED.
EQUIVALENT TO OEM 11 7 700, 11 5 140, 11 9 280, 11 9 330

COMPONENTS

REF	ART. NO.	OEM	DESCRIPTION
1	4880286	11 8 700	BMW BALANCER SHAFT LOCKING TOOL (119 330)
2	4880287	11 5 140	BMW BALANCER SHAFT HOLDING TOOL (115 140)
3	4880288	11 9 280	BMW CRANKSHAFT HOLDING TOOL
4	4880258	11 9 330	BALANCER SHAFT ALIGNMENT TOOL (N43)

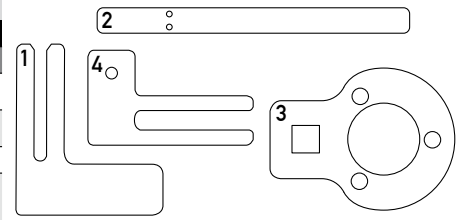

829102

CRANKSHAFT HOLDING TOOL BMW DIESEL N47/57 - 1.6/2.0/3.0

829102 IS A CRANKSHAFT LOCKING AND HOLDING TOOL IS DESIGNED TO LOCK THE CRANKSHAFT ON THE N47 (2.0L) AND N57 (3.0L) DIESEL ENGINES FROM 2007 FOUND IN THE BMW RANGE. IT IS SPECIFICALLY REQUIRED WHEN REPLACING OR REPAIRING THE SECONDARY DRIVE CHAINS ON THE ENGINES LISTED. ADDITIONAL CAMSHAFT OR BALANCE SHAFT TOOLING MAY BE REQUIRED
EQUIVALENT TO OEM 11 4 320.

COMPONENTS

REF	ART. NO.	OEM	DESCRIPTION
1	4880301	11 4 320	MACHINING DETAIL FOR BMW N47 & N57 CRANKSHAFT LOCKING TOOL
2	4880302		PIN FOR BMW N47 & N57 CRANKSHAFT LOCKING TOOL (11 4 320)
3	4880110		M5 X 10MM COUNTERSUNK SOCKET BLACK
4	4880169		M6X16 HT SETSCREW-S/COL
5	4880010		WASHERS M6 FORM C ZC.PL.
6	4880328		M6 FULLNUT

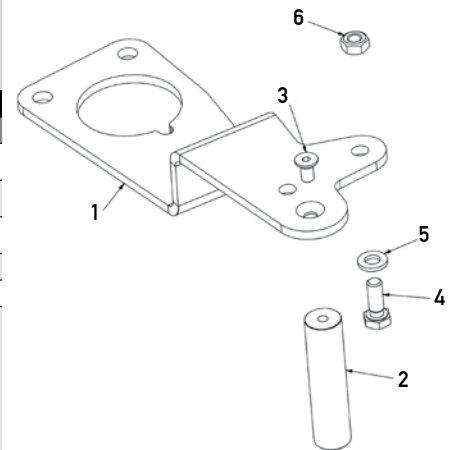

829103

FRONT PANEL GUIDE SET VW T5 VAN

829103 ALLOWS THE USER TO SPACE THE FRONT OF THE T5 VAN OFF AWAY FROM THE FRONT OF THE VEHICLE WITHOUT DISCONNECTING ALL THE FRONT PANEL PIPE WORK SAVING SIGNIFICANT TIME AND ENSURING THE PANEL DOES NOT FALL SO PREVENTING DAMAGE. SCREW IN PLACE OF MAIN FRONT PANEL MOUNTING PINS.
SUPPLIED AS A SET OF 4.

COMPONENTS

REF	ART. NO.	OEM	DESCRIPTION
A	4880306	T10288	VW (2004 - ONWARDS) T5 FRONT BODY PANEL GUIDE PIN ASSY



829104

AUXILIARY DRIVE BELT WRENCH SET PETROL BMW MINI - 1.6

THIS TOOL SET SIMPLIFIES THE REMOVAL AND REPLACEMENT OF THE SERPENTINE BELT WHEN SERVICING OR REPAIRING THE W10, W11 1600CC ENGINES AS USED IN THE MINI ONE, COOPER & COOPER S (PRE. 2007 MK1), MINI CONVERTIBLE (PRE 2009 MK1).

COMPONENTS

REF	ART. NO.	OEM	DESCRIPTION
1	4880138	11 8 410	BELT TENSIONER ASSEMBLY
2	4880139	11 8 390	BMW MINI CAMSHAFT PULLEY WRENCH (11 8 390)
3	4880002, 4880003	11 8 470 & 11 8 280	Ø4MM TENSIONER PIN + Ø4.5MM TENSIONER PIN

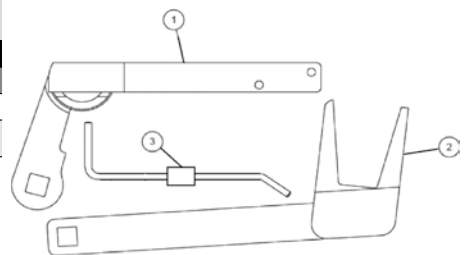

829105

FRONT PULLEY HOLDING TOOL BMW N47/N57 DIESEL ENGINE 1.6/2.0/3.0

829105 IS A SPECIAL CRANKSHAFT PULLEY HOLDING TOOL FOR THE N47/N57 BMW DIESEL ENGINES FOUND ACROSS THE BMW AND MINI RANGES. DESIGNED TO HOLD THE CRANKSHAFT PULLEY STATIONARY WHILE LOOSENING OR TIGHTENING THE CENTRE BOLTS OF THE PULLEY. EQUIVALENT TO OEM 11 7 220

COMPONENTS

REF	ART. NO.	OEM	DESCRIPTION
1	4880221	11 7 220	BRACE WELDED ASSY
2	4880220		THREADED BOSS
3	4880333		M16 FLAT WASHER FORM A TO DIN 125A
4	4880327		LOCK NUT M16 X 1.5 24MM A/F 8MM THK CHEMI BLACK
5	4880213		M10 X 100 SKT HD CAP SCREW
6	4880217		M8 X 100MM CAP HEAD

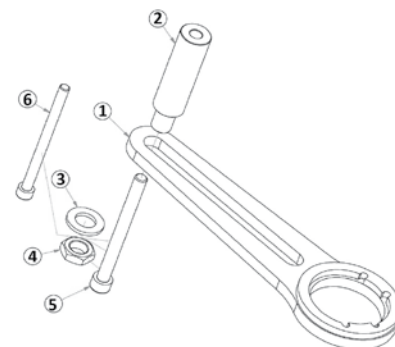

829106

CAMSHAFT TIMING TOOL FORD PETROL ECOBOOST - 1.6

THE 829106 CAMSHAFT LOCKING PLATE IS REQUIRED WHEN SETTING THE CAMSHAFT TO CAM SPROCKET TIMING ON FORD 1.6 ECO BOOST PETROL (SIGMA) ENGINES.

COMPONENTS

REF	ART. NO.	OEM	DESCRIPTION
A	829106	303-1552	CAMSHAFT TIMING TOOL FORD PETROL ECOBOOST - 1.6



A

NOTE: THE USE OF 829106 REQUIRES THE USE OF ADDITIONAL ENGINE LOCKING AND TIMING TOOLS NOT SUPPLIED IN THIS KIT.



829107

OIL PUMP ALIGNMENT PLATE FORD, JAGUAR, LAND ROVER, ROVER, PSA DURATORQ DIESEL 2.0, 2.2, 2.4, 3.2

THE 829107 OIL PUMP ALIGNMENT TOOL HAS BEEN DEVELOPED TO ALLOW THE USER TO CORRECTLY ALIGN THE ENGINE OIL PUMP IN THE SUMP AFTER AN ENGINE REBUILD ETC. IT IS IMPORTANT THAT THE PUMP BE CORRECTLY AND ACCURATELY ALIGNED TO ENSURE THE OIL PUMP SPROCKET IS NOT OPERATING WITH EXCESSIVE SIDE LOADS.

COMPONENTS

REF	ART. NO.	OEM	DESCRIPTION
A	829107	303-705, 303-1093, 0198.H	OIL PUMP ALIGNMENT PLATE FORD/JAGUAR LAND ROVER/PSA DIESEL



A

NOTE: THE USE OF 829106 REQUIRES THE USE OF ADDITIONAL ENGINE LOCKING AND TIMING TOOLS NOT SUPPLIED IN THIS KIT.



829108

CAM BELT TENSIONER TOOL SET VAG TDI - 1.9, 2.0

THE 829108 USED DURING TIMING BELT REPLACEMENT ON VOLKSWAGEN 1.9/2.0 TDI PD SOHC, 4 CYLINDER DIESEL ENGINES WHERE THERE IS RESTRICTED ACCESS TO THE TENSIONER PULLEY ROLLERS DUE TO THE MODIFIED SUB-FRAME MOUNTINGS.

COMPONENTS

REF	ART. NO.	OEM	DESCRIPTION
1	4880197	T10264	6 MM BALL END HEX KEY
2	4880196	T10265	TENSIONER PULLEY LOCKING PIN ASSY 02.5. [T10265]
3	4880195	T40098	TENSIONER PULLEY LOCKING PIN ASSEMBLY [T40098]



829109

WATER PUMP PULLER KIT VAG DIESEL - 2.5

THE 829109 WATER PUMP PULLER TOOL SET IS EQUIVALENT TO THE OEM TOOLS REQUIRED TO REMOVE THE WATER PUMP AND WATER PUMP PULLEY ON THE VAG 2.5 DIESEL ENGINES FOUND IN THE VW T5 VAN AND TQAREG VEHICLES.

COMPONENTS

REF	ART. NO.	OEM	DESCRIPTION
1	4880164	T10225	SPECIAL WRENCH VAG
2	4880163	T10221A	PULLER VAG T10221
3	4880166	T10222A	WATER PUMP TOOL

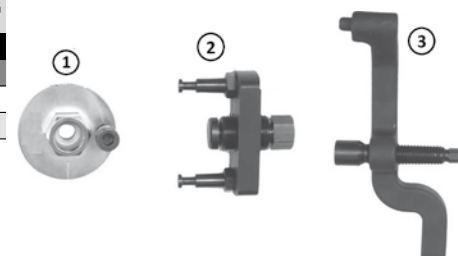



TARGET COMPETITION ITALY

Display tools

737512

WALLDISPLAY 3 MTR. WITH 375 ITEMS

ART. NO.	PCS	DESCRIPTION LOOSE ITEMS
1310...3	4	SCREWDRIVER PH.0, PH.1, PH.2, PH.3
13303...08	6	SCREWDRIVER, SLOTTED 3, 3.5, 4, 5.5, 6.5, 8MM
13610...30	6	SCREWDRIVER, TX T10, T15, T20, T25, T27, T30
47537	1	FLEXIBLE SOCKET SCREWDRIVER, HEX 7MM
14423008...10	2	SOCKET SCREWDRIVER, HEX T HANDLE 8, 10MM
1950203...04	2	T-HANDLE BALL ENDED HEXAGON KEY WRENCH, EXTRA LONG 3, 4MM
47901	1	DOOR UPHOLSTERY PANEL REMOVER SMALL 100MML
47902	1	DOOR UPHOLSTERY PANEL REMOVER 110MML
47903	1	SCRAPER
47904	1	COTTER PIN PULLER
21555...13	7	FLANK SOCKET 1/4", 6 PT. 5.5, 6, 7, 8, 10, 12, 13MM
2155006...13	5	FLANK DEEP SOCKET 1/4", 6 PT. 6, 7, 8, 10, 13MM
22507...19	12	FLANK SOCKET 3/8" 6 PT. 7, 8, 10, 11, 12, 13, 14, 15, 16, 17, 18, 19MM
2256308...19	11	FLANK SOCKET 3/8" 6 PT. DEEP 8, 10, 11, 12, 13, 14, 15, 16, 17, 18, 19MM
22608...18	7	SOCKET 3/8", TX E8, E10, E11, E12, E14, E16, E18
23510...32	18	FLANK SOCKET 1/2", 6 PT. 10, 11, 12, 13, 14, 15, 16, 17, 18, 19, 20, 21, 22, 24, 27, 28, 30, 32MM
2357710...30	13	FLANK SOCKET 1/2", 6 PT. DEEP 10, 12, 13, 14, 15, 16, 17, 18, 19, 21, 22, 24, 30MM
3310115...22	5	WHEEL SOCKET 1/2", 6PT. 15, 17, 19, 21, 22MM

ART. NO.	PCS	DESCRIPTION LOOSE ITEMS
3358513...32	9	IMPACT SOCKET 1/2", 6PT. DEEP 13, 17, 19, 21, 22, 24, 27, 30, 32MM
3397824...35	4	IMPACT DEEP SOCKET 1/2", 12PT. 24, 27, 34, 35MM
4110810...1214	3	FLARE NUT WRENCH 8X10, 11X13, 12X14MM
4120607...1617	6	HINGED SOCKET WRENCH 6X7, 8X9, 10X11, 12X13, 14X15, 16X17MM
41506...32	21	COMBINATION WRENCH 6, 7, 8, 9, 10, 11, 12, 13, 14, 15, 16, 17, 18, 19, 20, 21, 22, 24, 27, 30, 32MM
4170208...19	10	REVERSIBLE RATCHETING WRENCH 12PT. 8, 10, 11, 12, 13, 14, 15, 16, 17, 19MM
4311175	1	COMBINATION PLIERS 7"
4321200	1	LONG NOSE PLIERS 8"
4331200	1	BENT LONG NOSE PLIERS 8"
4341175	1	DIAGONAL PLIERS 7"
4342200	1	LEVERAGE DIAGONAL PLIERS 8"
4351180	1	WATERPUMP PLIERS 7"
4351250	1	WATERPUMP PLIERS 10"
4380250	1	LOCKING PLIERS 10"
42301250	1	ADJUSTABLE WRENCH 10"
42302300	1	ADJUSTABLE WRENCH 12"
43611	1	SNAP RING PLIERS (STRAIGHT-OPEN)
43612	1	SNAP RING PLIERS (STRAIGHT-CLOSE)

ART. NO.	PCS	DESCRIPTION LOOSE ITEMS
43613	1	SNAP RING PLIERS (BENT-OPEN)
43614	1	SNAP RING PLIERS (BENT-CLOSE)
4450250...300	2	OIL FILTER PLIERS 10", 12"
4471250	1	WIRE STRIPPER 10"
4410265	1	RIVETING PLIER 10.5"
4472100	1	FLEXIBLE CABLE HOSE CLAMP REMOVING PLIERS
4533150	1	GRIP PIN PUNCH 150MML 3MM
4534180	1	GRIP PIN PUNCH 180MML 4MM
4536210	1	GRIP PIN PUNCH 210MML 6MM
45118190	1	GRIP CHISEL 190MML 18MM
45124220	1	GRIP CHISEL 220MML 24MM
48212380	1	PRY BAR 380 MM
4611400	1	MACHINIST HAMMER 400GR. FIBRE HANDLE TPR COVER
4620400	1	SAND FILLED HAMMER 400GR.
4631000	1	STONING HAMMER 1000 GR FIBRE HANDLE TPR COVER
46601	1	SUPER HEAVY DUTY HACKSAW
46602	1	MINI HACKSAW
46806	1	UTILITY KNIFE INCLUDING 10 BLADES
46807	1	UTILITY KNIFE INCLUDING 13 BLADES
46911	1	FLAT FILE 8"
46912	1	HALF ROUND FILE 8"
46913	1	ROUND FILE 8"
46914	1	TRIANGULAR FILE 8"
47002	1	FEELER GAUGE 26-PCS
47013	1	MEASURING TAPE 5 METER
7120701	1	RATCHET HANDLE 1/4" 72 TEETH
7120901	1	RATCHET HANDLE 1/4" 45 TEETH
7110101	1	FLEXIBLE RATCHET 1/4" 45 TEETH
7110301	1	DISC RATCHET 1/4" 72 TEETH
71511	1	UNIVERSAL JOINT 1/4"
7141050...150	3	EXTENSION 1/4" 50, 100, 150MML
8113701...3	3	BIT SOCKET PH 1/4", PH.1, PH.2, PH.3
8143703...10	6	BIT SOCKET HEX 1/4", 3, 4, 5, 6, 7, 10MM
8163710...40	7	BIT SOCKET TX 1/4", T10, T15, T20, T25, T27, T30, T40
8173720...30	4	BIT SOCKET TX TAMPERPROOF 1/4", T20H, T25H, T27H, T30H
7120902	1	RATCHET HANDLE 3/8" 45 TEETH
7110102	1	FLEXIBLE RATCHET 3/8" 45 TEETH
7110302	1	DISC RATCHET 3/8" 72 TEETH
7120302	1	EXTENDABLE RATCHET 3/8" 72 TEETH
73220550	1	TORQUES WRENCH 3/8" 5-50NM
71521	1	UNIVERSAL JOINT 3/8"
7142044...250	4	EXTENSION 3/8" 44, 75, 150, 250MML
7172216...21	3	SPARK PLUG 3/8" CLIP SOCKET 16, 18, 21MM
7174214	1	SPARK PLUG SOCKET 12-PT. 3/8" 14MM (90MML)
7175214	1	SPARK PLUG SOCKET 12-PT. 3/8" 14MM (250MML)
8244804...12	8	BIT SOCKET HEX 3/8", 4, 5, 5.5, 6, 7, 8, 9, 10, 12MM
8264815...55	9	BIT SOCKET TX 3/8", T15, T20, T25, T27, T30, T40, T45, T50, T55
8274820...50	7	BIT SOCKET TX TAMPERPROOF 3/8", T20H, T25H, T27H, T30H, T40H, T45H, T50H
8284806...12	5	BIT SOCKET SPLINE 3/8", M6, M8, M9, M10, M12
7120903	1	RATCHET HANDLE 1/2" -45 TEETH
732320200	1	TORQUES WRENCH 1/2" 20-200NM
732360300	1	TORQUES WRENCH 1/2" 60-300NM
71531	1	UNIVERSAL JOINT 1/2"
73531	1	IMPACT UNIVERSAL JOINT 1/2"
71632	1	ADAPTOR FOR EXTENSION 1/2"(F) X 3/8"(M)
7133250	1	SLIDING T HANDLE 1/2"
7143125...250	2	EXTENSION 1/2" 125, 250MML
7273380	1	SWIVEL GRIP HANDLE 1/2" 380MML
7233600	1	SWIVEL HANDLE 1/2" 600MML
83410006...8	3	BIT SOCKET HEX 1/2", 100MML 6, 7, 8MM
83606227...60	7	BIT SOCKET TX 1/2", T27, T30, T40, T45, T50, T55, T60

ART. NO.	PCS	DESCRIPTION LOOSE ITEMS
83610040...55	4	BIT SOCKET TX 1/2", 100MML T40, T45, T50, T55
83706227...55	6	BIT SOCKET TAMPERPROOF 1/2", TX T27H, T30H, T40H, T45H, T50H, T55H
83710040	1	BIT SOCKET TAMPERPROOF 1/2", TX 100MML T40H
83806206...16	6	BIT SOCKET SPLINE 1/2", M6, M8, M10, M12, M14, M16
83810006...18	5	BIT SOCKET SPLINE 1/2", 100MML M6, M8, M10, M12, M14
86807818	1	IMPACT BIT SOCKET XZN 1/2", 78MML M18
47017	1	MULTIMETER AC/DC
47018	1	MULTIMETER AC/DC
47022	1	VOLT CIRCUIT TESTER 6-24V
48023	1	JACK STANDS, 3 TON
48025	1	SCISSOR JACK 1 TON
101002	1	TX SOCKET SET 1/4", TX ON RAIL 10-PCS
101004	1	BIT SOCKET SET 1/4", TX ON RAIL 10-PCS
104602	1	FLANK SOCKET SET BMCS 1/4", 6 PT. 46-PCS
201001	1	SOCKET SET 3/8", ON RAIL 10-PCS
201002	1	SOCKET SET 3/8", TX ON RAIL 10-PCS
201003	1	BIT SOCKET SET 3/8", HEX ON RAIL 10-PCS
201005	1	BIT SOCKET SET 3/8", TX ON RAIL 10-PCS
201006	1	BIT SOCKET SET 3/8", TX TAMPERPROOF ON RAIL 10-PCS
201201	1	BIT SOCKET SET 3/8", RIBE & TRIPLE SQUARE ON RAIL 12PT.
206102	1	SOCKET & BITSOCKET SET BMCS 3/8", 61-PCS
300301	1	WHEEL SOCKET SET 1/2", 3-PCS
300603	1	ADAPTOR SET 6-PCS
300902	1	SOCKET 1/2", TX SET ON RAIL 9-PCS
301007	1	SOCKET SET ON RAIL 1/2", 10-PCS
304201	1	BIT SET 10MML 42-PCS
309402	1	SOCKETSET IN SUITCASE BMCS 94-PCS
600308	1	HOSE LINE CLAMP SET 3-PCS
600401	1	MINI HOOK SET 4-PCS
600512	1	SCREWDRIVER SET IN COLOUR BOX 5-PCS
600507	1	FLEXIBLE FLARE NUT WRENCH SET 5-PCS
600624	1	PIN PUNCH SET 6-PCS
600813	1	TX KEY SET (FOLDING) 8-PCS
600902	1	TX WRENCH, EXTRA LONG KEY SET 9-PCS
601001	1	16 IN 1 RATCHET SCREWDRIVER
601006	1	HEX BALL LONG KEY SET 10-PCS
601007	1	HEXAGON KEY WRENCH, EXTRA LONG SET 10-PCS
601008	1	HEX BALL EXTRA LONG KEY SET 10-PCS
601702	1	COMBINATION WRENCH SET IN POUCH, 17-PCS
801016	1	BRAKE CALIPER SERVICE SET, PNEUMATIC 16-PCS
801018	1	BRAKE CALIPER SERVICE SET 18-PCS
802214	1	DRAIN PLUG KEY SET 3/8", 14-PCS
803005	1	PRY REMOVER SET 5-PCS
805001	1	GLOW PLUG SOCKET SET 3/8", 3-PCS
806001	1	ALTERNATOR TOOLS 13-PCS
807001	1	HUB NUT IMPACT SOCKET SET 1/2", 12-PT. 3-PCS
813001	1	CRIMPING PLIER SET WITH EXCHANGEABLE HEADS 7-PCS
813003	1	WIRE STRIPPER 0.2-6.0MM 200L
821001	1	PRY REMOVAL MASTER KIT 27-PCS
4800102	1	BOTTLE JACK 2 TON
4800104	1	BOTTLE JACK 4 TON
4820503	1	STRIP LED WORK LIGHT + TOP TORCH, 2W
4820505	1	SMD LED PORTABLE WORK LIGHT 12V 240V, 2.5W
4821103	1	TXLIGHT INSPECTIONS WORK LIGHT WITH 11W FLUORESCENT TUBE
4821105	1	FLASH PEN
4820509	1	RECHARGEABLE COB WORK LIGHT 3W
4831201	1	CROSS RIM WRENCH, 350MM, 17, 19, 22, 13/16"
4821701	1	NITRILE COATED GLOVE, PAIR, NYLON LINER SIZE 8 (M)
4821702	1	NITRILE COATED GLOVE, PAIR, NYLON LINER SIZE 9 (L)
4821703	1	NITRILE COATED GLOVE, PAIR, NYLON LINER SIZE 10 (XL)

709412

WALLDISPLAY 1 MTR. WITH 94 ITEMS

ART. NO.	PCS	DESCRIPTION LOOSE ITEMS
1310...12	3	SCREWDRIVER, PH.0, PH.1, PH.2
13303...65	3	SCREWDRIVER, SLOTTED 3, 4, 6,5MM
47537	1	FLEXIBLE SOCKET SCREWDRIVER, HEX 7MM
47903	1	SCRAPER
3310115...22	5	WHEEL SOCKET 1/2", 6PT. 15, 17, 19, 21, 22MM
3397824...27	2	IMPACT DEEP SOCKET 1/2", 12PT. 24, 27MM
3398534...36	3	1/2" 12PT. IMPACT DEEP SOCKET 34, 35, 36MM
41506...24	16	COMBINATION WRENCH 6, 7, 8, 9, 10, 11, 12, 13, 14, 15, 16, 17, 19, 21, 22, 24MM
4170208...19	5	REVERSIBLE RATCHETING WRENCH 12PT. 8, 10, 13, 17, 19MM
42301250	1	ADJUSTABLE WRENCH 10"
4311175	1	COMBINATION PLIERS 7"
4321200	1	LONG NOSE PLIERS 8"
4331200	1	BENT LONG NOSE PLIERS 8"
4341175	1	DIAGONAL PLIERS 7"
4351250	1	WATERPUMP PLIERS 10"
4380250	1	LOCKING PLIERS 10"
4611400	1	MACHINIST HAMMER 400GR. FIBRE HANDLE TPR COVER
4620400	1	SAND FILLED HAMMER 400GR.
4631000	1	STONING HAMMER 1000 GR FIBRE HANDLE TPR COVER
46806	1	UTILITY KNIFE INCLUDING 10 BLADES
47013	1	MEASURING TAPE 5 METER
47022	1	VOLT CIRCUIT TESTER 6-24V
7110301	1	DISC RATCHET 1/4", 72 TEETH
7120901	1	RATCHET HANDLE 1/4" -45 TEETH
7141050...150	2	EXTENSION 1/4" 50, 150MML
71511	1	UNIVERSAL JOINT 1/4"
7110302	1	DISC RATCHET 3/8", 72 TEETH
7120902	1	RATCHET HANDLE 3/8" -45 TEETH
7142075...150	2	EXTENSION 3/8" 75, 150MML
71521	1	UNIVERSAL JOINT 3/8"
7172216...21	3	SPARK PLUG 3/8" CLIP SOCKET 16, 18, 21MM
7232200	1	SWIVEL HANDLE 3/8" 200MML
7120903	1	RATCHET HANDLE 1/2" -45 TEETH
7133250	1	SLIDING T HANDLE 1/2"
7143125...250	2	EXTENSION 1/2" 125, 250MML
71531	1	UNIVERSAL JOINT 1/2"
100904	1	BIT SOCKET SET 1/4", HEX ON RAIL 9-PCS
101001	1	SOCKET SET 1/4", ON RAIL 10-PCS
101002	1	TX-E SOCKET SET 1/4", TX ON RAIL 10-PCS
101004	1	BIT SOCKET SET 1/4", TX ON RAIL 10-PCS
104602	1	FLANK SOCKET SET BMCS 1/4", 6 PT. 46-PCS
201001	1	SOCKET SET 3/8", ON RAIL 10-PCS
201002	1	SOCKET SET 3/8", TX-E ON RAIL 10-PCS
201003	1	BIT SOCKET SET 3/8", HEX ON RAIL 10-PCS
201005	1	BIT SOCKET SET 3/8", TX ON RAIL 10-PCS
206101	1	SOCKET & BITSOCKET SET 3/8", 61-PCS
300902	1	SOCKET 1/2", TX-E SET ON RAIL 9-PCS
301003	1	BIT SOCKET HEX SET ON RAIL 1/2", 10-PCS
301005	1	BIT SOCKET TX 1/2", SET ON RAIL 10-PCS
301201	1	SOCKET ON RAIL 1/2", 12-PCS
309402	1	SOCKETSET IN SUITCASE BMCS 94-PCS
600618	1	6PCS SCREWDRIVER SET IN COLOUR BOX
600619	1	6PCS SCREWDRIVER SET TX IN COLOUR BOX
600620	1	6PCS SCREWDRIVER SET TX-H IN COLOUR BOX
600902	1	TX WRENCH, EXTRA LONG KEY SET 9-PCS
601008	1	HEX BALL EXTRA LONG KEY SET 10-PCS
601702	1	COMBINATION WRENCH SET IN POUCH, 17-PCS
602002	1	SCREWDRIVER SET, 20-PCS
803005	1	PRY REMOVER SET 5-PCS.



10



724912

WALLDISPLAY 2 MTR. WITH 249 ITEMS

ART. NO.	PCS	DESCRIPTION LOOSE ITEMS
100904	1	BIT SOCKET SET 1/4", HEX ON RAIL 9-PCS
101001	1	SOCKET SET 1/4", ON RAIL 10-PCS
101002	1	TX-E SOCKET SET 1/4", TX ON RAIL 10-PCS
101004	1	BIT SOCKET SET 1/4", TX ON RAIL 10-PCS
104602	1	FLANK SOCKET SET BMCS 1/4", 6 PT. 46-PCS
12425008...10	2	SOCKET SCREWDRIVER, HEX 8, 10MM (S)
1310...13	4	SCREWDRIVER, PH.0, PH.1, PH.2, PH.3
13303...08	3	SCREWDRIVER, SLOTTED 3, 4, 8MM
13335...65	3	SCREWDRIVER, SLOTTED 3.5, 5.5, 6.5MM
13610...40	7	SCREWDRIVER, TX T10, T15, T20, T25, T27, T30, T40
14423008...10	2	SOCKET SCREWDRIVER, HEX T HANDLE 8, 10MM (S)
201001	1	SOCKET SET 3/8", ON RAIL 10-PCS
201002	1	SOCKET SET 3/8", TX-E ON RAIL 10-PCS
201003	1	BIT SOCKET SET 3/8", HEX ON RAIL 10-PCS
201005	1	BIT SOCKET SET 3/8", TX ON RAIL 10-PCS
203703	1	SOCKET AND WRENCH SET 3/8", BMCS 37-PCS
206102	1	SOCKET & BITSOCKET SET BMCS 3/8", 61-PCS
21504...13	10	FLANK SOCKET 1/4", 6 PT. 4, 5, 6, 7, 8, 9, 10, 11, 12, 13MM
2155004...13	11	FLANK DEEP SOCKET 1/4", 6 PT. 4, 5, 5.5, 6, 7, 8, 9, 10, 11, 12, 13MM

ART. NO.	PCS	DESCRIPTION LOOSE ITEMS
21555	1	FLANK SOCKET 1/4", 6 PT. 5.5MM
21608...10	2	SOCKET 1/4", TX E8, E10
2165008...10	2	SOCKET 1/4", TX DEEP E8, E10
22507...22	14	FLANK SOCKET 3/8", 6 PT. 7, 8, 10, 11, 12, 13, 14, 15, 16, 17, 18, 19, 21, 22MM
2256307...19	12	FLANK SOCKET 3/8", 6 PT. DEEP 7, 8, 10, 11, 12, 13, 14, 15, 16, 17, 18, 19MM
23510...27	16	FLANK SOCKET 1/2", 6 PT. 10, 11, 12, 13, 14, 15, 16, 17, 18, 19, 20, 21, 22, 23, 24, 27MM
2357710...30	13	FLANK SOCKET 1/2", 6 PT. DEEP 10, 12, 13, 14, 15, 16, 17, 18, 19, 21, 22, 24, 30MM
300301	1	WHEEL SOCKET SET 1/2", 3-PCS
300603	1	ADAPTOR SET 6-PCS
300902	1	SOCKET 1/2", TX-E SET ON RAIL 9-PCS
301003	1	BIT SOCKET HEX SET ON RAIL 1/2", 10-PCS
301005	1	BIT SOCKET TX 1/2", SET ON RAIL 10-PCS
301201	1	SOCKET ON RAIL 1/2", 12PT.CS
302404	1	SOCKET SET BMCS 1/2", 24-PCS
304201	1	BIT SET 10MML 42-PCS
309402	1	SOCKETSET IN SUITCASE BMCS 94-PCS
3310115...22	5	WHEEL SOCKET 1/2", 6PT. 15, 17, 19, 21, 22MM
3358513...32	10	IMPACT SOCKET 1/2", 6PT. DEEP 13, 15, 17, 19, 21, 22, 24, 27, 30, 32MM

ART. NO.	PCS	DESCRIPTION LOOSE ITEMS
3397824...27	2	IMPACT DEEP SOCKET 1/2", 12PT. 24, 27 MM
3398534...36	3	1/2" 12PT. IMPACT DEEP SOCKET 34, 35, 36
41506...32	21	COMBINATION WRENCH 6, 7, 8, 9, 10, 11, 12, 13, 14, 15, 16, 17, 18, 19, 20, 21, 22, 24, 27, 30, 32MM
4170208...19	11	REVERSIBLE RATCHETING WRENCH 12PT. 8, 10, 11, 12, 13, 14, 15, 16, 17, 18, 19MM
4170210	10	REVERSIBLE RATCHETING WRENCH 12PT.10, 11, 12, 13, 14, 15, 16, 17, 18, 19MM
4311175	1	COMBINATION PLIERS 7"
4321200	1	LONG NOSE PLIERS 8"
4331200	1	BENT LONG NOSE PLIERS 8"
4341175	1	DIAGONAL PLIERS 7"
4351250	1	WATERPUMP PLIERS 10"
4380250	1	LOCKING PLIERS 10"
4410265	1	RIVETING PLIER 10.5"
4450300	1	OIL FILTER PLIERS 12"
4471250	1	WIRE STRIPPER 10"
4472100	1	FLEXIBLE CABLE HOSE CLAMP REMOVING PLIERS
45110141	1	GRIP CHISEL 140MML 10
45112160	1	GRIP CHISEL 160MML 12
45118190	1	GRIP CHISEL 190MML 18
45124220	1	GRIP CHISEL 220MML 24
4527190	1	GRIP CAPE CHISEL 190MML 7
4533150	1	GRIP PIN PUNCH 150MML 3"
4534180	1	GRIP PIN PUNCH 180MML 4"
4535200	1	GRIP PIN PUNCH 200MML 5"
4536210	1	GRIP PIN PUNCH 210MML 6"
4564185	1	GRIP CENTER PUNCH 185MML 4"
4611400	1	MACHINIST HAMMER 400GR. FIBRE HANDLE TPR COVER
4620400	1	SAND FILLED HAMMER 400GR.
4631000	1	STONING HAMMER 1000 GR FIBRE HANDLE TPR COVER
46807	1	UTILITY KNIFE INCLUDING 13 BLADES
47002	1	FEELER GAUGE 26-PCS.
47013	1	MEASURING TAPE 5 METER
47015	1	INFRARED THERMOMETER GUN TYPE
47022	1	VOLT CIRCUIT TESTER 6-24V
47537	1	FLEXIBLE SOCKET SCREWDRIVER, HEX 7MM
47902	1	DOOR UPHOLSTERY PANEL REMOVER 110MML
47903	1	SCRAPER
4820110	1	MAGNET EXTENDABLE

ART. NO.	PCS	DESCRIPTION LOOSE ITEMS
4831101	1	FLAT CHISEL 240MML 26"
600618	1	6PCS SCREWDRIVER SET IN COLOUR BOX
600619	1	6PCS SCREWDRIVER SET TX IN COLOUR BOX
600620	1	6PCS SCREWDRIVER SET TX-H IN COLOUR BOX
600813	1	TX KEY SET (FOLDING) 8-PCS
600902	1	TX WRENCH, EXTRA LONG KEY SET 9-PCS
600904	1	COMBINATION WRENCH SET IN POUCH 9-PCS
601001	1	16 IN 1 RATCHET SCREWDRIVER
601006	1	HEX BALL LONG KEY SET 10-PCS
601008	1	HEX BALL EXTRA LONG KEY SET 10-PCS
601702	1	COMBINATION WRENCH SET IN POUCH, 17-PCS
602002	1	SCREWDRIVER SET, 20-PCS
7110101	1	FLEXIBLE RATCHET 1/4", 45 TEETH
7110301	1	DISC RATCHET 1/4", 72 TEETH
7110302	1	DISC RATCHET 3/8", 72 TEETH
7120302	1	EXTENDABLE RATCHET 3/8"-72 TEETH
7120701	1	RATCHET HANDLE 1/4"-72 TEETH
7120901	1	RATCHET HANDLE 1/4"-45 TEETH
7120902	1	RATCHET HANDLE 3/8"-45 TEETH
7120903	1	RATCHET HANDLE 1/2"-45 TEETH
7133250	1	SLIDING T HANDLE 1/2"
7141050...150	2	EXTENSION 1/4" 50, 150MML
7142075...150	2	EXTENSION 3/8" 75, 150MML
7143125...250	2	EXTENSION 1/2" 125, 250MML
71511	1	UNIVERSAL JOINT 1/4"
71521	1	UNIVERSAL JOINT 3/8"
71531	1	UNIVERSAL JOINT 1/2"
7172216...21	3	SPARK PLUG 3/8" CLIP SOCKET 16, 18, 21MM
7174214	1	SPARK PLUG SOCKET 12-PT. 3/8" 14MM (90MML)
7175214	1	SPARK PLUG SOCKET 12-PT. 3/8" 14MM (250MML)
7232200	1	SWIVEL HANDLE 3/8" 200MML
73220550	1	TORQUES WRENCH 3/8" 5-50NM
732320200	1	TORQUES WRENCH 1/2" 20-200NM
801018	1	BRAKE CALIPER SERVICE SET 18-PCS.
805001	1	GLOW PLUG SOCKET SET 3/8", 3-PCS.
813003	1	WIRE STRIPPER 0.2-6.0MM 200L
820005	1	FUEL LINE DISCONNECT SET 3-PCS.
821001	1	PRY REMOVAL MASTER KIT 27-PCS.

ART. NO.	DESCRIPTION
47529	WALLDISPLAY EMPTY 1 METER
47530	WALLDISPLAY EMPTY 2 METER
47531	WALLDISPLAY EMPTY 3 METER
47532	WALLDISPLAY EMPTY 4 METER
47533	WALLDISPLAY EMPTY 5 METER
47534	LIGHT BOX SONIC
47535	SINGLE HOOK L10 Ø4MM

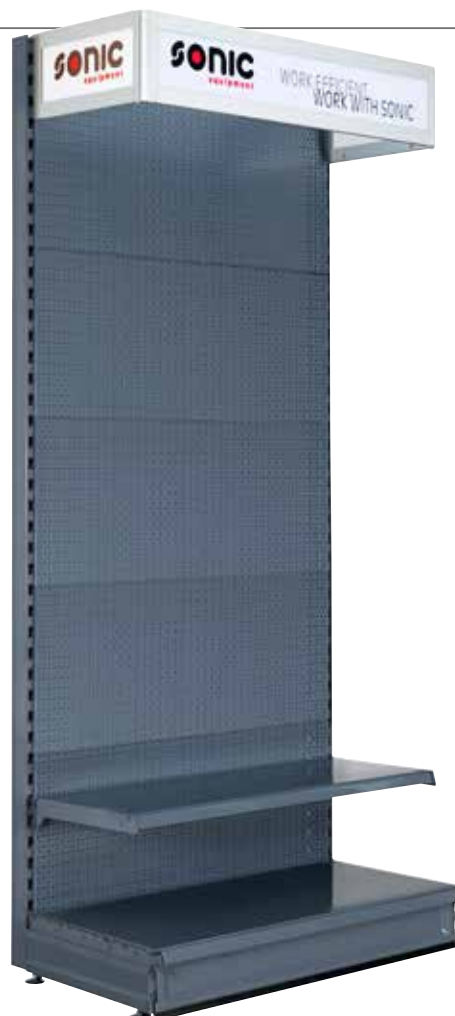



C. ABT AUDI

SAE Tools

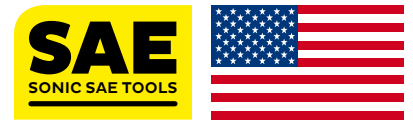

601003



HEXAGON KEY WRENCH, EXTRA LONG SET 10-PCS

ART. NO.	PCS	CONTENTS
1850601...10	10	BALL ENDED HEXAGON KEY WRENCH 1/16", 5/64", 3/32", 1/8", 5/32", 3/16", 7/32", 1/4", 5/16", 3/8"

100901



SOCKET SET 1/4", ON RAIL 9-PCS

ART. NO.	DESCRIPTION
21905...13	SOCKET 1/4", 12 PT. 3/16", 7/32", 1/4", 9/32", 5/16", 11/32", 3/8", 7/16", 1/2"

100902



DEEP SOCKET SET 1/4", ON RAIL 9-PCS

ART. NO.	DESCRIPTION
2195005...12	SOCKET 1/4", 12 PT. DEEP 3/16", 7/32", 1/4", 9/32", 5/16", 11/32", 3/8", 7/16", 1/2"

100702



BIT SOCKET SET 1/4", HEX ON RAIL 7-PCS

ART. NO.	DESCRIPTION
81413703...10	BIT SOCKET HEX 1/4" 1/8", 5/32", 3/16", 7/32", 1/4", 5/16", 3/8"

200801



SOCKET SET 3/8", ON RAIL 8-PCS

ART. NO.	DESCRIPTION
22910...21	SOCKET 3/8" 12 PT. 3/8", 7/16", 1/2", 9/16", 5/8", 11/16", 3/4", 13/16"

200802



DEEP SOCKET SET 3/8", ON RAIL 8-PCS

ART. NO.	DESCRIPTION
2296310...21	SOCKET 3/8", 12 PT. 3/8", 7/16", 1/2", 9/16", 5/8", 11/16", 3/4", 13/16"

200902



BIT SOCKET SET 3/8", HEX ON RAIL 9-PCS

ART. NO.	DESCRIPTION
82414803...13	BIT SOCKET HEX 3/8" 1/8", 5/32", 3/16", 7/32", 1/4", 5/16", 3/8", 7/16", 1/2"

301503



SOCKET SET 1/2", ON RAIL 15-PCS

ART. NO.	DESCRIPTION
23910...32	SOCKET 1/2", 12 PT. 3/8", 7/16", 1/2", 9/16", 5/8", 11/16", 3/4", 13/16", 7/8", 15/16", 1", 1.1/16", 1.1/8", 1.3/16", 1.1/4"

301504



DEEP SOCKET SET 1/2", ON RAIL 15-PCS

ART. NO.	DESCRIPTION
2397710...32	SOCKET 1/2", 12 PT. DEEP 3/8", 7/16", 1/2", 9/16", 5/8", 11/16", 3/4", 13/16", 7/8", 15/16", 1", 1.1/16", 1.1/8", 1.3/16", 1.1/4"

301002



BIT SOCKET SET 1/2", HEX ON RAIL 10-PCS

ART. NO.	DESCRIPTION
834106205...17	BIT SOCKET HEX 1/2" 3/16", 1/4", 9/32", 5/16", 11/32", 3/8", 7/16", 1/2", 9/16", 5/8"

601204



COMBINATION WRENCH SET 12-PCS

ART. NO.	PCS	CONTENTS
4150206...24	12	COMBINATION WRENCH 1/4", 5/16", 3/8", 7/16", 1/2", 9/16", 5/8", 11/16", 3/4", 13/16", 7/8", 15/16"

600806



DOUBLE OPEN WRENCH SET 8-PCS

ART. NO.	PCS	CONTENTS
4220608...2932	8	DOUBLE OPEN WRENCH 1/4"x5/16", 3/8"x7/16", 1/2"x9/16", 5/8"x11/16", 11/16"x3/4", 13/16"x7/8", 15/16"x1", 1.1/8"x1.1/4"

600402



FLARE NUT WRENCH SET 4-PCS

ART. NO.	PCS	CONTENTS
4250608...1617	4	FLARE NUT WRENCH 1/4"x5/16", 3/8"x7/16", 1/2"x9/16", 5/8"x11/16"

600701



45° OFFSET RING WRENCH SET 7-PCS

ART. NO.	PCS	CONTENTS
4270608...2425	7	45° OFFSET RING WRENCH 1/4"x5/16", 3/8"x7/16", 1/2"x9/16", 9/16"x5/8", 11/16"x3/4", 13/16"x7/8", 15/16"x1"

106304

E1/3, 1/4" SOCKET BIT SAE SET, 63-PCS

ART. NO.	CONTENTS
21905...13	9 1/4" 12PT. FLANK SOCKET 3/16", 7/32", 1/4", 9/32", 5/16", 11/32", 3/8", 7/16", 1/2"
21604...10	6 1/4" STAR SOCKET E4, E5, E6, E7, E8, E10
601006	10 10-PCS HEX BALL LONG KEY SET
7120901	1 1/4" RATCHET HANDLE-45 TEETH
7110301	1 1/4" DISC RATCHET-72 TEETH
72401	1 1/4" SPINNER 150MML-6"
7141050...150	3 1/4" EXTENSION 50, 100, 150MML
71511	1 1/4" UNIVERSAL JOINT
72225	1 1/4" MAGNETIC SOCKET PICK-UP
8113701...02	2 1/4" PHILLIPS SOCKET BIT PH.1, PH.2
81413703...08	6 1/4" HEX SOCKET BIT 1/8", 5/32", 3/16", 7/32", 1/4", 5/16"
8163706...40	11 1/4" STAR SOCKET BIT T6, T7, T8, T9, T10, T15, T20, T25, T27, T30, T40
8173706...40	11 1/4" STAR T. SOCKET BIT T6H, T7H, T8H, T9H, T10H, T15H, T20H, T25H, T27H, T30H, T40H

204102

E1/3, 3/8" SOCKET BIT SAE SET, 41-PCS

ART. NO.	CONTENTS
22906...18	10 3/8" 12PT. FLANK SOCKET 1/4", 5/16", 3/8", 7/16", 1/2", 9/16", 5/8", 11/16", 3/4", 13/16"
22607...18	8 3/8" STAR SOCKET E7, E8, E10, E11, E12, E14, E16, E18
7120902	1 3/8" RATCHET HANDLE-45 TEETH
7110302	1 3/8" DISC RATCHET-72 TEETH
7172214	1 3/8" 12PT. SPARK PLUG CLIP SOCKET 14
7171216	3 3/8" SPARK PLUG SOCKET 16, 18, 21
7142044...75	2 3/8" EXTENSION 44, 75MML
7142150...200	2 3/8" EXTENSION 150, 200MML
71521	1 3/8" UNIVERSAL JOINT
82414805...12	6 3/8" HEX SOCKET BIT 3/16", 7/32", 1/4", 5/16", 3/8", 7/16"
8264825...50	6 3/8" STAR SOCKET BIT T25, T27, T30, T40, T45, T50

202302



E1/3, 3/8" LONG SOCKET SAE SET, 23-PCS

ART. NO.	CONTENTS
2296310...21	8 3/8" 12PT FLANK DEEP SOCKET 3/8", 7/16", 1/2", 9/16", 5/8", 11/16", 3/4", 13/16"
7152610...16	4 3/8" STAR CARDAN SOCKET E10, E12, E14, E16
71521	1 3/8" UNIVERSAL JOINT
2266306...20	10 3/8" STAR DEEP SOCKET E6, E7, E8, E10, E11, E12, E14, E16, E18, E20

302005

E1/3, 1/2" COMBINATION SAE SET, 20-PCS

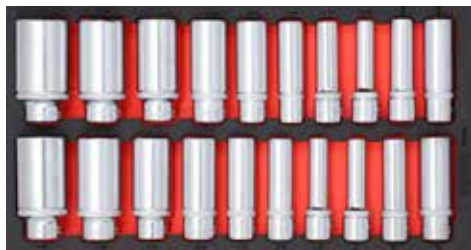
ART. NO.	CONTENTS
23910...32	15 1/2" 12PT. FLANK SOCKET 3/8", 7/16", 1/2", 9/16", 5/8", 11/16", 3/4", 13/16", 7/8", 15/16", 1", 1.1/16", 1.1/8", 1.3/16", 1.1/4"
7120903	1 1/2" RATCHET HANDLE-45 TEETH
7143125...250	2 1/2" EXTENSION 125, 250MML
71531	1 1/2" UNIVERSAL JOINT
71623	1 ADAPTOR FOR EXT. 3/8"(F)X1/2"(M)

302004

E1/3, 1/2" DEEP SOCKET SAE SET, 20-PCS

ART. NO.	CONTENTS
2397710...32	15 1/2" 12PT. FLANK DEEP SOCKET 3/8", 7/16", 1/2", 9/16", 5/8", 11/16", 3/4", 13/16", 7/8", 15/16", 1", 1.1/16", 1.1/8", 1.3/16", 1.1/4"
2367714...22	5 1/2" STAR DEEP SOCKET E14, E16, E18, E20, E22

303806

E1/3, 1/2" SOCKET BIT SAE SET, 38-PCS

ART. NO.	CONTENTS
23910...32	15 1/2" 12PT FLANK SOCKET 3/8", 7/16", 1/2", 9/16", 5/8", 11/16", 3/4", 13/16", 3/4", 7/8", 15/16", 1", 1.1/16", 1.1/8", 1.3/16", 1.1/4"
23610...24	8 1/2" STAR SOCKET E10, E11, E12, E14, E16, E18, E20, E24
834106205...17	10 1/2" HEX SOCKET BIT 3/16", 1/4", 9/32", 5/16", 11/32", 3/8", 7/16", 1/2", 9/16", 5/8"
83606245...70	5 1/2" STAR SOCKET BIT T45, T50, T55, T60, T70

601406

E1/3 COMBINATION WRENCH SAE SET, 14-PCS

ART. NO.	CONTENTS
4150206...27	14 COMBINATION WRENCH 1/4", 5/16", 3/8", 7/16", 1/2", 9/16", 5/8", 11/16", 3/4", 13/16", 7/8", 15/16", 1", 1.1/16"

309301



SOCKET SET 12PT. SFS 1/4" 3/8" 12", 93-PCS

ART. NO.	CONTENTS
21905...13	9 SOCKET 1/4", 12 PT. 3/16", 7/32", 1/4", 9/32", 5/16", 11/32", 3/8", 7/16", 1/2"
2195005...12	9 SOCKET 1/4", 12 PT. DEEP 3/16", 7/32", 1/4", 9/32", 5/16", 11/32", 3/8", 7/16", 1/2"
22910...19	7 SOCKET 3/8", 12 PT. 3/8", 7/16", 1/2", 9/16", 5/8", 11/16", 3/4"
2296310...19	7 SOCKET 3/8", 12 PT. DEEP 3/8", 7/16", 1/2", 9/16", 5/8", 11/16", 3/4"
23921...32	8 SOCKET 1/2", 12 PT. 13/16", 7/8", 15/16", 1", 1.1/16", 1.1/8", 1.3/16", 1.1/4"
2397721...32	8 SOCKET 1/2", 12 PT. DEEP 13/16", 7/8", 15/16", 1", 1.1/16", 1.1/8", 1.3/16", 1.1/4"
81413703...06	4 BIT SOCKET HEX 1/4" 1/8", 5/32", 3/16", 7/32"
82414803...13	9 BIT SOCKET HEX 3/8", 1/8", 5/32", 3/16", 7/32", 1/4", 5/16", 3/8", 7/16", 1/2"
834106210...17	5 BIT SOCKET HEX 1/2" 3/8", 7/16", 1/2", 9/16", 5/8"
601003	10 HEXAGON KEY WRENCH, EXTRA LONG SET 10-PCS
7110201	1 ROTOR RATCHET 1/4", 72 TEETH
7110301	1 DISC RATCHET 1/4", 72 TEETH
7141050...150	3 EXTENSION 1/4" 50MML, 100MML, 150MML
7110202	1 ROTOR RATCHET 3/8", 72 TEETH
7110302	1 DISC RATCHET 3/8", 72 TEETH
7142044...250	4 EXTENSION 3/8" 44MML, 75MML, 150MML, 250MML
71521	1 UNIVERSAL JOINT 3/8"
71632	1 ADAPTOR FOR EXTENSION 1/2"(F) X 3/8"(M)
7110203	1 ROTOR RATCHET 1/2", 72 TEETH
7143125...250	2 EXTENSION 1/2" 125MML, 250MML
71531	1 UNIVERSAL JOINT 1/2"

310001



SOCKET SET 1/4", 3/8" & 1/2", 12 PT. SFS 100-PCS

ART. NO.	CONTENTS
21905...13	9 SOCKET 1/4", 12 PT. 3/16", 7/32", 1/4", 9/32", 5/16", 11/32", 3/8", 7/16", 1/2"
2195005...12	9 SOCKET 1/4", 12 PT. DEEP 3/16", 7/32", 1/4", 9/32", 5/16", 11/32", 3/8", 7/16", 1/2"
22910...21	8 SOCKET 3/8", 12 PT. 3/8", 7/16", 1/2", 9/16", 5/8", 11/16", 3/4", 13/16"
2296310...21	8 SOCKET 3/8", 12 PT. DEEP 3/8", 7/16", 1/2", 9/16", 5/8", 11/16", 3/4", 13/16"
23910...32	15 SOCKET 1/2", 12 PT. 3/8", 7/16", 1/2", 9/16", 5/8", 11/16", 3/4", 13/16", 7/8", 15/16", 1", 1.1/16", 1.1/8", 1.3/16", 1.1/4"
2397710...32	15 SOCKET 1/2", 12 PT. DEEP 3/8", 7/16", 1/2", 9/16", 5/8", 11/16", 3/4", 13/16", 7/8", 15/16", 1", 1.1/16", 1.1/8", 1.3/16", 1.1/4"
81413703...10	7 BIT SOCKET HEX 1/4" 1/8", 5/32", 3/16", 7/32", 1/4", 5/16", 3/8"
82414803...13	9 BIT SOCKET HEX 3/8", 1/8", 5/32", 3/16", 7/32", 1/4", 5/16", 3/8", 7/16", 1/2"
834106205...17	10 BIT SOCKET HEX 1/2" 3/8", 7/16", 1/2", 9/16", 5/8"
601003	10 HEXAGON KEY WRENCH, EXTRA LONG SET 10-PCS

603101



WRENCH SET SFS, 31-PCS

ART. NO.	CONTENTS
4150206...24	12 COMBINATION WRENCH 1/4", 5/16", 3/8", 7/16", 1/2", 9/16", 5/8", 11/16", 3/4", 13/16", 7/8", 1 5/16"
4220608...2932	8 DOUBLE OPEN WRENCH 1/4"X5/16", 3/8"X7/16", 1/2"X9/16", 5/8"X11/16", 11/16"X3/4", 13/16"X7/8", 15/16"X1", 1.1/8"X1.1/4"
4270608...2425	7 45° OFFSET RING WRENCH 1/4"X5/16", 3/8"X7/16", 1/2"X9/16", 9/16"X5/8", 11/16"X3/4", 13/16"X7/8", 15/16"X1"
4250608...1617	4 FLARE NUT WRENCH 1/4"X5/16", 3/8"X7/16", 1/2"X9/16", 5/8"X11/16"

ART. NO. 716931

4 DRAWERS FILLED WITH 171-PCS TOOLS

MAIN FEATURES

- 8 DRAWERS WITH BALL BEARING SLIDES
- DRAWER BLOCKING SYSTEM, AS PROTECTION AGAINST TIPPING OVER
- STAINLESS STEEL TOPBLADE
- CAN HOLDER
- FRONT CENTRALIZED SAFETY LOCK
- FULLY (100%) RETRACTABLE DRAWERS
- POWDER COATING EXTERIOR
- 4X EXTRA LARGE WHEELS Ø125MM, WHEREOF 2X CASTER WITH ROLLING AND TURNING BRAKE
- DRAWERS 2 + 3 SAE SET



1 602407

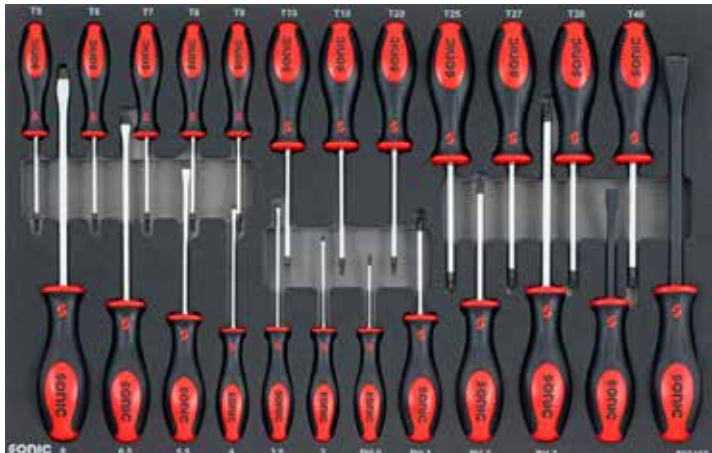

2 309301



3 603101



4 602302



357-PCS

ART. NO. 735231



5 DRAWERS FILLED WITH 357-PCS TOOLS

FOR DETAILS ABOUT THE SPECIFICATIONS OF THE TROLLEY, SEE CHAPTER EMPTY STORAGE SYSTEMS

FOR DETAILS ABOUT THE CONTENTS OF THE TROLLEY, SEE CHAPTER TOOLS SETS

i MORE INFO WWW.SONIC-EQUIPMENT.COM

1 602407

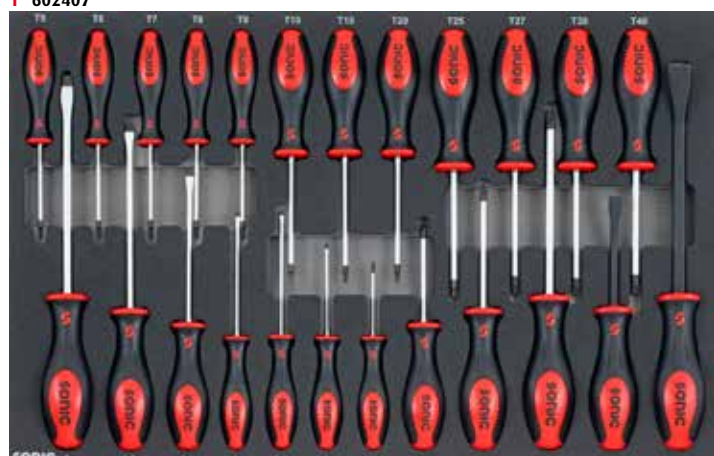

2 313902



3 604002

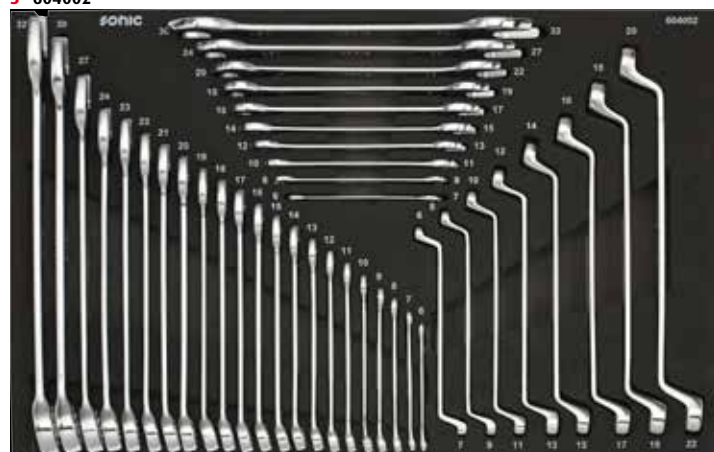

4 602302



5 310001

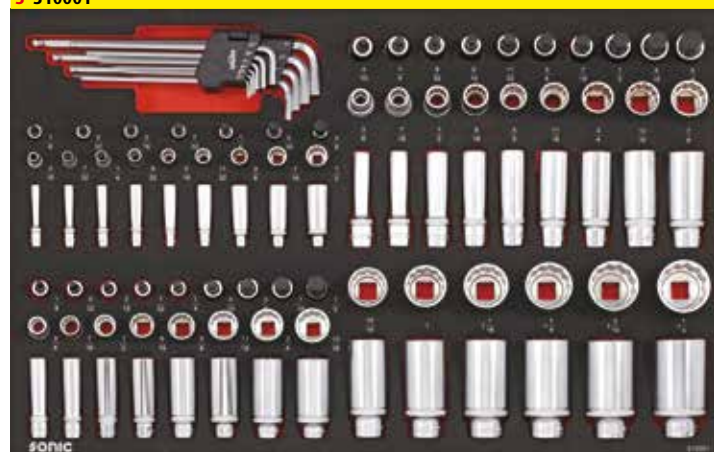

6 603101



77

SOCKET 1/4", 12 PT.

DIN NO. 3120

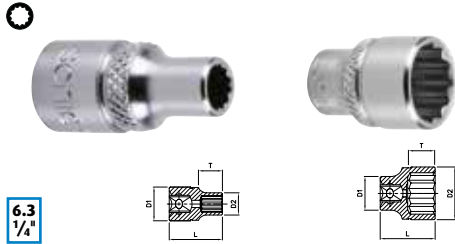

6.3
1/4"

ART. NO.	SIZE	L(MM)	D2(MM)	G	PCS/BAG
21905	3/16"	25,0	7,8	10	10
21955	7/32"	25,0	8,4	10	10
21906	1/4"	25,0	9,3	10	10
21907	9/32"	25,0	11,0	10	10
21908	5/16"	25,0	12,0	10	10
21909	11/32"	25,0	13,0	10	10
21910	3/8"	25,0	14,0	10	10
21911	7/16"	25,0	16,0	15	10
21913	1/2"	25,0	18,0	20	10

SOCKET 3/8", 12 PT. DEEP

DIN NO. 3120

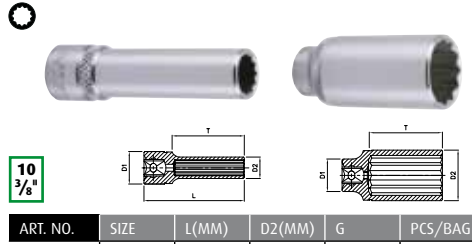

10
3/8"

ART. NO.	SIZE	L(MM)	D2(MM)	G	PCS/BAG
2296306	1/4"	63,0	14,5	45	10
2296308	5/16"	63,0	14,5	45	10
2296310	3/8"	63,0	14,5	45	10
2296311	7/16"	63,0	15,7	50	10
2296313	1/2"	63,0	18,0	65	10
2296314	9/16"	63,0	20,0	70	10
2296316	5/8"	63,0	22,0	85	10
2296317	11/16"	63,0	24,0	100	10
2296319	3/4"	63,0	26,0	115	10
2296321	13/16"	63,0	28,0	130	10

SOCKET 3/4", 12 PT.

DIN NO. 3120

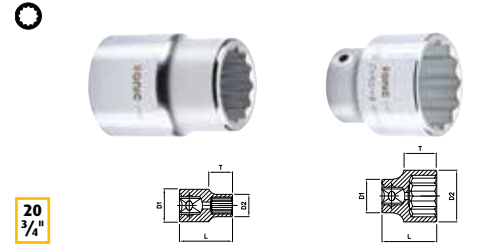

20
3/4"

ART. NO.	SIZE	L(MM)	D2(MM)	G	PCS/BAG
24819	3/4"	50,0	29,2	164	2
24822	7/8"	50,0	32,2	212	2
24824	5/16"	51,0	34,2	218	2
24825	1"	52,0	37,0	220	2
24827	1.1/16"	52,0	38,0	220	2
24829	1.1/8"	52,0	40,0	240	2
24830	1.3/16"	54,0	42,0	266	2
24832	1.1/4"	56,0	44,0	286	2
24833	1.5/16"	56,0	46,0	310	2
24835	1.3/8"	58,0	48,0	368	2
24836	1.7/16"	58,0	50,0	398	2
24838	1.1/2"	60,0	52,0	454	2
24841	1.5/8"	64,0	56,0	530	2
24842	1.11/16"	65,0	58,0	560	2
24844	1.3/4"	66,0	60,0	604	2
24846	1.13/16"	68,0	62,0	632	2
24847	1.7/8"	70,0	64,0	700	2
24850	2"	72,0	68,0	760	2

SOCKET 1/4", 12 PT. DEEP

DIN NO. 3120

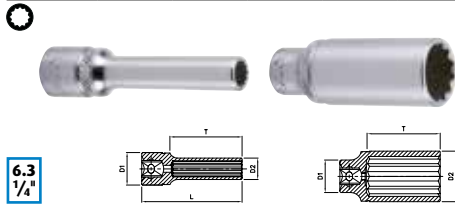

6.3
1/4"

ART. NO.	SIZE	L(MM)	D2(MM)	G	PCS/BAG
2195005	3/16"	50,0	7,2	15	10
21950055	7/32"	50,0	8,4	15	10
2195006	1/4"	50,0	9,3	20	10
2195007	9/32"	50,0	11,0	20	10
2195008	5/16"	50,0	12,0	20	10
2195009	11/32"	50,0	13,0	25	10
2195010	3/8"	50,0	14,0	30	10
2195011	7/16"	50,0	16,0	35	10
2195012	1/2"	50,0	18,0	45	10

SOCKET 1/2", 12 PT.

DIN NO. 3120

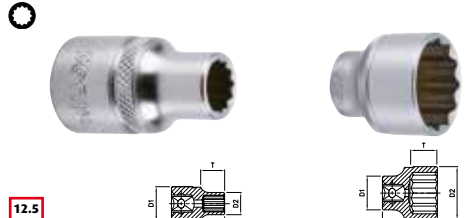

12.5
1/2"

ART. NO.	SIZE	L(MM)	D2(MM)	G	PCS/BAG
23910	3/8"	38,0	15,0	50	10
23911	7/16"	38,0	16,3	45	10
23913	1/2"	38,0	18,8	50	10
23914	9/16"	38,0	20,4	50	10
23916	5/8"	38,0	22,0	50	10
23917	11/16"	38,0	24,0	55	10
23919	3/4"	38,0	26,0	50	10
23921	13/16"	38,0	28,0	60	10
23922	7/8"	38,0	30,0	80	10
23924	15/16"	38,0	32,0	90	10
23925	1"	42,0	34,0	110	10
23927	1.1/16"	42,0	36,0	120	10
23929	1.1/8"	43,0	38,0	135	10
23930	1.3/16"	43,0	40,0	150	10
23932	1.1/4"	43,0	42,0	155	10

SOCKET 3/8", 12 PT.

DIN NO. 3120

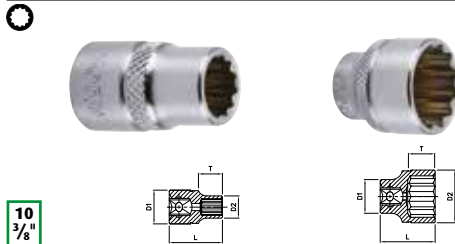

10
3/8"

ART. NO.	SIZE	L(MM)	D2(MM)	G	PCS/BAG
22906	1/4"	28,0	9,3	20	10
22908	5/16"	28,0	11,8	20	10
22910	3/8"	28,0	14,5	20	10
22911	7/16"	28,0	15,7	20	10
22913	1/2"	28,0	18,0	25	10
22914	9/16"	28,0	20,0	25	10
22916	5/8"	28,0	22,0	30	10
22917	11/16"	30,0	24,0	35	10
22919	3/4"	30,0	26,0	45	10
22921	13/16"	30,0	28,0	50	10

SOCKET 1/2", 12 PT. DEEP

DIN NO. 3120

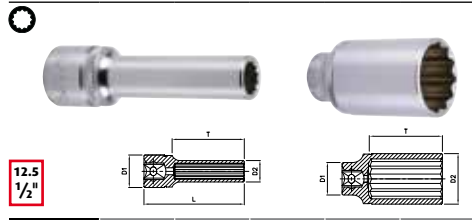

12.5
1/2"

ART. NO.	SIZE	L(MM)	D2(MM)	G	PCS/BAG
2397710	3/8"	77,0	15,0	65	10
2397711	7/16"	77,0	16,3	75	10
2397713	1/2"	77,0	18,8	90	10
2397714	9/16"	77,0	20,4	105	10
2397716	5/8"	77,0	22,0	95	10
2397717	11/16"	77,0	24,0	120	10
2397719	3/4"	77,0	26,0	135	10
2397721	13/16"	77,0	28,0	155	10
2397722	7/8"	77,0	30,0	190	10
2397724	15/16"	77,0	32,0	205	10
2397725	1"	77,0	34,0	235	10
2397727	1.1/16"	77,0	36,0	270	10
2397729	1.1/8"	77,0	38,0	300	10
2397730	1.3/16"	77,0	40,0	330	10
2397732	1.1/4"	77,0	42,0	355	10

BIT SOCKET HEX 1/4"

DIN NO. 3120

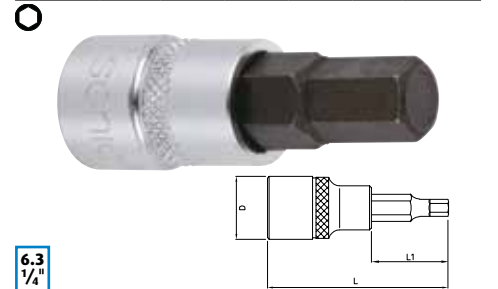

6.3
1/4"

ART. NO.	SIZE	L(MM)	L1(MM)	D(MM)	G	PCS/BAG
81413703	1/8"	37	16	12	15	10
81413704	5/32"	37	16	12	15	10
81413705	3/16"	37	16	12	15	10
81413706	7/32"	37	16	12	15	10
81413707	1/4"	37	16	12	15	10
81413708	5/16"	37	16	13	20	10
81413710	3/8"	37	16	13	25	10

BIT SOCKET HEX 3/8"

DIN NO. 3120

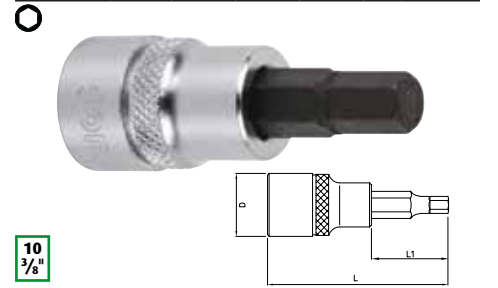

10
3/8"

ART. NO.	SIZE	L(MM)	L1(MM)	D(MM)	G	PCS/BAG
82414803	1/8"	48	20	18	35	10
82414804	5/32"	48	20	18	35	10
82414805	3/16"	48	20	18	35	10
824148055	7/32"	48	20	18	35	10
82414806	1/4"	48	20	18	35	10
82414808	5/16"	48	20	18	40	10
82414810	3/8"	48	20	18	50	10
82414812	7/16"	48	20	18	55	10
82414813	1/2"	48	20	18	60	10

BIT SOCKET HEX 1/2"

DIN NO. 3120

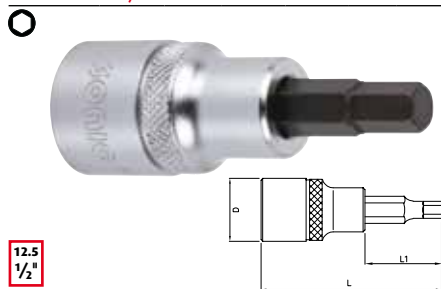

12.5
1/2"

ART. NO.	SIZE	L(MM)	L1(MM)	D(MM)	G	PCS/BAG
834106205	3/16"	62	24	22	65	10
834106206	1/4"	62	24	22	65	10
834106207	9/32"	62	24	22	70	10
834106208	5/16"	62	24	22	70	10
834106209	11/32"	62	24	22	80	10
834106210	3/8"	62	24	22	80	10
834106212	7/16"	62	24	22	85	10
834106213	1/2"	62	24	24	110	10
834106214	9/16"	62	24	24	125	10
834106217	5/8"	62	24	24	135	10

COMBINATION WRENCH

DIN NO. 3113

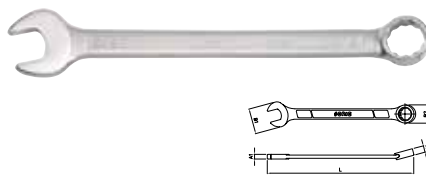

ART. NO.	SIZE	L(MM)	B1(MM)	B2(MM)	G	PCS/BAG
4150206	1/4"	105	15,5	10,1	16	10
4150208	5/16"	125	19,2	12,8	26	10
4150210	3/8"	145	23,2	15,6	40	10
4150211	7/16"	155	25,3	16,9	52	10
4150213	1/2"	175	29,4	19,7	70	10
4150214	9/16"	185	31,5	21,2	88	10
4150216	5/8"	205	34,7	24,0	114	10
4150217	11/16"	215	36,5	25,3	126	10
4150219	3/4"	235	40,7	28,1	170	10
4150221	13/16"	255	44,8	31,3	196	10
4150222	7/8"	265	46,9	32,6	218	10
4150224	15/16"	285	50,4	35,5	308	10

FLARE NUT WRENCH

DIN NO. 3118

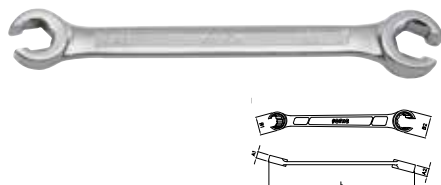

ART. NO.	SIZE	L(MM)	B1(MM)	B2(MM)	G	PCS/BAG
4250608	1/4"x5/16"	135	16,2	17,9	38	10
4251011	3/8"x7/16"	152	20,8	22,6	68	10
4251314	1/2"x9/16"	178	25,0	27,4	124	10
4251617	5/8"x11/16"	196	27,4	30,0	136	10

45° OFFSET RING WRENCH

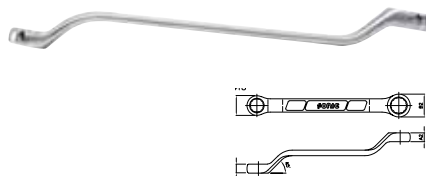

ART. NO.	SIZE	L(MM)	B1(MM)	B2(MM)	G	PCS/BAG
4270608	1/4"x5/16"	165	10,6	13,0	36	5
4271011	3/8"x7/16"	180	15,0	17,5	68	5
4271314	1/2"x9/16"	206	20,0	22,0	100	5
4271416	9/16"x5/8"	232	22,0	25,3	150	5
4271719	11/16"x3/4"	270	28,0	29,5	256	5
4272122	13/16"x7/8"	327	32,5	34,5	368	5
4272425	15/16"x1"	362	34,5	38,5	478	5

DOUBLE OPEN WRENCH

DIN NO. 3110

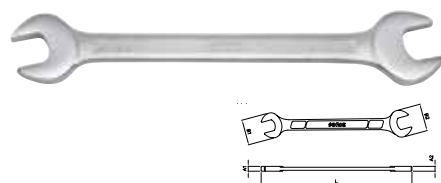

ART. NO.	SIZE	L(MM)	B1(MM)	B2(MM)	G	PCS/BAG
4220608	1/4"x5/16"	123	14,5	17,3	24	5
4221011	3/8"x7/16"	156	23,8	26,0	60	5
4221314	1/2"x9/16"	180	30,3	32,3	88	5
4221617	5/8"x11/16"	204	35,5	37,6	132	5
4221719	11/16"x3/4"	221	39,6	41,3	162	5
4222122	13/16"x7/8"	237	43,7	47,7	208	5
4222425	15/16"x1"	255	49,1	55,2	288	5
4222932	1.1/8"x1.1/4"	298	64,0	68,4	508	5



CORVETTE USA

Screwdrivers

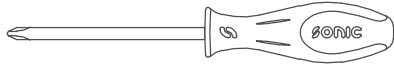

SONIC SCREWDRIVERS ARE MADE OF EXPERT QUALITY CHROME VANADIUM AND MEET OR EXCEED DIN STANDARDS. THE SONIC SCREWDRIVERS ARE DESIGNED TO OFFER A HIGH TORQUE PERFORMANCE WITHOUT SACRIFICING TOUCH OR SENSITIVITY.



EUROPEAN HANGER
+ EAN-CODE + ART. NO.



LIGHT WEIGHT
CHROME VANADIUM

SCREWDRIVER IS RESISTANT AGAINST FOLLOWING FLUIDS:

- BRAKE FLUID
- GASOLINE
- ETHYLENE GLYCOL
- MOTOR OIL
- KEROSENE
- TURPENTINE
- PETROLEUM
- ETHYL ALCOHOL
- METHYLBENZENE
- DEGREASER

FEATURES:

- LIGHT WEIGHT
- UNIQUE USER COMFORT
- HIGH TORQUE
- PERFECT ERGONOMIC GRIP DESIGN
- EFFICIENT AND FAST WORKING
- COMFORTABLE BI-MATERIAL GRIP
- EXCELLENT CONSTRUCTION
- MAGNETIC HARDENED BLACK TIPS
- 5 INDIVIDUALLY SHAPED GRIPS

12



BI-MATERIAL USER COMFORT:
RED PART PP (POLYPROPYLENE)
BLACK PART TPV (THERMOPLASTIC
VULCANIZATE)



MAGNETIC
HARDENED
BLACK TIP



UNIQUE
ERGONOMICALLY
DESIGNED GRIP



EXCELLENT USER FRIENDLY,
HIGHLY EFFECTIVE GRIP,
FOR MAXIMUM POWER



5 INDIVIDUALLY SHAPED
HANDLES TO PROVIDE
PERFECT GRIP

SONIC OFFERS A RANGE OF SCREWDRIVERS IN SLOTTED, PH, PZ, TX, TX TAMPERPROOF, HEX NUT AND HEX BALL. SONIC ALSO HAS EXTRA LONG SLOTTED AND PH SCREWDRIVERS PAGE 257



SLOTTED DIN NO ISO 2380



PH DIN NO ISO 8764



PZ DIN NO ISO 8764



TX



TX TAMPERPROOF



WORK EFFICIENT
WORK WITH SONIC

SCREWDRIVER, PH

DIN NO. ISO 8764-1 + 8764-2

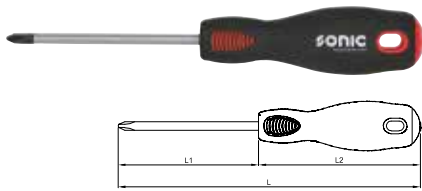

ART. NO.	SIZE	L1(MM)	L(MM)	G	PCS/BAG
1110	PH.0	60	133	20	10
1111	PH.1	80	184	62	10
1112	PH.2	100	215	94	10
1113	PH.3	150	275	156	10

HAMMER GO-THROUGH SCREWDRIVER, PH

DIN NO. ISO 8764-1 + 8764-2

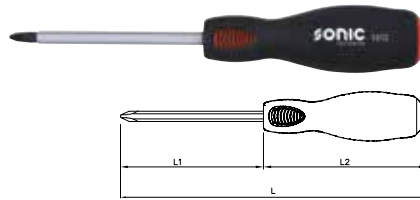

ART. NO.	SIZE	L1(MM)	L(MM)	G	PCS/BAG
1511	PH.1	75	179	80	5
1512	PH.2	100	215	134	5
1513	PH.3	150	275	202	5

SCREWDRIVER, PZ

DIN NO. ISO 8764-1 + 8764-2

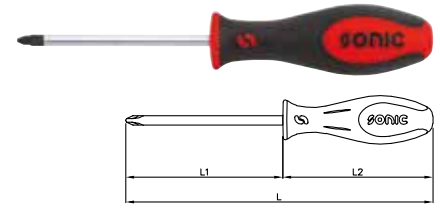

ART. NO.	SIZE	L1(MM)	L(MM)	G	PCS/BAG
1320	PZ.0	60	152	22	10
1321	PZ.1	80	183	64	10
1322	PZ.2	100	215	96	10
1323	PZ.3	150	274	158	5

SCREWDRIVER, PH

DIN NO. ISO 8764-1 + 8764-2

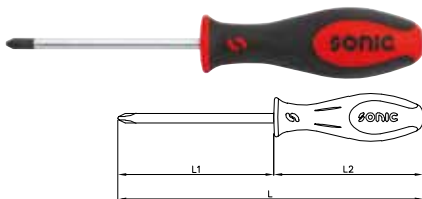

ART. NO.	SIZE	L1(MM)	L(MM)	G	PCS/BAG
1310	PH.0	60	152	20	10
1311	PH.1	80	183	62	10
1312	PH.2	100	215	94	10
1313	PH.3	150	274	156	10

HAMMER GO-THROUGH SCREWDRIVER, PH

DIN NO. ISO 8764-1 + 8764-2

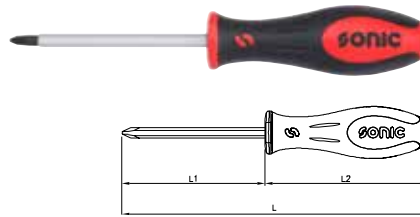

ART. NO.	SIZE	L1(MM)	L(MM)	G	PCS/BAG
15101	PH.1	75	179	84	5
15102	PH.2	100	215	138	5
15103	PH.3	150	275	214	5

SCREWDRIVER, STUBBY PZ

DIN NO. ISO 8764-1 + 8764-2

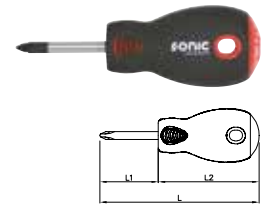

ART. NO.	SIZE	L1(MM)	L(MM)	G	PCS/BAG
1121S	PZ.1	38	103	42	10
1122S	PZ.2	38	103	48	10

SCREWDRIVER, STUBBY PH

DIN NO. ISO 8764-1 + 8764-2

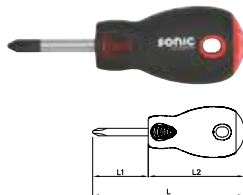

ART. NO.	SIZE	L1(MM)	L(MM)	G	PCS/BAG
1111S	PH.1	38	103	44	10
1112S	PH.2	38	103	48	10

VDE SCREWDRIVER, PH

DIN NO. ISO 8764 + EN 60900

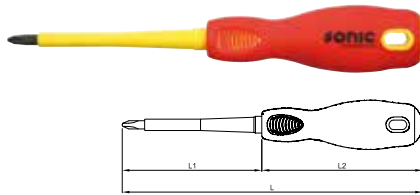

ART. NO.	SIZE	L1(MM)	L(MM)	G	PCS/BAG
1610	PH.0	60	133	20	5
1611	PH.1	80	184	62	5
1612	PH.2	100	215	94	5

SCREWDRIVER, STUBBY PZ

DIN NO. ISO 8764-1 + 8764-2

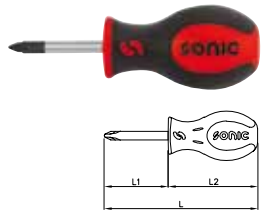

ART. NO.	SIZE	L1(MM)	L(MM)	G	PCS/BAG
1321S	PZ.1	38	104	42	10
1322S	PZ.2	38	104	48	10

SCREWDRIVER, STUBBY PH

DIN NO. ISO 8764-1 + 8764-2

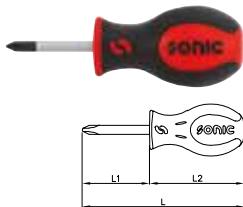

ART. NO.	SIZE	L1(MM)	L(MM)	G	PCS/BAG
1311S	PH.1	38	104	44	10
1312S	PH.2	38	104	48	10

SCREWDRIVER, PZ

DIN NO. ISO 8764-1 + 8764-2

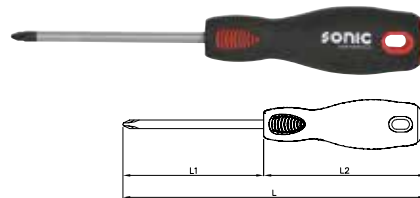

ART. NO.	SIZE	L1(MM)	L(MM)	G	PCS/BAG
1120	PZ.0	60	133	22	10
1121	PZ.1	80	184	64	10
1122	PZ.2	100	215	96	10
1123	PZ.3	150	275	158	5

SLOTTED SCREWDRIVER

DIN NO. ISO 2380-1 + 2380-2

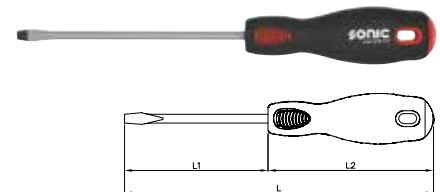

ART. NO.	SIZE	L1(MM)	L(MM)	G	PCS/BAG
11303	3	75	148	20	10
11335	3.5	100	173	24	10
11304	4	100	173	28	10
11355	5.5	125	229	72	10
11365	6.5	150	265	104	10
11308	8	175	300	164	10
11310	10	200	324	228	10
11312	12	200	324	238	10

SLOTTED SCREWDRIVER DIN NO. ISO 2380-1 + 2380-2

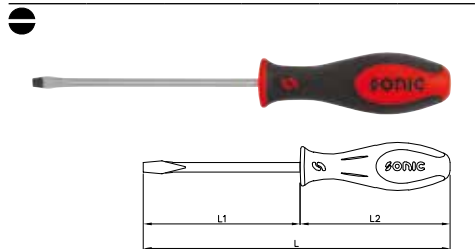

ART. NO.	SIZE	L1(MM)	L(MM)	G	PCS/BAG
13303	3	75	167	20	10
13335	3.5	100	192	24	10
13304	4	100	192	28	10
13355	5.5	125	228	72	10
13365	6.5	150	265	104	10
13308	8	175	299	164	10
13310	10	200	324	228	10
13312	12	200	324	238	10

SLOTTED SCREWDRIVER DIN NO. ISO 2380-1 + 2380-2

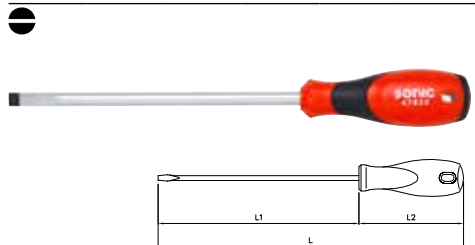

ART. NO.	SIZE	L1(MM)	L(MM)	G	PCS/BAG
47822	10	315	200	162	10
47823	12	315	200	162	10

SLOTTED STUBBY SCREWDRIVER DIN NO. ISO 2380-1 + 2380-2

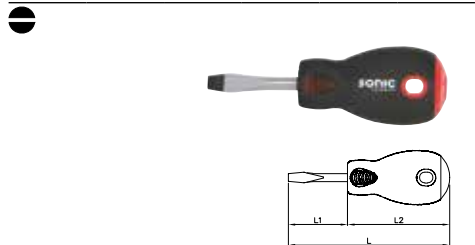

ART. NO.	SIZE	L1(MM)	L(MM)	G	PCS/BAG
1130555	5.5	38	103	44	10
1130655	6.5	38	103	48	10

SLOTTED STUBBY SCREWDRIVER DIN NO. ISO 2380-1 + 2380-2

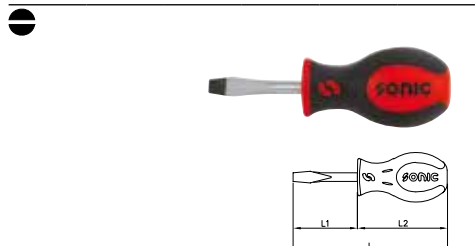

ART. NO.	SIZE	L1(MM)	L(MM)	G	PCS/BAG
1330555	5.5	38	104	44	10
1330655	6.5	38	104	48	10

HAMMER GO-THROUGH SLOTTED SCREWDRIVER DIN NO. ISO 2380-1 + 2380-2

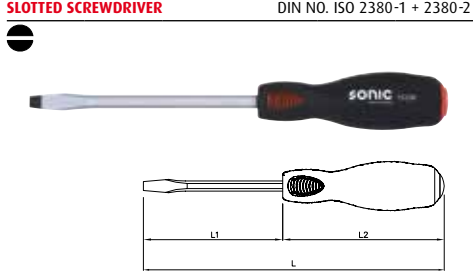

ART. NO.	SIZE	L1(MM)	L(MM)	G	PCS/BAG
15355	5.5	100	204	84	5
15365	6.5	125	240	140	5
15308	8	150	275	202	5

HAMMER GO-THROUGH SLOTTED SCREWDRIVER DIN NO. ISO 2380-1 + 2380-2



ART. NO.	SIZE	L1(MM)	L(MM)	G	PCS/BAG
1530155	5.5	100	204	88	5
1530165	6.5	125	240	144	5
1530108	8	150	275	208	5

VDE SLOTTED SCREWDRIVER DIN NO. ISO 2380 + EN 60900

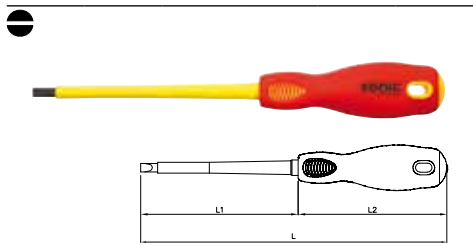

ART. NO.	SIZE	L1(MM)	L(MM)	G	PCS/BAG
16325	2.5	75	148	20	5
16304	4	100	204	62	5
16355	5.5	125	229	78	5
16365	6.5	150	265	116	5

ELECTRONIC SCREWDRIVER

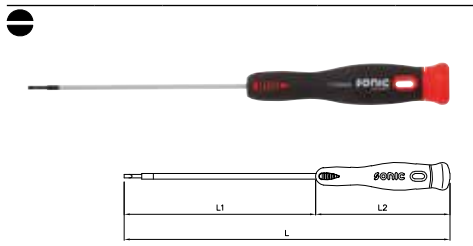

ART. NO.	SIZE	L1(MM)	L(MM)	G	PCS/BAG
17320002	2	100	192	20	10

MULTIFUNCTIONAL AC/DC VOLTAGE TESTER DIN NO. ISO 8764-1 + 8764-2

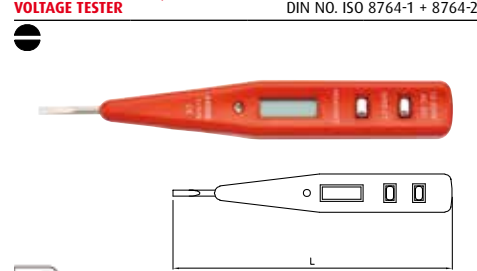

ART. NO.	L(MM)	G	PCS/BAG
47016	133	20	5

SCREWDRIVER LONG DIN NO. ISO 2380-1 + 2380-2

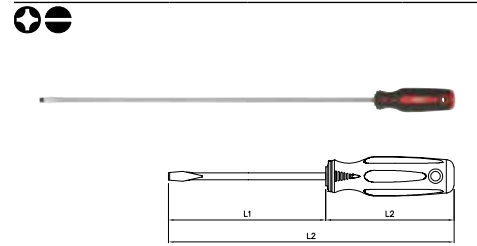

ART. NO.	SIZE	L1(MM)	L(MM)	G	PCS/BAG
1114502	PH.2	450	559	200	5
11345065	6.5	450	559	198	5
11360008	8	600	719	360	5

SCREWDRIVER, TX

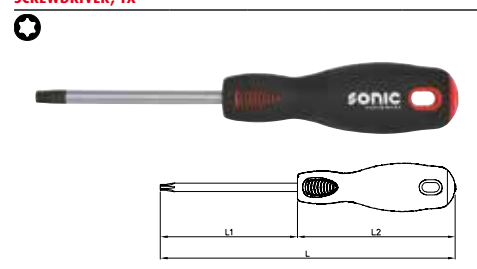

ART. NO.	SIZE	L1(MM)	L(MM)	G	PCS/BAG
11605	T5	75	148	24	10
11606	T6	75	148	24	10
11607	T7	75	148	24	10
11608	T8	75	148	24	10
11609	T9	75	148	26	10
11610	T10	100	204	64	10
11615	T15	100	204	66	10
11620	T20	100	204	68	10
11625	T25	100	215	94	10
11627	T27	100	215	94	10
11630	T30	100	215	94	10
11640	T40	100	215	102	10
11645	T45	100	225	136	10

SCREWDRIVER, TX

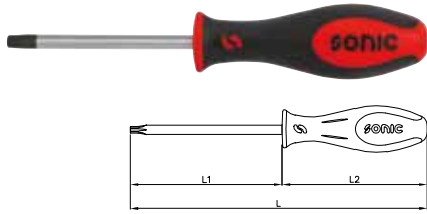

ART. NO.	SIZE	L1 (MM)	L (MM)	N.W. (G)	PCS/BAG
13605	T5	75	167	24	10
13606	T6	75	167	24	10
13607	T7	75	167	24	10
13608	T8	75	167	24	10
13609	T9	75	167	26	10
13610	T10	100	203	64	10
13615	T15	100	203	66	10
13620	T20	100	203	68	10
13625	T25	100	215	94	10
13627	T27	100	215	94	10
13630	T30	100	215	94	10
13640	T40	100	215	102	10
13645	T45	100	224	136	10

SCREWDRIVER, TX

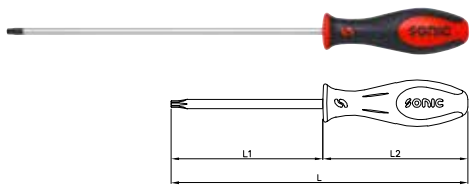

ART. NO.	SIZE	L1 (MM)	L (MM)	G	PCS/BAG
13625015	15	250	353	94	10
13625020	20	250	353	94	10
13625025	25	250	365	132	10
13625030	30	250	365	132	10
13625045	45	250	365	184	10

SCREWDRIVER, TX TAMPERPROOF

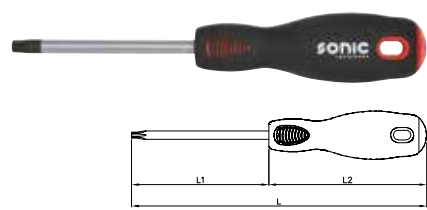

ART. NO.	SIZE	L1 (MM)	L (MM)	G	PCS/BAG
11708	T8H	75	148	24	10
11710	T10H	100	204	64	10
11715	T15H	100	204	66	10
11720	T20H	100	204	68	10
11725	T25H	100	215	94	10
11727	T27H	100	215	94	10
11730	T30H	100	215	94	10
11740	T40H	100	215	102	10

SCREWDRIVER, TX TAMPERPROOF

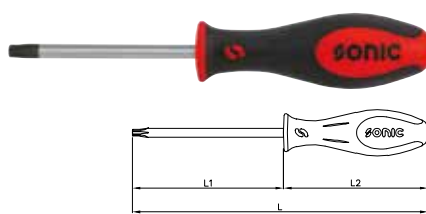

ART. NO.	SIZE	L1 (MM)	L (MM)	N.W. (G)	PCS/BAG
13708	T8H	75	167	24	10
13710	T10H	100	203	64	10
13715	T15H	100	203	66	10
13720	T20H	100	203	68	10
13725	T25H	100	215	94	10
13727	T27H	100	215	94	10
13730	T30H	100	215	94	10
13740	T40H	100	215	102	10

HEX NUT DRIVER

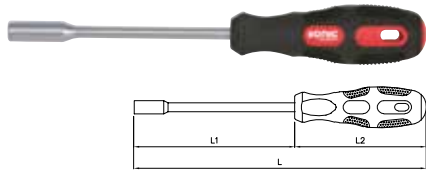

ART. NO.	SIZE	L1 (MM)	L (MM)	G	PCS/BAG
12525004	4	125	235	102	10
12525005	5	125	235	106	10
125250055	5.5	125	235	108	10
12525006	6	125	235	110	10
12525008	8	125	235	118	10
12525009	9	125	235	118	10
12525010	10	125	235	122	10
12525011	11	125	247	162	10
12525012	12	125	247	166	10
12525013	13	125	247	168	10

HEX NUT DRIVER

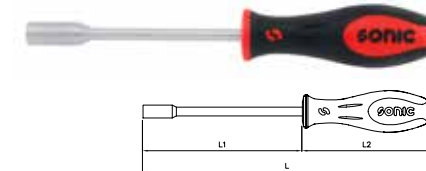

ART. NO.	SIZE	L1 (MM)	L (MM)	G	PCS/BAG
12425004	4	125	240	115	10
12425005	5	125	240	119	10
124250055	5.5	125	240	121	10
12425006	6	125	240	123	10
12425008	8	125	240	131	10
12425009	9	125	240	131	10
12425010	10	125	240	135	10
12425011	11	125	249	167	10
12425012	12	125	249	171	10
12425013	13	125	249	173	10

FLEXIBLE HEX NUT DRIVER

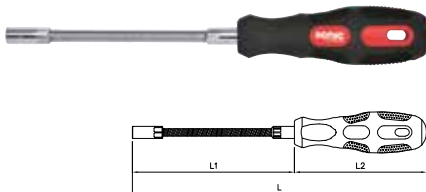

ART. NO.	SIZE	L1 (MM)	L (MM)	G	PCS/BAG
47506	6	150	272	146	10
47507	7	150	272	146	10
47508	8	150	272	146	10

FLEXIBLE HEX NUT DRIVER

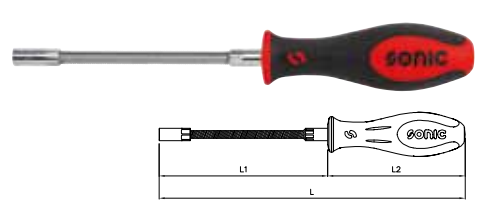

ART. NO.	SIZE	L1 (MM)	L (MM)	G	PCS/BAG
47536	6	150	274	151	10
47537	7	150	274	151	10
47538	8	150	274	151	10

HEX NUT DRIVER T-HANDLE

DIN NO. ISO 3125

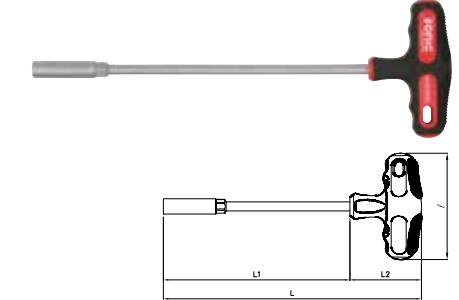

ART. NO.	SIZE	L1 (MM)	L (MM)	G	PCS/BAG
14523005	5	230	287	112	5
14523006	6	230	287	134	5
14523007	7	230	287	150	5
14523008	8	230	287	148	5
14523009	9	230	287	152	5
14523010	10	230	287	158	5
14523011	11	230	287	190	5
14523012	12	230	287	196	5
14523013	13	230	287	198	5

HEX NUT DRIVER T-HANDLE

DIN NO. ISO 3125

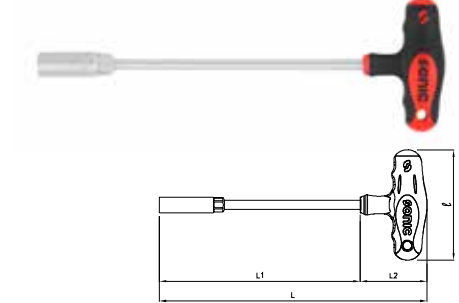

ART. NO.	SIZE	L1 (MM)	L (MM)	G	PCS/BAG
14423005	5	230	287	112	5
14423006	6	230	287	136	5
14423007	7	230	287	146	5
14423008	8	230	287	148	5
14423009	9	230	287	150	5
14423010	10	230	287	156	5
14423011	11	230	287	188	5
14423012	12	230	287	192	5
14423013	13	230	287	196	5

HEX BALL POINT GRIP KEY

DIN NO. ISO 2936

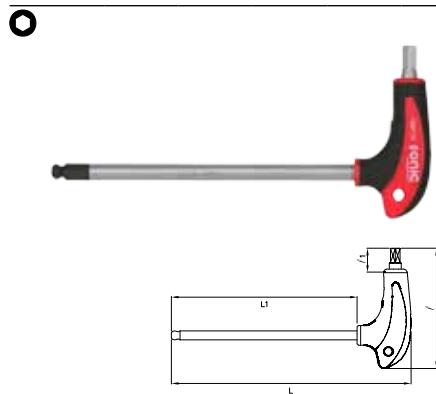

ART. NO.	SIZE	L1(MM)	L(MM)	G	PCS/BAG
1950102	2	110	140	20	10
19501025	2.5	110	140	22	10
1950103	3	110	140	26	10
1950104	4	110	140	38	10
1950105	5	160	204	86	10
1950106	6	160	204	106	10
1950107	7	160	204	126	10
1950108	8	200	245	186	10
1950110	10	215	270	342	10
1950112	12	215	270	440	10

STAR GRIP KEY

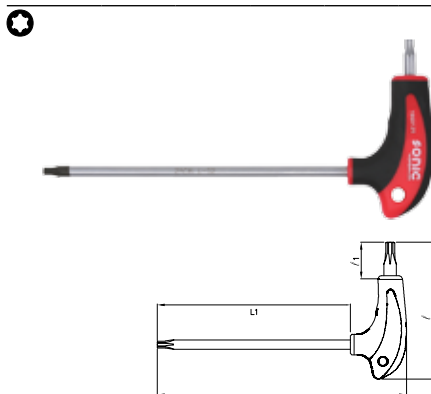

ART. NO.	SIZE	L1(MM)	L(MM)	G	PCS/BAG
1960108	T8	110	140	28	10
1960110	T10	110	140	30	10
1960115	T15	110	140	30	10
1960120	T20	110	140	30	10
1960125	T25	160	204	86	10
1960127	T27	160	204	86	10
1960130	T30	160	204	86	10
1960140	T40	185	231	114	10
1960145	T45	215	270	190	10
1960150	T50	215	270	240	10

16 IN 1 RATCHET SCREWDRIVER

SGO



ART. NO.	CONTENTS	PCS
601001-1	RATCHET GRIP	1
601001-2	BIT HOLDER	1
601001-3	BIT PH.1 + PH.2	1
601001-4	BIT PZ.1 + PZ.2	1
601001-5	BIT SLOTTED 3.5MM + 5MM	1
601001-6	BIT 1/4" DRIVER	1
601001-7	BIT T10 + T15	1
601001-8	BIT T20 + T25	1
601001-9	BIT T27 + T30	1
601001-10	BIT HEX 3MM + 4MM	1

HEX BALL POINT GRIP KEY

DIN NR. ISO 2936

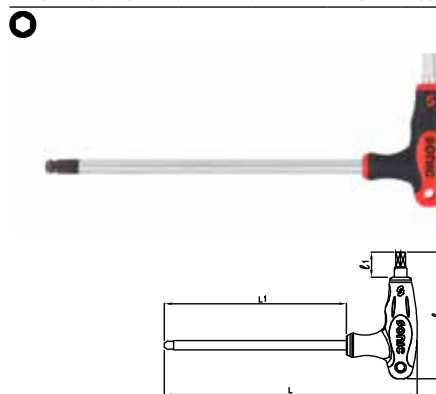

ART. NO.	SIZE	L1(MM)	L(MM)	G	PCS/BAG
1950202	2	103	142	18	10
19502025	2.5	103	142	20	10
1950203	3	103	142	24	10
1950204	4	103	142	36	10
1950205	5	153	206	80	10
1950206	6	153	206	100	10
1950207	7	153	206	120	10
1950208	8	193	246	178	10
1950210	10	200	270	336	10
1950212	12	200	270	434	10

STAR GRIP KEY

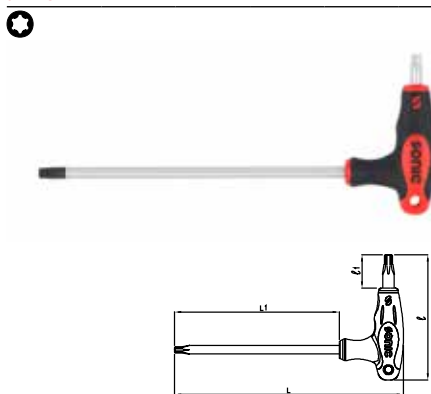

ART. NO.	SIZE	L1(MM)	L(MM)	G	PCS/BAG
1960208	T8	103	142	26	10
1960210	T10	103	142	28	10
1960215	T15	103	142	28	10
1960220	T20	103	142	28	10
1960225	T25	153	206	80	10
1960227	T27	153	206	80	10
1960230	T30	153	206	80	10
1960240	T40	178	231	106	10
1960245	T45	200	270	188	10
1960250	T50	200	270	236	10

SCREWDRIVER TRY ME



ART. NO.	L(MM)	D1(MM)	D2(MM)	W(MM)	G	PCS/BAG
47828	335	40,5	29	40,5	220	1

FOR MORE SCREWDRIVERS SEE:

GENERAL TOOL SCREWDRIVERS
PAGE 161

SONIC FOAM SYSTEM
PAGE 121

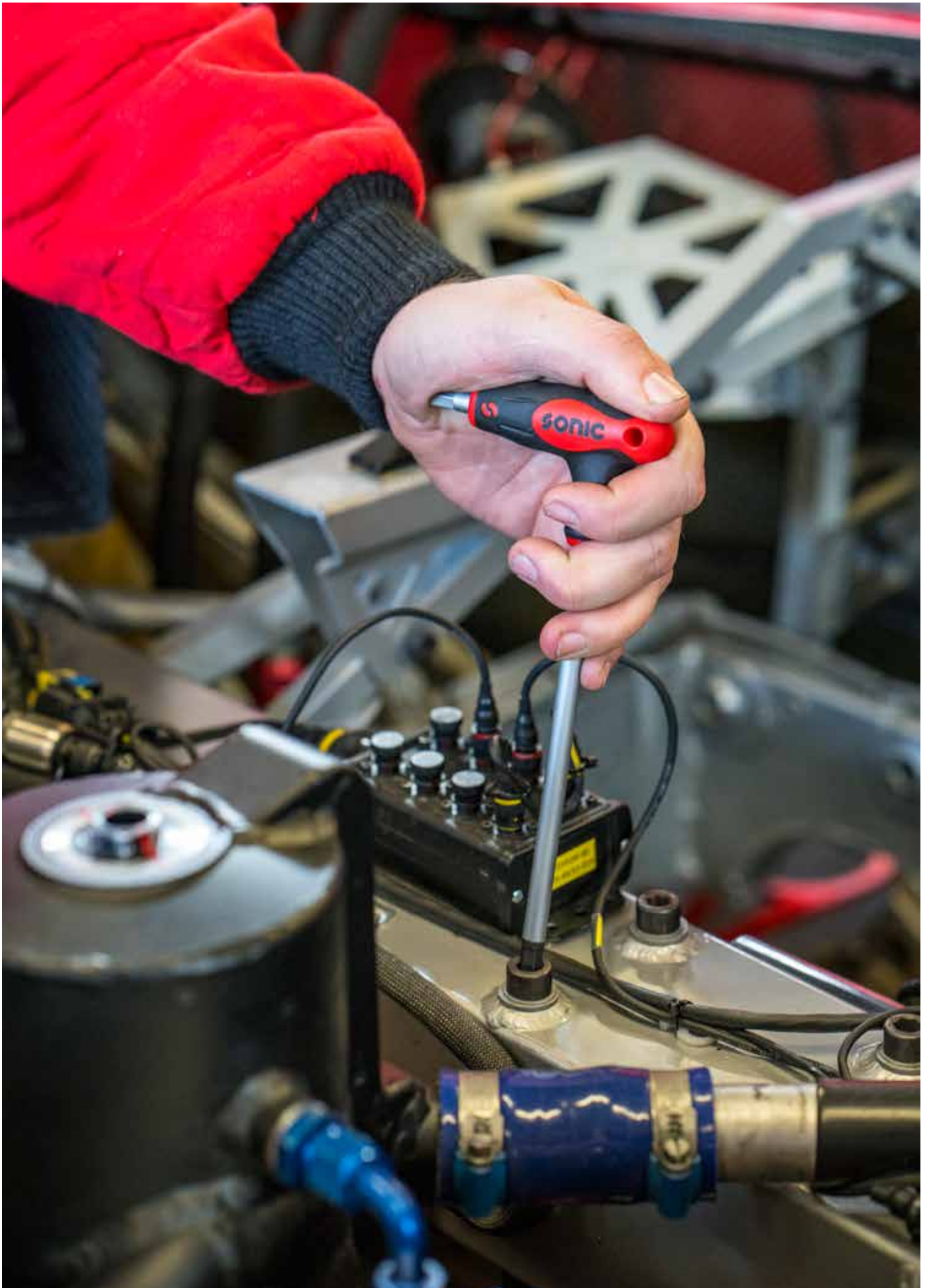

Sockets

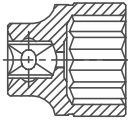

THE SONIC SOCKETS HAVE THE ABILITY TO BRING STRENGTH ONTO THE BOLTS AND NUTS DUE TO ITS OUTSTANDING GRIP ON THE FLANKS, WITHOUT DOING DAMAGE TO ANY OF THE MATERIAL. THE POSSIBILITY TO DAMAGE THE EDGES OF BOLTS IS NO LONGER AN ISSUE.



- SELECT THE PROPER TYPE OF SOCKET FOR THE APPLICATION
- ALL CHROME PLATED SOCKETS ARE FOR HAND USE ONLY
- DO NOT USE CHROME PLATED HAND TOOLS WITH IMPACT DRIVERS
- USE MODERATE FORCE ON SOCKETS TO AVOID DAMAGE ON FASTENERS
- DO NOT USE DAMAGED TOOLS
- BE PROPERLY TRAINED
- MISUSE OR BROKEN TOOLS CAN CAUSE INJURY

DRIVE	SIZE IN MM	SIZE IN SAE	SIZE IN TX
6.3 1/4"	3MM - 14MM	3/16" - 1/2"	E4 - E10
10 3/8"	6MM - 24MM	3/8" - 13/16"	E4 - E20
12.5 1/2"	8MM - 32MM	3/8" - 1.1/4"	E10 - E24
20 3/4"	17MM - 60MM	3/4" - 2"	
25 1"	35MM - 80MM		



SLIM FIT



KNURLED TO IMPROVE ANTI SLIP



DIRECT FIT



INDUSTRIAL INTERNAL FINISHMENT



MINIMUM TOLERANCE



ERGONOMIC SHAPE

13

A VARIETY OF SONIC SOCKETS



1/4" DR. FLANK DEEP SOCKET

6.3
1/4"



3/8" DR. TX SOCKET

10
3/8"



1/2" DR. FLANK DEEP SOCKET

12.5
1/2"



3/4" DR. SOCKET

20
3/4"



1/2" DR. IMPACT DEEP SOCKET

12.5
1/2"

WORK EFFICIENT
WORK WITH SONIC

FLANK SOCKET 1/4", 6 PT.

DIN NO. 3120/3124

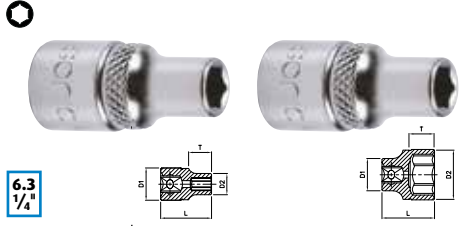

6.3
1/4"

ART. NO.	SIZE	L(MM)	D2(MM)	G	PCS/BAG
21503	3	25,0	6,0	10	10
21504	4	25,0	6,8	10	10
21545	4.5	25,0	7,2	10	10
21505	5	25,0	7,8	10	10
21555	5.5	25,0	8,4	10	10
21506	6	25,0	9,3	10	10
21507	7	25,0	11,0	12	10
21508	8	25,0	12,0	10	10
21509	9	25,0	13,0	12	10
21510	10	25,0	15,0	12	10
21511	11	25,0	16,0	16	10
21512	12	25,0	17,0	18	10
21513	13	25,0	18,0	18	10
21514	14	25,0	19,0	26	10

FLANK SOCKET 1/4", 6 PT. DEEP

DIN NO. 3120/3124

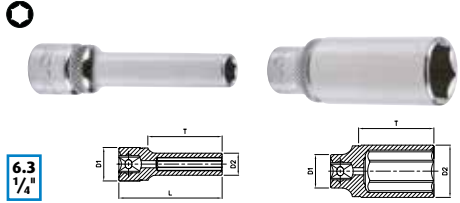

6.3
1/4"

ART. NO.	SIZE	L(MM)	D2(MM)	G	PCS/BAG
2155004	4	50,0	6,8	16	10
21550045	4.5	50,0	7,2	16	10
2155005	5	50,0	7,8	16	10
21550055	5.5	50,0	8,4	14	10
2155006	6	50,0	9,3	18	10
2155007	7	50,0	11,0	22	10
2155008	8	50,0	12,0	22	10
2155009	9	50,0	13,0	28	10
2155010	10	50,0	15,0	32	10
2155011	11	50,0	16,0	38	10
2155012	12	50,0	17,0	42	10
2155013	13	50,0	18,0	46	10

SOCKET 1/4", 12 PT.

DIN NO. 3120

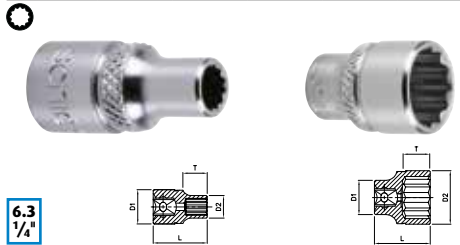

6.3
1/4"

ART. NO.	SIZE	L(MM)	D2(MM)	G	PCS/BAG
21804	4	25,0	6,8	10	10
21845	4.5	25,0	7,2	10	10
21805	5	25,0	7,8	10	10
21855	5.5	25,0	8,4	10	10
21806	6	25,0	9,3	10	10
21807	7	25,0	11,0	12	10
21808	8	25,0	12,0	10	10
21809	9	25,0	13,0	12	10
21810	10	25,0	15,0	12	10
21811	11	25,0	16,0	16	10
21812	12	25,0	17,0	18	10
21813	13	25,0	18,0	18	10

SOCKET 1/4", 12 PT. DEEP

DIN NO. 3120

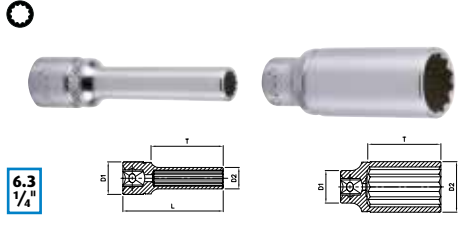

6.3
1/4"

ART. NO.	SIZE	L(MM)	D2(MM)	G	PCS/BAG
2185004	4	50,0	6,8	16	10
21850045	4.5	50,0	7,2	16	10
2185005	5	50,0	7,8	16	10
21850055	5.5	50,0	8,4	14	10
2185006	6	50,0	9,3	18	10
2185007	7	50,0	11,0	22	10
2185008	8	50,0	12,0	22	10
2185009	9	50,0	13,0	28	10
2185010	10	50,0	15,0	32	10
2185011	11	50,0	16,0	38	10
2185012	12	50,0	17,0	42	10
2185013	13	50,0	18,0	46	10

SOCKET 1/4", 12 PT. SAE

DIN NO. 3120

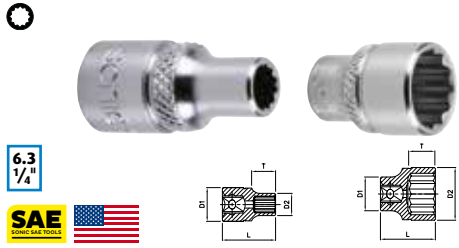

6.3
1/4"



ART. NO.	SIZE	L(MM)	D2(MM)	G	PCS/BAG
21905	3/16"	25,0	7,8	10	10
21955	7/32"	25,0	8,4	10	10
21906	1/4"	25,0	9,3	10	10
21907	9/32"	25,0	11,0	10	10
21908	5/16"	25,0	12,0	10	10
21909	11/32"	25,0	13,0	10	10
21910	3/8"	25,0	14,0	10	10
21911	7/16"	25,0	16,0	15	10
21913	1/2"	25,0	18,0	20	10

SOCKET 1/4", 12 PT. DEEP SAE

DIN NO. 3120

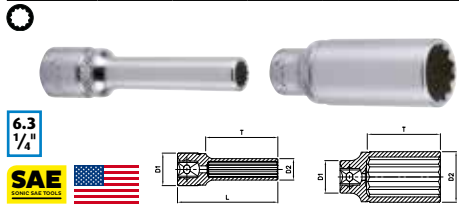

6.3
1/4"



ART. NO.	SIZE	L(MM)	D2(MM)	G	PCS/BAG
2195005	3/16"	50,0	7,2	15	10
21950055	7/32"	50,0	8,4	15	10
2195006	1/4"	50,0	9,3	20	10
2195007	9/32"	50,0	11,0	20	10
2195008	5/16"	50,0	12,0	20	10
2195009	11/32"	50,0	13,0	25	10
2195010	3/8"	50,0	14,0	30	10
2195011	7/16"	50,0	16,0	35	10
2195012	1/2"	50,0	18,0	45	10

SOCKET 1/4", TX

DIN NO. 3120

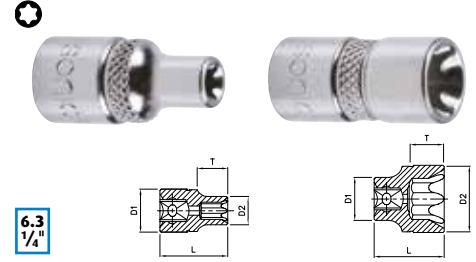

6.3
1/4"

ART. NO.	SIZE	L(MM)	D2(MM)	G	PCS/BAG
21604	E4	25,0	6,0	10	10
21605	E5	25,0	7,0	10	10
21606	E6	25,0	8,0	10	10
21607	E7	25,0	9,0	10	10
21608	E8	25,0	10,0	10	10
21610	E10	25,0	11,5	12	10

SOCKET 1/4", TX DEEP

DIN NO. 3120

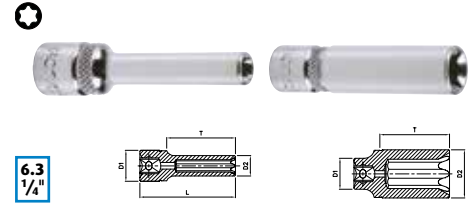

6.3
1/4"

ART. NO.	SIZE	L(MM)	D2(MM)	G	PCS/BAG
2165004	E4	50,0	6,0	14	10
2165005	E5	50,0	7,0	16	10
2165006	E6	50,0	8,0	18	10
2165007	E7	50,0	9,0	18	10
2165008	E8	50,0	10,0	20	10
2165010	E10	50,0	11,5	26	10

CARDAN SOCKET 1/4", 12PT.

DIN NO. 3120

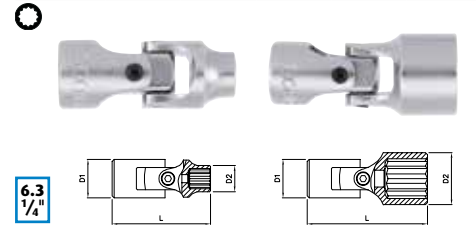

6.3
1/4"

ART. NO.	SIZE	L(MM)	D2(MM)	G	PCS/BAG
7151806	6	35,0	9,2	22	10
7151807	7	35,0	10,5	22	10
7151808	8	36,5	11,7	22	10
7151809	9	36,5	13,0	22	10
7151810	10	38,5	13,8	24	10
7151811	11	39,5	15,6	26	10
7151812	12	40,0	16,7	26	10
7151813	13	40,0	18,0	28	10

CARDAN SOCKET 1/4", TX

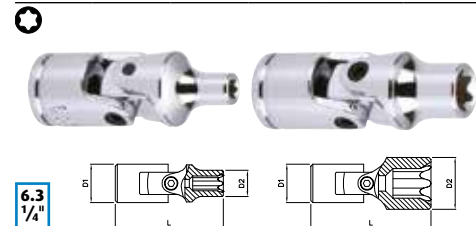

6.3
1/4"

ART. NO.	SIZE	L(MM)	D2(MM)	G	PCS/BAG
7151604	E4	40,0	6,0	24	10
7151605	E5	40,0	6,8	24	10
7151606	E6	40,0	7,8	26	10
7151607	E7	40,0	8,8	26	10
7151608	E8	40,0	9,8	26	10

FLANK SOCKET 3/8", 6 PT.

DIN NO. 3120/3124

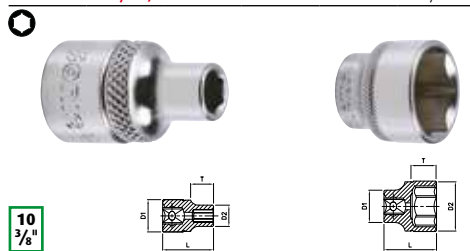

ART. NO.	SIZE	L(MM)	D2(MM)	G	PCS/BAG
22506	6	28,0	9,3	20	10
22507	7	28,0	10,6	22	10
22508	8	28,0	11,8	22	10
22509	9	28,0	13,2	22	10
22510	10	28,0	14,5	22	10
22511	11	28,0	15,7	24	10
22512	12	28,0	17,0	22	10
22513	13	28,0	18,0	24	10
22514	14	28,0	20,0	28	10
22515	15	28,0	22,0	34	10
22516	16	28,0	22,0	32	10
22517	17	30,0	24,0	40	10
22518	18	30,0	26,0	42	10
22519	19	30,0	26,0	46	10
22520	20	30,0	28,0	60	10
22521	21	30,0	28,0	50	10
22522	22	32,0	30,0	60	10
22524	24	32,0	32,0	62	10

SOCKET 3/8", 12 PT.

DIN NO. 3120

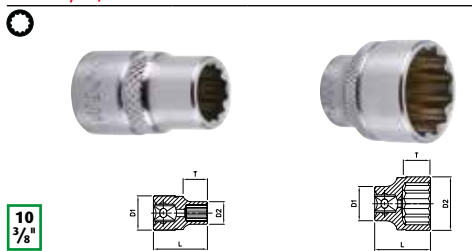

ART. NO.	SIZE	L(MM)	D2(MM)	G	PCS/BAG
22806	6	28,0	9,3	20	10
22807	7	28,0	10,6	22	10
22808	8	28,0	11,8	22	10
22809	9	28,0	13,2	22	10
22810	10	28,0	14,5	22	10
22811	11	28,0	15,7	24	10
22812	12	28,0	17,0	22	10
22813	13	28,0	18,0	24	10
22814	14	28,0	20,0	28	10
22815	15	28,0	22,0	34	10
22816	16	28,0	22,0	32	10
22817	17	30,0	24,0	40	10
22818	18	30,0	26,0	42	10
22819	19	30,0	26,0	46	10
22820	20	30,0	28,0	60	10
22821	21	30,0	28,0	50	10
22822	22	32,0	30,0	60	10
22824	24	32,0	32,0	62	10

SOCKET 3/8", 12 PT. SAE

DIN NO. 3120

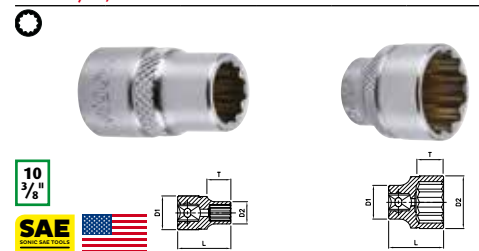

ART. NO.	SIZE	L(MM)	D2(MM)	G	PCS/BAG
22906	1/4"	28,0	9,3	20	10
22908	5/16"	28,0	11,8	20	10
22910	3/8"	28,0	14,5	20	10
22911	7/16"	28,0	15,7	20	10
22913	1/2"	28,0	18,0	25	10
22914	9/16"	28,0	20,0	25	10
22916	5/8"	28,0	22,0	30	10
22917	11/16"	30,0	24,0	35	10
22919	3/4"	30,0	26,0	45	10
22921	13/16"	30,0	28,0	50	10

FLANK SOCKET 3/8", 6 PT. DEEP

DIN NO. 3120/3124

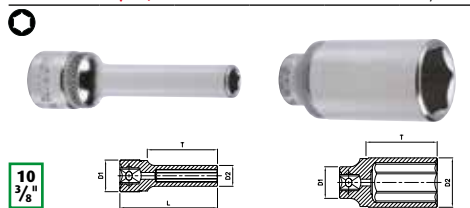

ART. NO.	SIZE	L(MM)	D2(MM)	G	PCS/BAG
2256306	6	63,0	9,3	34	10
2256307	7	63,0	10,6	36	10
2256308	8	63,0	11,8	34	10
2256309	9	63,0	13,2	44	10
2256310	10	63,0	14,5	46	10
2256311	11	63,0	15,7	50	10
2256312	12	63,0	18,0	62	10
2256313	13	63,0	19,0	68	10
2256314	14	63,0	20,0	74	10
2256315	15	63,0	22,0	96	10
2256316	16	63,0	22,0	82	10
2256317	17	63,0	24,0	106	10
2256318	18	63,0	26,0	130	10
2256319	19	63,0	26,0	116	10
2256320	20	63,0	28,0	148	10
2256321	21	63,0	28,0	126	10
2256322	22	63,0	30,0	160	10

FLANK SOCKET 3/8", 12 PT. DEEP

DIN NO. 3120

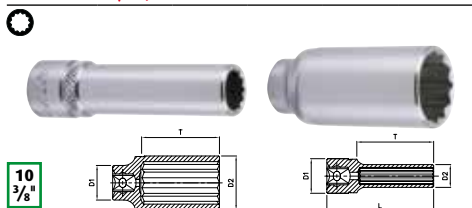

ART. NO.	SIZE	L(MM)	D2(MM)	G	PCS/BAG
2286306	6	63,0	9,3	34	10
2286307	7	63,0	10,6	36	10
2286308	8	63,0	11,8	34	10
2286309	9	63,0	13,2	44	10
2286310	10	63,0	14,5	46	10
2286311	11	63,0	15,7	50	10
2286312	12	63,0	18,0	62	10
2286313	13	63,0	19,0	68	10
2286314	14	63,0	20,0	74	10
2286315	15	63,0	22,0	96	10
2286316	16	63,0	22,0	82	10
2286317	17	63,0	24,0	106	10
2286318	18	63,0	26,0	130	10
2286319	19	63,0	26,0	116	10
2286320	20	63,0	28,0	148	10
2286321	21	63,0	28,0	126	10
2286322	22	63,0	30,0	160	10
2286324	24	63,0	32,0	210	10

SOCKET 3/8", 12 PT. DEEP SAE

DIN NO. 3120

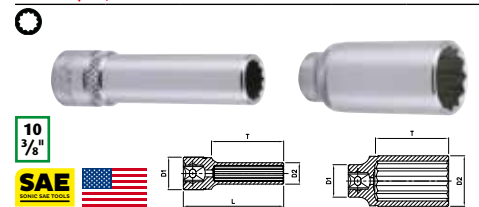

ART. NO.	SIZE	L(MM)	D2(MM)	G	PCS/BAG
2296306	1/4"	63,0	11,4	42	10
2296308	5/16"	63,0	12,4	44	10
2296310	3/8"	63,0	14,5	45	10
2296311	7/16"	63,0	15,7	50	10
2296313	1/2"	63,0	18,0	65	10
2296314	9/16"	63,0	20,0	70	10
2296316	5/8"	63,0	22,0	85	10
2296317	11/16"	63,0	24,0	100	10
2296319	3/4"	63,0	26,0	115	10
2296321	13/16"	63,0	28,0	130	10

SOCKET 3/8", TX

DIN NO. 3120

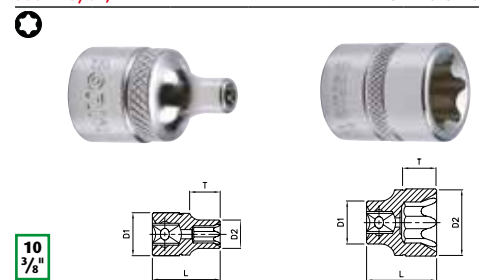

ART. NO.	SIZE	L(MM)	D2(MM)	G	PCS/BAG
22604	E4	28,0	6,0	20	10
22605	E5	28,0	7,0	22	10
22606	E6	28,0	8,0	20	10
22607	E7	28,0	9,0	22	10
22608	E8	28,0	10,0	22	10
22610	E10	28,0	12,0	22	10
22611	E11	28,0	13,0	24	10
22612	E12	28,0	14,0	24	10
22614	E14	28,0	16,0	24	10
22616	E16	28,0	18,0	28	10
22618	E18	28,0	20,0	58	10
22620	E20	30,0	22,0	72	10

SOCKET 3/8", TX DEEP

DIN NO. 3120

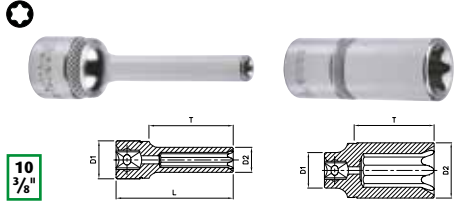

10
3/8"

ART. NO.	SIZE	L(MM)	D2(MM)	G	PCS/BAG
2266304	E4	63,0	6,0	26	10
2266305	E5	63,0	7,0	28	10
2266306	E6	63,0	8,0	34	10
2266307	E7	63,0	9,0	32	10
2266308	E8	63,0	10,0	38	10
2266310	E10	63,0	12,0	42	10
2266311	E11	63,0	13,0	42	10
2266312	E12	63,0	14,0	50	10
2266314	E14	63,0	16,0	64	10
2266316	E16	63,0	18,0	68	10
2266318	E18	63,0	20,0	129	10
2266320	E20	63,0	24,0	151	10

CARDAN SOCKET 3/8"

DIN NO. 3120

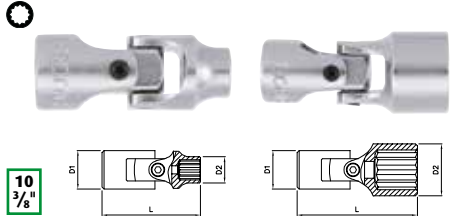

10
3/8"

ART. NO.	SIZE	L(MM)	D2(MM)	G	PCS/BAG
7152810	10	49,5	14,5	60	10
7152811	11	50,5	15,8	60	10
7152812	12	51,0	17,0	60	10
7152813	13	52,0	18,3	60	10
7152814	14	52,0	20,0	60	10
7152815	15	54,5	22,0	65	10
7152816	16	54,5	22,0	65	10
7152817	17	55,5	24,0	70	10
7152818	18	55,5	26,0	70	10
7152819	19	57,5	26,0	75	10

CARDAN SOCKET 3/8", TX

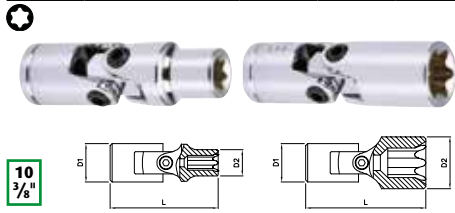

10
3/8"

ART. NO.	SIZE	L(MM)	D2(MM)	G	PCS/BAG
7152610	E10	60,0	13,8	66	10
7152612	E12	61,0	14,6	68	10
7152614	E14	61,0	16,7	72	10
7152616	E16	61,0	18,5	76	10

GLOW PLUG SOCKET 3/8", 72MML

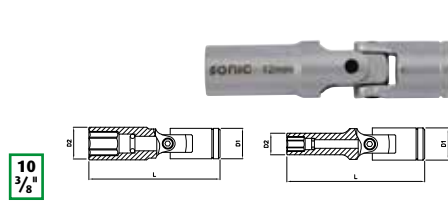

10
3/8"

ART. NO.	SIZE	L(MM)	D2(MM)	G	PCS/BAG
7176208	8	72	12	64	10
7176209	9	72	13	70	10
7176210	10	72	14	72	10
7176212	12	72	16	72	10
7176214	14	80	18	82	10
7176216	16	80	20	94	10

FLANK SOCKET 1/2", 6 PT.

DIN NO. 3120/3124

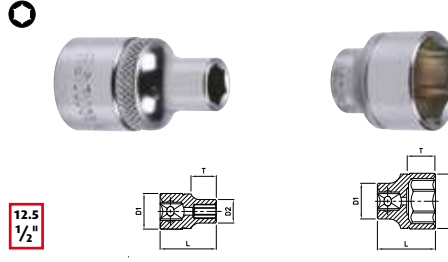

12.5
1/2"

ART. NO.	SIZE	L(MM)	D2(MM)	G	PCS/BAG
23508	8	38,0	12,2	46	10
23509	9	38,0	13,5	48	10
23510	10	38,0	15,0	48	10
23511	11	38,0	16,3	50	10
23512	12	38,0	17,6	50	10
23513	13	38,0	18,8	52	10
23514	14	38,0	20,4	54	10
23515	15	38,0	21,0	52	10
23516	16	38,0	22,0	48	10
23517	17	38,0	24,0	60	10
23518	18	38,0	26,0	70	10
23519	19	38,0	26,0	58	10
23520	20	38,0	28,0	70	10
23521	21	38,0	28,0	60	10
23522	22	38,0	30,0	88	10
23523	23	38,0	32,0	98	10
23524	24	38,0	32,0	90	10
23525	25	42,0	34,0	118	10
23526	26	42,0	36,0	142	10
23527	27	42,0	36,0	136	10
23528	28	43,0	38,0	154	10
23529	29	43,0	38,0	134	10
23530	30	43,0	40,0	158	10
23532	32	43,0	42,0	168	10

FLANK SOCKET 1/2", 6 PT. DEEP

DIN NO. 3120/3124

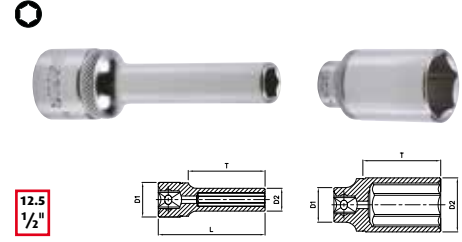

12.5
1/2"

ART. NO.	SIZE	L(MM)	D2(MM)	G	PCS/BAG
2357708	8	77,0	12,2	70	10
2357709	9	77,0	13,5	74	10
2357710	10	77,0	15,0	66	10
2357711	11	77,0	16,3	78	10
2357712	12	77,0	17,6	82	10
2357713	13	77,0	18,8	96	10
2357714	14	77,0	20,4	104	10
2357715	15	77,0	21,0	98	10
2357716	16	77,0	22,0	100	10
2357717	17	77,0	24,0	130	10
2357718	18	77,0	26,0	154	10
2357719	19	77,0	26,0	142	10
2357720	20	77,0	28,0	168	10
2357721	21	77,0	28,0	152	10
2357722	22	77,0	30,0	204	10
2357723	23	77,0	32,0	228	10
2357724	24	77,0	32,0	218	10
2357725	25	77,0	34,0	254	10
2357726	26	77,0	36,0	300	10
2357727	27	77,0	36,0	286	10
2357728	28	77,0	38,0	320	10
2357729	29	77,0	38,0	300	10
2357730	30	77,0	40,0	346	10
2357732	32	77,0	42,0	364	10

SOCKET 1/2", 12 PT.

DIN NO. 3120

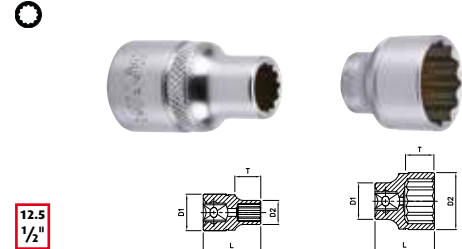

12.5
1/2"

ART. NO.	SIZE	L(MM)	D2(MM)	G	PCS/BAG
23808	8	38,0	12,2	46	10
23809	9	38,0	13,5	48	10
23810	10	38,0	15,0	48	10
23811	11	38,0	16,3	50	10
23812	12	38,0	17,6	50	10
23813	13	38,0	18,8	52	10
23814	14	38,0	20,4	54	10
23815	15	38,0	21,0	52	10
23816	16	38,0	22,0	48	10
23817	17	38,0	24,0	60	10
23818	18	38,0	26,0	70	10
23819	19	38,0	26,0	58	10
23820	20	38,0	28,0	70	10
23821	21	38,0	28,0	60	10
23822	22	38,0	30,0	88	10
23823	23	38,0	32,0	98	10
23824	24	38,0	32,0	90	10
23825	25	42,0	34,0	118	10
23826	26	42,0	36,0	142	10
23827	27	42,0	36,0	136	10
23828	28	43,0	38,0	154	10
23829	29	43,0	38,0	134	10
23830	30	43,0	40,0	158	10
23832	32	43,0	42,0	168	10

SOCKET 1/2", 12 PT. DEEP

DIN NO. 3120

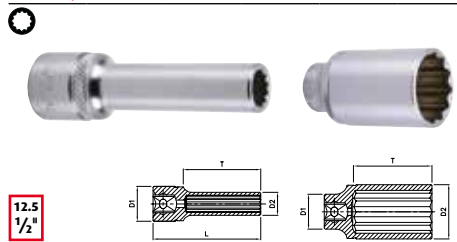

ART. NO.	SIZE	L(MM)	D2(MM)	G	PCS/BAG
2387708	8	77,0	12,2	70	10
2387709	9	77,0	13,5	74	10
2387710	10	77,0	15,0	66	10
2387711	11	77,0	16,3	78	10
2387712	12	77,0	17,6	82	10
2387713	13	77,0	18,8	96	10
2387714	14	77,0	20,4	104	10
2387715	15	77,0	21,0	98	10
2387716	16	77,0	22,0	100	10
2387717	17	77,0	24,0	130	10
2387718	18	77,0	26,0	154	10
2387719	19	77,0	26,0	142	10
2387720	20	77,0	28,0	168	10
2387721	21	77,0	28,0	152	10
2387722	22	77,0	30,0	204	10
2387723	23	77,0	32,0	228	10
2387724	24	77,0	32,0	218	10
2387725	25	77,0	34,0	254	10
2387726	26	77,0	36,0	300	10
2387727	27	77,0	36,0	286	10
2387728	28	77,0	38,0	320	10
2387729	29	77,0	38,0	300	10
2387730	30	77,0	40,0	346	10
2387732	32	77,0	42,0	364	10

SOCKET 1/2", 12 PT. DEEP SAE

DIN NO. 3120

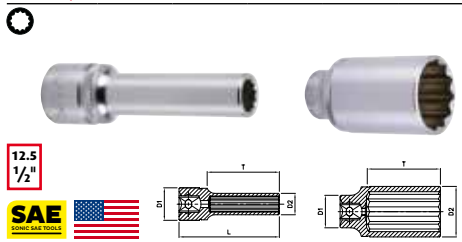

ART. NO.	SIZE	L(MM)	D2(MM)	G	PCS/BAG
2397710	3/8"	77,0	15,0	65	10
2397711	7/16"	77,0	16,3	75	10
2397713	1/2"	77,0	18,8	90	10
2397714	9/16"	77,0	20,4	105	10
2397716	5/8"	77,0	22,0	95	10
2397717	11/16"	77,0	24,0	120	10
2397719	3/4"	77,0	26,0	135	10
2397721	13/16"	77,0	28,0	155	10
2397722	7/8"	77,0	30,0	190	10
2397724	15/16"	77,0	32,0	205	10
2397725	1"	77,0	34,0	235	10
2397727	1.1/16"	77,0	36,0	270	10
2397729	1.1/8"	77,0	38,0	300	10
2397730	1.3/16"	77,0	40,0	330	10
2397732	1.1/4"	77,0	42,0	355	10

CARDAN SOCKET 1/2", TX

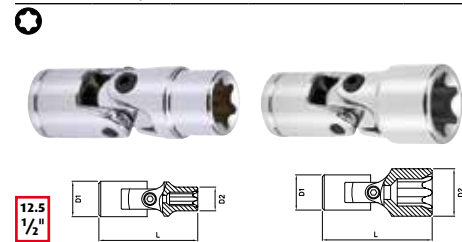

ART. NO.	SIZE	L(MM)	D2(MM)	G	PCS/BAG
7153618	E18	69,0	21,5	138	10
7153620	E20	69,0	21,5	132	10
7153622	E22	69,0	26,0	148	10
7153624	E24	69,0	28,0	154	10

SOCKET 1/2", 12 PT. SAE

DIN NO. 3120

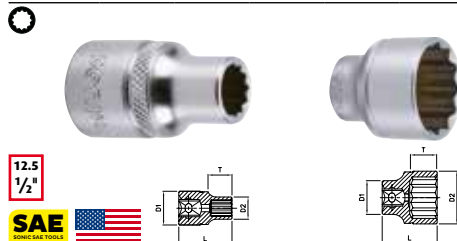

ART. NO.	SIZE	L(MM)	D2(MM)	G	PCS/BAG
23910	3/8"	38,0	15,0	50	10
23911	7/16"	38,0	16,3	45	10
23913	1/2"	38,0	18,8	50	10
23914	9/16"	38,0	20,4	50	10
23916	5/8"	38,0	22,0	50	10
23917	11/16"	38,0	24,0	55	10
23919	3/4"	38,0	26,0	50	10
23921	13/16"	38,0	28,0	60	10
23922	7/8"	38,0	30,0	80	10
23924	15/16"	38,0	32,0	90	10
23925	1"	42,0	34,0	110	10
23927	1.1/16"	42,0	36,0	120	10
23929	1.1/8"	43,0	38,0	135	10
23930	1.3/16"	43,0	40,0	150	10
23932	1.1/4"	43,0	42,0	155	10

SOCKET 1/2", TX

DIN NO. 3120

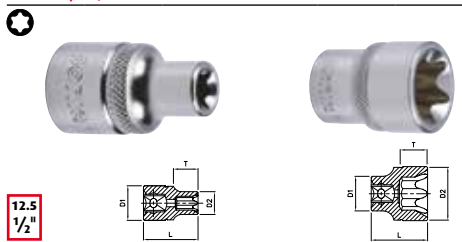

ART. NO.	SIZE	L(MM)	D2(MM)	G	PCS/BAG
23610	E10	38,0	13,0	48	10
23611	E11	38,0	14,0	50	10
23612	E12	38,0	15,0	50	10
23614	E14	38,0	16,0	50	10
23616	E16	38,0	19,0	56	10
23618	E18	38,0	20,0	54	10
23620	E20	38,0	24,0	58	10
23622	E22	38,0	26,0	78	10
23624	E24	38,0	28,0	90	10

SOCKET 1/2", TX DEEP

DIN NO. 3120

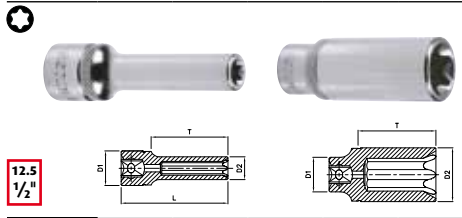

ART. NO.	SIZE	L(MM)	D2(MM)	G	PCS/BAG
2367710	E10	77,0	13,0	78	10
2367711	E11	77,0	14,0	82	10
2367712	E12	77,0	15,0	68	10
2367714	E14	77,0	16,0	74	10
2367716	E16	77,0	19,0	104	10
2367718	E18	77,0	20,0	110	10
2367720	E20	77,0	24,0	156	10
2367722	E22	77,0	26,0	192	10
2367724	E24	77,0	28,0	208	10

SOCKET 3/4", 12 PT.

DIN NO. 3120

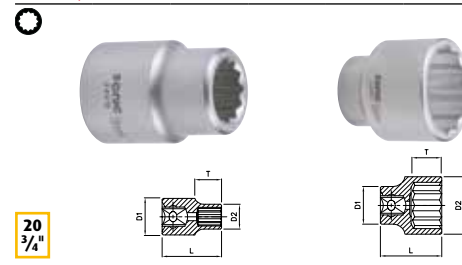

ART. NO.	SIZE	L(MM)	D2(MM)	G	PCS/BAG
24917	17	50,0	27,2	140	2
24918	18	50,0	28,2	150	2
24919	19	50,0	29,2	164	2
24920	20	50,0	30,2	170	2
24921	21	50,0	31,2	166	2
24922	22	50,0	32,2	208	2
24923	23	50,0	33,2	208	2
24924	24	51,0	34,2	214	2
24925	25	52,0	36,0	220	2
24926	26	52,0	37,0	214	2
24927	27	52,0	38,0	214	2
24928	28	52,0	39,5	240	2
24929	29	52,0	40,5	232	2
24930	30	54,0	42,0	274	2
24932	32	56,0	44,0	286	2
24933	33	56,0	46,0	320	2
24934	34	56,0	47,0	340	2
24935	35	58,0	48,0	376	2
24936	36	58,0	50,0	400	2
24938	38	60,0	52,0	464	2
24941	41	64,0	56,0	526	2
24942	42	64,0	57,0	560	2
24946	46	66,0	62,0	632	2
24950	50	70,0	68,0	760	2
24955	55	76,0	74,0	900	2
24960	60	78,0	80,0	1050	2

SOCKET 3/4", 12 PT. SAE

DIN NO. 3120

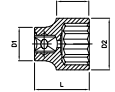

ART. NO.	SIZE	L(MM)	D2(MM)	G	PCS/BAG
24819	3/4"	50,0	29,2	164	2
24822	7/8"	50,0	32,2	212	2
24824	5/16"	51,0	34,2	218	2
24825	1"	52,0	37,0	220	2
24827	1.1/16"	52,0	38,0	220	2
24829	1.1/8"	52,0	40,0	240	2
24830	1.3/16"	54,0	42,0	266	2
24832	1.1/4"	56,0	44,0	286	2
24833	1.5/16"	56,0	46,0	310	2
24835	1.3/8"	58,0	48,0	368	2
24836	1.7/16"	58,0	50,0	398	2
24838	1.1/2"	60,0	52,0	454	2
24841	1.5/8"	64,0	56,0	530	2
24842	1.11/16"	65,0	58,0	560	2
24844	1.3/4"	66,0	60,0	604	2
24846	1.13/16"	68,0	62,0	632	2
24847	1.7/8"	70,0	64,0	700	2
24850	2"	72,0	68,0	760	2

SOCKET 1", 12 PT.

DIN NO. 3120

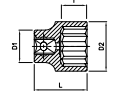
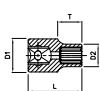

ART. NO.	SIZE	L(MM)	D2(MM)	G	PCS/BAG
25835	35	61,0	50,0	430	2
25836	36	65,0	52,0	454	2
25838	38	65,0	54,0	485	2
25841	41	70,0	57,0	580	2
25846	46	75,0	65,0	806	2
25850	50	75,0	70,0	956	2
25854	54	80,0	74,0	1150	2
25855	55	80,0	76,0	1190	2
25858	58	80,0	79,0	1285	2
25860	60	84,0	82,0	1248	2
25863	63	87,0	86,0	1500	1
25865	65	87,0	88,0	1450	1
25867	67	90,0	90,0	1640	1
25870	70	93,0	94,0	1946	1
25871	71	93,0	95,0	2100	1
25875	75	97,0	100,0	2294	1
25877	77	103,0	102,0	2500	1
25880	80	103,0	105,0	2328	1

WHEEL SOCKET 1/2"

DIN NO. 3121

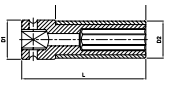

ART. NO.	SIZE	L(MM)	D2(MM)	G	PCS/BAG
3310115	15	85,0	25,0	202	5
3310117	17	86,0	26,4	196	5
3310119	19	86,0	28,4	224	5
3310121	21	86,0	30,4	252	5
3310122	22	85,0	33,0	284	5

WHEEL SOCKET 1/2", 150MML

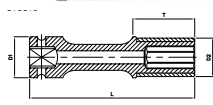

ART. NO.	SIZE	L(MM)	D2(MM)	G	PCS/BAG
3310517	17	150	27	215	5
3310519	19	150	29	265	5
3310521	21	150	31	290	5

WHEEL SOCKET 1/2", 17MM FOR MB

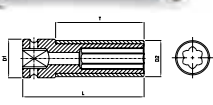

ART. NO.	SIZE	L(MM)	D2(MM)	G	PCS/BAG
3310617	17	88	25	96	5

WHEEL SOCKET 1/2", 105MML

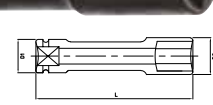

ART. NO.	SIZE	L(MM)	D2(MM)	G	PCS/BAG
3310217	17	105,0	24,0	222	5
3310219	19	105,0	26,0	194	5
3310221	21	105,0	27,0	200	5

TORQUE IMPACT SOCKET 1/2"

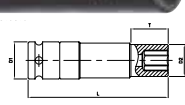

ART. NO.	SIZE	L(MM)	D2(MM)	G	PCS/BAG
3310317	17	100	26	362	5
3310319	19	100	29	392	5
3310321	21	100	30	398	5
3310322	22	100	32	422	5

IMPACT SOCKET 3/8", 6PT.

DIN NO. 3121/3129

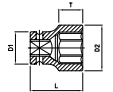

ART. NO.	SIZE	L(MM)	D2(MM)	G	PCS/BAG
32508	8	30,0	13,5	36	10
32509	9	30,0	15,2	42	10
32510	10	30,0	16,5	36	10
32511	11	30,0	17,6	34	10
32512	12	30,0	18,2	34	10
32513	13	30,0	20,2	52	10
32514	14	30,0	21,5	52	10
32515	15	30,0	22,0	48	10
32516	16	30,0	24,0	56	10
32517	17	30,0	25,2	60	10
32518	18	30,0	26,5	90	10
32519	19	30,0	27,7	66	10
32520	20	30,0	28,5	95	10
32521	21	30,0	30,0	100	10
32522	22	30,0	32,0	105	10

IMPACT SOCKET 3/8", 6PT. DEEP

DIN NO. 3121/3129

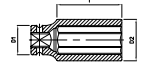
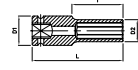

ART. NO.	SIZE	L(MM)	D2(MM)	G	PCS/BAG
3256308	8	63,0	13,5	96	10
3256309	9	63,0	15,2	100	10
3256310	10	63,0	16,5	92	10
3256311	11	63,0	17,6	86	10
3256312	12	63,0	18,2	86	10
3256313	13	63,0	20,2	116	10
3256314	14	63,0	21,5	114	10
3256315	15	63,0	22,6	130	10
3256316	16	63,0	24,0	122	10
3256317	17	63,0	25,2	146	10
3256318	18	63,0	26,5	190	10
3256319	19	63,0	27,7	156	10
3256320	20	63,0	28,5	210	10
3256321	21	63,0	30,0	220	10
3256322	22	63,0	32,0	240	10

IMPACT SOCKET 1/2", 17MM FOR MB

DIN NO. 3121

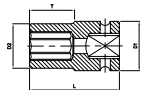

ART. NO.	SIZE	L(MM)	D2(MM)	G	PCS/BAG
3310417	17	80	30	222	5

BRAKE CALIPER SOCKET, 1/2" 10 PT. 38MML

DIN NO. 3121

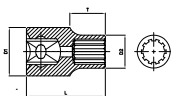

12.5
1/2"

ART. NO	SIZE	L(MM)	D2(MM)	G	PCS/BAG
805019	10	38	16	42	10

IMPACT SOCKET 1/2", 6PT.

DIN NO. 3121/3129

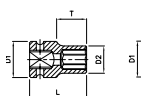

12.5
1/2"

ART. NO.	SIZE	L(MM)	D2(MM)	G	PCS/BAG
33508	8	38,0	15,0	60	5
33509	9	38,0	16,0	60	5
33510	10	38,0	16,0	60	5
33511	11	38,0	17,2	62	5
33512	12	38,0	19,0	64	5
33513	13	38,0	20,5	68	5
33514	14	38,0	23,0	80	5
33515	15	38,0	24,0	76	5
33516	16	38,0	24,0	72	5
33517	17	38,0	25,8	90	5
33518	18	38,0	28,0	108	5
33519	19	38,0	28,0	102	5
33520	20	38,0	29,8	120	5
33521	21	38,0	29,8	114	5
33522	22	38,0	31,8	132	5
33523	23	38,0	32,2	118	5
33524	24	38,0	33,8	126	5
33525	25	38,0	35,8	142	5
33526	26	38,0	35,8	134	5
33527	27	39,0	37,8	156	5
33528	28	40,0	40,0	164	5
33529	29	40,0	40,0	162	5
33530	30	40,0	41,8	184	5
33532	32	40,0	43,5	188	5
33533	33	44,0	46,0	310	5
33534	34	44,0	46,0	320	5
33535	35	48,0	48,0	330	5
33536	36	48,0	49,0	330	5
33538	38	48,0	52,0	480	5

IMPACT SOCKET 1/2", 6PT. DEEP

DIN NO. 3121/3129

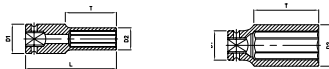

12.5
1/2"

ART. NO.	SIZE	L(MM)	D2(MM)	G	PCS/BAG
3358508	8	78,0	15,0	125	5
3358509	9	78,0	16,0	125	5
3358510	10	78,0	17,5	138	5
3358511	11	78,0	17,5	152	5
3358512	12	78,0	19,8	160	5
3358513	13	78,0	20,8	148	5
3358514	14	78,0	22,2	158	5
3358515	15	78,0	23,8	168	5
3358516	16	78,0	23,8	160	5
3358517	17	78,0	25,2	176	5
3358518	18	78,0	27,8	214	5
3358519	19	78,0	27,8	210	5
3358520	20	78,0	30,0	266	5
3358521	21	78,0	29,5	238	5
3358522	22	78,0	31,8	266	5
3358523	23	78,0	33,8	312	5
3358524	24	78,0	33,8	384	5
3358525	25	78,0	36,0	338	5
3358526	26	78,0	38,0	364	5
3358527	27	78,0	37,8	346	5
3358528	28	78,0	40,0	414	5
3358529	29	78,0	40,0	400	5
3358530	30	78,0	42,0	422	5
3358532	32	78,0	43,8	436	5
3358533	33	78,0	46,0	440	5
3358534	34	78,0	46,0	480	5
3358535	35	78,0	48,0	520	5
3358536	36	78,0	49,0	500	5
3358538	38	78,0	52,0	600	5

IMPACT SOCKET 1/2", 12PT DEEP

DIN NR. 3121

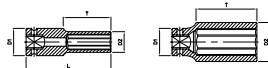

12.5
1/2"

ART. NO.	SIZE	L(MM)	D2(MM)	G	PCS/BAG
3397824	24	78	34	260	5
3397827	27	78	38	300	5
3397834	34	78	46	480	5
3397835	35	78	48	520	5

IMPACT SOCKET 1/2", 12PT. DEEP

DIN NO. 3121

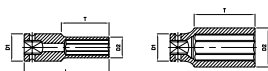

12.5
1/2"

ART. NO.	SIZE	L(MM)	D2(MM)	G	PCS/BAG
3398530	30	85,0	42,0	402	5
3398532	32	85,0	44,0	420	5
3398534	34	85,0	46,0	452	2
3398535	35	85,0	48,0	492	2
3398536	36	85,0	50,0	508	2

1/2" IMPACT CARDAN SOCKET

DIN NO. 3121

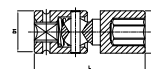

12.5
1/2"

ART. NO.	SIZE	L(MM)	D2(MM)	G	PCS/BAG
7150216	16	68	24,5	173	10
7150217	17	68	26,0	176	10
7150218	18	68	27,0	181	10
7150219	19	68	28,0	182	10

IMPACT SOCKET 1/2", TX 78MML

DIN NO. 3121

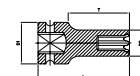

12.5
1/2"

ART. NO.	SIZE	L(MM)	D2(MM)	G	PCS/BAG
3367810	E10	78	12,45	82	5
3367811	E11	78	13,06	84	5
3367812	E12	78	14,52	88	5
3367814	E14	78	16	94	5
3367816	E16	78	19,14	118	5
3367818	E18	78	22	130	5
3367820	E20	78	23	152	5
3367822	E22	78	25	174	5
3367824	E24	78	27	214	5

IMPACT SOCKET 3/4", 6PT.

DIN NO. 3121/3129

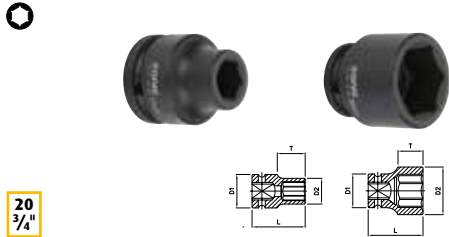

20
3/4"

ART. NO.	SIZE	L(MM)	D2(MM)	G	PCS/BAG
34517	17	51,0	29,0	328	2
34518	18	51,0	30,0	320	2
34519	19	51,0	32,0	325	2
34520	20	51,0	33,0	330	2
34521	21	51,0	35,0	340	2
34522	22	51,0	36,0	345	2
34523	23	51,0	38,0	350	2
34524	24	51,0	39,0	350	2
34525	25	54,0	41,0	360	2
34526	26	54,0	41,0	360	2
34527	27	54,0	42,0	370	2
34528	28	54,0	44,0	386	2
34529	29	54,0	46,0	410	2
34530	30	54,0	46,0	410	2
34532	32	57,0	48,0	450	2
34533	33	57,0	50,0	480	2
34534	34	57,0	52,0	490	2
34535	35	57,0	52,0	490	2
34536	36	57,0	54,0	536	2
34538	38	57,0	56,0	540	2
34539	39	57,0	58,0	540	2
34540	40	57,0	58,0	560	2
34541	41	58,0	60,0	610	2
34542	42	58,0	62,0	630	2
34543	43	63,0	63,0	670	2
34544	44	63,0	64,0	670	2
34545	45	63,0	66,0	710	2
34546	46	63,0	66,0	710	2
34547	47	68,0	68,0	800	2
34548	48	68,0	68,0	800	2
34550	50	68,0	71,0	850	2
34552	52	68,0	74,0	900	2
34554	54	73,0	76,0	950	2
34555	55	73,0	77,0	1100	2
34557	57	73,0	80,0	1200	2
34558	58	73,0	81,0	1300	2
34559	59	73,0	84,0	1400	2
34560	60	75,0	84,0	1400	2
34563	63	75,0	86,0	1600	2
34565	65	78,0	88,0	1700	2
34570	70	84,0	96,0	1900	2

IMPACT SOCKET 3/4", 6PT. DEEP

DIN NO. 3121/3129

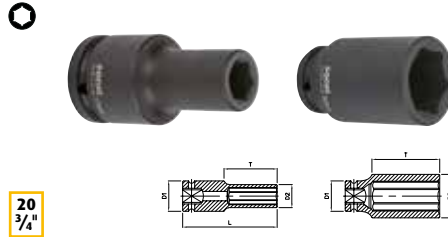

20
3/4"

ART. NO.	SIZE	L(MM)	D2(MM)	G	PCS/BAG
3459017	17	90,0	29,0	540	2
3459018	18	90,0	30,0	530	2
3459019	19	90,0	32,0	550	2
3459020	20	90,0	33,0	560	2
3459021	21	90,0	35,0	570	2
3459022	22	90,0	36,0	590	2
3459023	23	90,0	38,0	610	2
3459024	24	90,0	39,0	610	2
3459025	25	90,0	41,0	620	2
3459026	26	90,0	41,0	620	2
3459027	27	90,0	42,0	640	2
3459028	28	90,0	44,0	644	2
3459029	29	90,0	46,0	680	2
3459030	30	90,0	46,0	700	2
3459032	32	90,0	48,0	730	2
3459033	33	90,0	50,0	780	2
3459034	34	90,0	52,0	810	2
3459035	35	90,0	52,0	810	2
3459036	36	90,0	54,0	850	2
3459038	38	90,0	56,0	880	2
3459039	39	90,0	58,0	920	2
3459040	40	90,0	58,0	920	2
3459041	41	90,0	60,0	960	2
3459042	42	90,0	62,0	1050	2
3459043	43	90,0	63,0	1150	2
3459044	44	90,0	64,0	1150	2
3459045	45	90,0	66,0	1200	2
3459046	46	90,0	66,0	1200	2
3459047	47	90,0	68,0	1300	2
3459048	48	90,0	68,0	1300	2
3459050	50	90,0	71,0	1400	2
3459052	52	90,0	74,0	1600	2
3459054	54	90,0	76,0	1900	2
3459055	55	90,0	77,0	1940	2

IMPACT SOCKET 1", 6PT.

DIN NO. 3121/3129

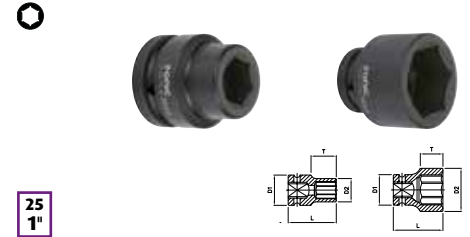

25
1"

ART. NO.	SIZE	L(MM)	D2(MM)	G	PCS/BAG
35524	24	58,0	42,0	574	2
35525	25	58,0	43,0	570	2
35526	26	58,0	44,0	570	2
35527	27	58,0	46,0	580	2
35528	28	58,0	46,0	580	2
35530	30	62,0	49,0	610	2
35532	32	62,0	52,0	660	2
35533	33	62,0	54,0	682	2
35534	34	62,0	54,0	710	2
35535	35	62,0	54,0	710	2
35536	36	65,0	56,0	720	2
35538	38	65,0	58,0	740	2
35540	40	65,0	60,0	750	2
35541	41	68,0	61,0	792	2
35542	42	68,0	64,0	850	2
35543	43	68,0	66,0	890	2
35544	44	68,0	67,0	930	2
35545	45	68,0	67,0	930	2
35546	46	72,0	68,0	1010	2
35548	48	72,0	70,0	1060	2
35550	50	75,0	74,0	1164	2
35551	51	75,0	74,0	1250	2
35552	52	75,0	75,0	1250	2
35553	53	80,0	76,0	1300	2
35554	54	80,0	78,0	1400	2
35555	55	83,0	80,0	1480	2
35557	57	83,0	82,0	1540	2
35558	58	83,0	84,0	1650	2
35559	59	87,0	85,0	1700	2
35560	60	87,0	86,0	1750	2
35563	63	87,0	90,0	1800	2
35565	65	90,0	92,0	1850	2
35566	66	90,0	93,0	1950	2
35568	68	93,0	95,0	2000	2
35570	70	93,0	97,0	2100	2
35571	71	95,0	101,0	2500	2
35575	75	95,0	104,0	2800	2
35580	80	95,0	112,0	2900	2
35585	85	100,0	115,0	3200	2
35590	90	105,0	124,0	3800	2
35595	95	105,0	130,0	5250	2

IMPACT SOCKET 3/4", 12PT.

DIN NO. 3121

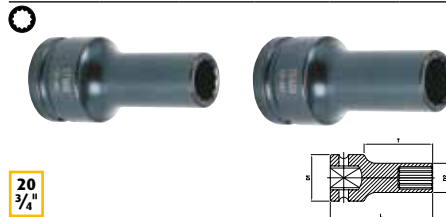

20
3/4"

ART. NO.	SIZE	L(MM)	D2(MM)	G	PCS/BAG
3499017	17	90,0	26,0	450	2
3499019	19	90,0	28,0	470	2

IMPACT SOCKET 3/4", TX

DIN NO. 3121

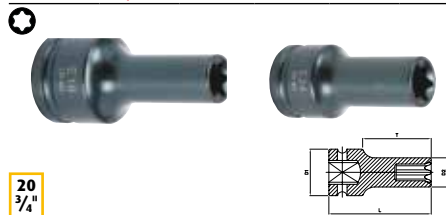

20
3/4"

ART. NO.	SIZE	L(MM)	D2(MM)	G	PCS/BAG
3469018	E18	90,0	22,0	412	2
3469020	E20	90,0	24,0	426	2
3469024	E24	90,0	28,0	500	2

IMPACT SOCKET 1", 6PT. DEEP

DIN NO. 3121/3129

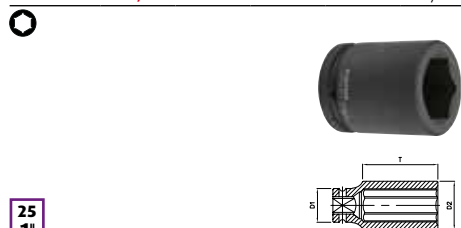

25
1"

ART. NO.	SIZE	L(MM)	D2(MM)	G	PCS/BAG
3559024	24	90,0	42,0	868	2
3559025	25	90,0	43,0	850	2
3559026	26	90,0	44,0	870	2
3559027	27	90,0	46,0	890	2
3559028	28	90,0	47,0	890	2
3559030	30	90,0	49,0	930	2
3559032	32	90,0	52,0	960	2
3559033	33	90,0	54,0	1000	2
3559034	34	90,0	54,0	1000	2
3559035	35	90,0	54,0	1000	2
3559036	36	90,0	56,0	1050	2
3559038	38	95,0	58,0	1150	2
3559040	40	95,0	60,0	1200	2
3559041	41	95,0	61,0	1220	2
3559042	42	95,0	64,0	1250	2
3559043	43	95,0	66,0	1270	2
3559044	44	95,0	67,0	1300	2
3559045	45	95,0	67,0	1300	2
3559046	46	95,0	68,0	1350	2
3559048	48	100,0	70,0	1500	2
3559050	50	100,0	74,0	1600	2
3559051	51	100,0	75,0	1650	2
3559052	52	100,0	75,0	1650	2
3559053	53	100,0	76,0	1700	2
3559054	54	100,0	78,0	1750	2
3559055	55	105,0	80,0	1900	2
3559057	57	105,0	82,0	1950	2
3559058	58	105,0	84,0	2000	2
3559059	59	110,0	85,0	2050	2
3559060	60	110,0	87,0	2100	2
3559063	63	110,0	90,0	2200	2
3559065	65	115,0	92,0	2350	2
3559066	66	115,0	93,0	2450	2
3559068	68	120,0	95,0	2550	2
3559070	70	120,0	97,0	2650	2
3559071	71	135,0	101,0	3000	2
3559075	75	135,0	104,0	4000	2
3559076	76	135,0	106,0	4000	2
3559080	80	135,0	112,0	4500	2
3559085	85	140,0	115,0	5250	2
3559090	90	140,0	124,0	5750	2
3559095	95	140,0	130,0	6300	2

SPARK PLUG SOCKET 3/8" 6PT.

DIN NO. 3120

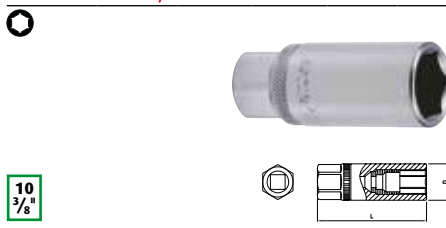

10
3/8"

ART. NO.	SIZE	L(MM)	D(MM)	G	PCS/BAG
7171216	16	65,0	22,0	94	10
7171218	18	65,0	26,0	130	10
7171221	21	65,0	28,0	136	10

SPARK PLUG CLIP SOCKET 3/8"

DIN NO. 3120

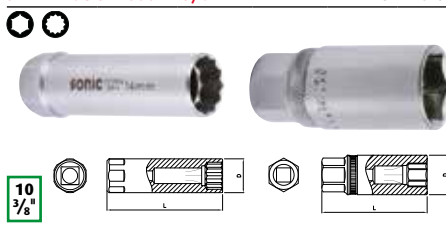

10
3/8"

ART. NO.	SIZE	L(MM)	D(MM)	G	PCS/BAG
7172214	14	63,0	18,0	58	10
7172216	16	64,0	22,0	100	10
7172218	18	64,0	26,0	158	10
7172221	21	64,0	28,0	158	10

SPARK PLUG SOCKET 3/8" 12-PT.

DIN NO. 3120



10
3/8"

ART. NO.	SIZE	L(MM)	D(MM)	G	PCS/BAG
7174214	14	90	19,0	104	10
7175214	14	250	19,0	262	10

SPARK PLUG SOCKET 1/2" 6PT.

DIN NO. 3120



12.5
1/2"

ART. NO.	SIZE	L(MM)	D(MM)	G	PCS/BAG
7171316	16	65,0	22,0	90	10
7171318	18	65,0	26,0	140	10
7171321	21	65,0	28,0	145	10

SPARK PLUG CLIP SOCKET 1/2" 6PT.

DIN NO. 3120



12.5
1/2"

ART. NO.	SIZE	L(MM)	D(MM)	G	PCS/BAG
7172316	16	68,0	22,0	95	10
7172318	18	68,0	26,0	155	10
7172321	21	68,0	28,0	160	10

FOR MORE SOCKETS SEE:



SONIC FOAM SYSTEM
PAGE 121



PAGE 145



SOCKETS ON RAIL
PAGE 155



GENERAL TOOL SOCKETS
PAGE 163



**WORKPLACE JOHAN MEURE
PURMEREND, THE NETHERLANDS**

Wrenches



EUROPEAN HANGER +
EAN-CODE + ART. NO.



THE SONIC WRENCHES HAVE THE ABILITY TO BRING STRENGTH ONTO THE BOLTS AND NUTS DUE TO ITS OUTSTANDING GRIP ON THE FLANKS, WITHOUT DOING DAMAGE TO ANY OF THE MATERIAL. THE POSSIBILITY TO DAMAGE THE EDGES OF BOLTS IS NO LONGER AN ISSUE.

PROGRAM OF SONIC WRENCHES:

- COMBINATION WRENCHES
- DOUBLE OPEN WRENCHES
- FLARE NUT WRENCHES
- HINGED SOCKET WRENCHES
- REVERSIBLE COMBINATION RATCHETING WRENCHES
- FLEXIBLE COMBINATION RATCHETING WRENCHES
- FLAT COMBINATION RATCHETING WRENCHES
- 45° OFFSET RING WRENCHES
- 75° OFFSET RING WRENCHES
- FLAT DOUBLE RING WRENCHES
- HALF MOON WRENCHES
- STUBBY COMBINATION WRENCHES



MINIMUM TOLERANCE, MORE POWERFUL TIGHTENING REDUCES STRESS FROM LARGER CONTACT AREAS AND NO SHARP ANGLES WITHIN THE TOOL. TORQUE TRANSMISSION THROUGH FASTENER FLATS, LONGER LIFE



CONTINUOUSLY TESTED FOR ACCURATE SIZING



ERGONOMIC SHAPE, PERFECT GRIP



STREAMLINED DOUBLE POLISHED HEADS IMPROVE MANOEUVRABILITY AND USER COMFORT. RECESSED FASTENERS ARE EASIER TO REACH AND ROTATE, EVEN IN CONFINED SPACES, 30° INCREMENTS

74

ALL SONIC WRENCHES ARE MANUFACTURED FROM A HIGH GRADE OF CHROME VANADIUM STEEL WITH A SUPERB FINISHMENT, TIGHT TOLERANCES ON SIZES AND DIMENSIONS. HIGH QUALITY FINISHMENT ENSURES PERFECT FIT ON FASTENERS AND USER COMFORT.

COMPACT DESIGN



REVERSIBLE



SLIM PROFILE, HIGH QUALITY ENSURES PERFECT FIT



WORK EFFICIENT
WORK WITH SONIC

TORQUE TEST

SONIC WRENCHES MEET UP TO MORE THAN 2.5 TIMES THE DIN STANDARD.
SONIC WRENCHES ARE MADE OF CHROME VANADIUM STEEL AND MANUFACTURED UNDER
HIGH STANDARD INDUSTRIAL REQUIREMENTS.



SONIC TORQUE TEST

ART. NO.	DESCRIPTION	SONIC WRENCH(NM)	DIN (NM) STANDARD	ABOVE STANDARD DIN(%)
41508	COMBINATION WRENCH 8	73	34.5	211.6%
41509	COMBINATION WRENCH 9	95	45.4	209.3%
41510	COMBINATION WRENCH 10	95	58.1	163.5%
41511	COMBINATION WRENCH 11	151	72.7	207.7%
41512	COMBINATION WRENCH 12	204	89.1	229.0%
41513	COMBINATION WRENCH 13	218	107.0	203.7%
41514	COMBINATION WRENCH 14	255	128.0	199.2%
41515	COMBINATION WRENCH 15	370	150.0	246.7%
41516	COMBINATION WRENCH 16	363	175.0	207.4%
41517	COMBINATION WRENCH 17	484	201.0	240.8%
41518	COMBINATION WRENCH 18	553	230.0	240.4%
41519	COMBINATION WRENCH 19	588	261.0	225.3%
41520	COMBINATION WRENCH 20	714	294.0	242.9%
41521	COMBINATION WRENCH 21	1023	330.0	310.0%
41522	COMBINATION WRENCH 22	899	368.0	244.3%
41523	COMBINATION WRENCH 23	1082	408.0	265.2%
41524	COMBINATION WRENCH 24	1032	451.0	228.8%
41525	COMBINATION WRENCH 25	1316	496.0	265.3%
41526	COMBINATION WRENCH 26	1443	544.0	265.3%
41527	COMBINATION WRENCH 27	1629	594.0	274.2%
41528	COMBINATION WRENCH 28	1623	647.0	250.9%
41529	COMBINATION WRENCH 29	1650	-	-
41530	COMBINATION WRENCH 30	1953	760.0	257.0%
41532	COMBINATION WRENCH 32	2318	884.0	262.2%

FLARE NUT WRENCH

DIN NO. 3118

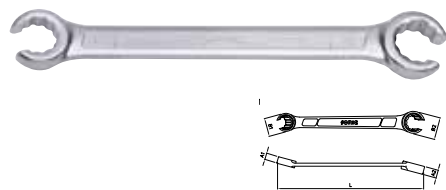

ART. NO.	SIZE	L(MM)	B1(MM)	B2(MM)	G	PCS/BAG
4110810	8X10	145	18,4	20,8	52	10
4111113	11X13	165	22,6	25,0	90	10
4111214	12X14	178	25,0	27,4	130	10
4111618	16X18	196	30,0	27,4	136	10
4111719	17X19	210	30,0	32,5	188	10
4111922	19X22	233	32,5	38,0	240	10
4112427	24X27	265	41,0	45,0	346	5
4113032	30X32	285	48,5	51,0	482	5

HINGED SOCKET WRENCH

DIN NO. 3118

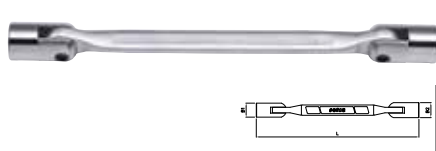

ART. NO.	SIZE	L(MM)	B1(MM)	B2(MM)	G	PCS/BAG
4120607	6X7	184	9,5	10,9	72	10
4120809	8X9	180	13,0	14,0	78	10
4121011	10X11	200	15,0	16,0	106	10
4121213	12X13	220	18,0	19,0	160	10
4121415	14X15	242	20,0	22,0	240	10
4121617	16X17	260	24,0	24,0	326	10
4121819	18X19	275	26,0	26,0	394	10
4122022	20X22	305	28,0	30,5	572	10
4122123	21X23	305	29,8	33,0	616	10
4122427	24X27	335	33,0	37,0	774	10

DOUBLE OPEN WRENCH

DIN NO. 3110

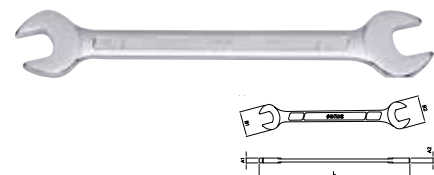

ART. NO.	SIZE	L(MM)	B1(MM)	B2(MM)	G	PCS/BAG
4140607	6X7	123	15,5	18,0	22	10
4140809	8X9	140	20,4	22,7	32	10
4141011	10X11	156	23,6	25,7	58	10
4141213	12X13	172	28,2	30,3	80	10
4141415	14X15	190	33,3	35,3	98	10
4141617	16X17	204	36,1	37,9	134	10
4141819	18X19	221	39,2	41,5	158	10
4142022	20X22	237	45,4	49,5	212	10
4142123	21X23	247	45,2	48,5	232	10
4142224	22X24	247	46,8	50,8	225	10
4142427	24X27	263	51,9	58,1	314	5
4142528	25X28	279	53,8	60,3	386	5
4143032	30X32	298	64,4	68,8	486	5
4143436	34X36	350	69,8	76,0	600	5

FLARE NUT WRENCH SAE

DIN NO. 3118

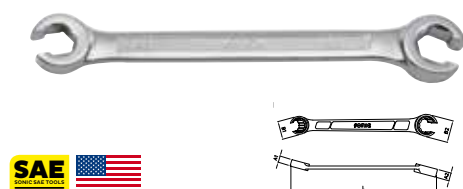

ART. NO.	SIZE	L(MM)	B1(MM)	B2(MM)	G	PCS/BAG
4250608	1/4"X5/16"	135	16,2	17,9	38	10
4251011	3/8"X7/16"	152	20,8	22,6	68	10
4251314	1/2"X9/16"	178	25,0	27,4	124	10
4251617	5/8"X11/16"	196	27,4	30,0	136	10

HINGED TX E WRENCH

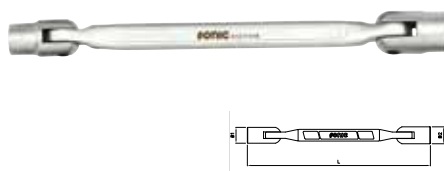

ART. NO.	SIZE	L(MM)	B1(MM)	B2(MM)	G	PCS/BAG
41210608	E6XE8	183	8,3	9,9	76	10
41211012	E10XE12	201	12,0	15,0	108	10
41211418	E14XE18	220	16,3	19,0	202	10
41212024	E20XE24	250	22,0	26,0	334	10

DOUBLE OPEN WRENCH SAE

DIN NO. 3110

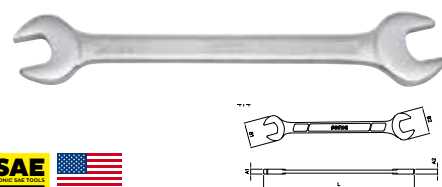

ART. NO.	SIZE	L(MM)	B1(MM)	B2(MM)	G	PCS/BAG
4220608	1/4"X5/16"	123	14,5	17,3	24	5
4221011	3/8"X7/16"	156	23,8	26,0	60	5
4221314	1/2"X9/16"	180	30,3	32,3	88	5
4221617	5/8"X11/16"	204	35,5	37,6	132	5
4221719	11/16"X3/4"	221	39,6	41,3	162	5
4222122	13/16"X7/8"	237	43,7	47,7	208	5
4222425	15/16"X1"	255	49,1	55,2	288	5
4222932	1.1/8"X1.1/4"	298	64,0	68,4	508	5

FLEXIBLE FLARE NUT WRENCH

DIN NO. 3118

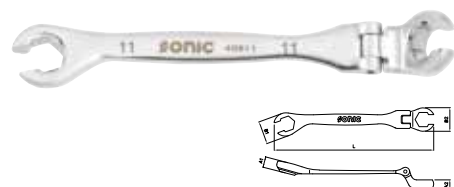

ART. NO.	SIZE	L(MM)	B1(MM)	B2(MM)	G	PCS/BAG
40808	8	128	18,0	18,0	50	10
40809	9	128	18,0	18,0	48	10
40810	10	128	18,0	18,0	48	10
40811	11	148	22,0	22,0	82	10
40812	12	148	22,0	22,0	78	10

HINGED DRIVER 1/4"DR.-1/4"INHEX

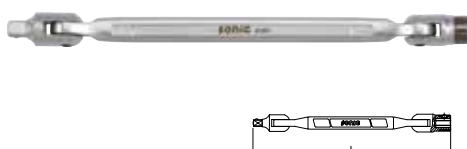

ART. NO.	SIZE	L(MM)	B1(MM)	B2(MM)	G	PCS/BAG
41201	1/4	188	13,9	12,9	80	10

HINGED DRIVER 1/4" X 3/8"

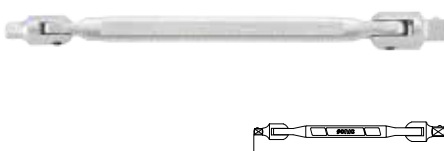

ART. NO.	SIZE	L(MM)	B1(MM)	B2(MM)	G	PCS/BAG
41202	1/4" X 3/8"	208	18,0	14,0	122	10

FLEXIBLE FLARE NUT WRENCH

DIN NO. 3118

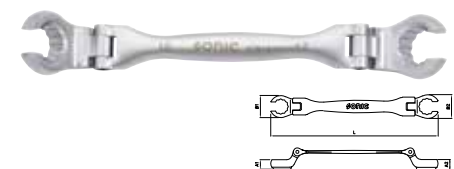

ART. NO.	SIZE	L(MM)	B1(MM)	B2(MM)	G	PCS/BAG
4080809	8X9	150	19,0	19,0	66	10
4081011	10X11	158	19,0	22,7	76	10
4081213	12X13	180	23,0	26,8	120	10

COMBINATION WRENCH

DIN NO. 3113

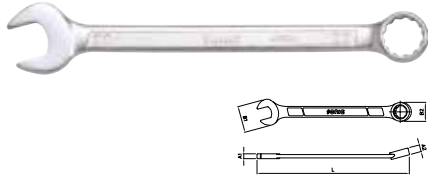

ART. NO.	SIZE	L(MM)	B1(MM)	B2(MM)	G	PCS/BAG
41506	6	105	15,5	10,1	14	10
41507	7	115	17,0	11,5	20	10
41508	8	125	19,2	12,8	30	10
41509	9	135	21,2	14,2	32	10
41510	10	145	23,2	15,6	38	10
41511	11	155	25,3	16,9	50	10
41512	12	165	27,2	18,3	66	10
41513	13	175	29,4	19,7	70	10
41514	14	185	31,5	21,2	84	10
41515	15	195	33,2	22,5	94	10
41516	16	205	34,7	24,0	108	10
41517	17	215	36,5	25,3	128	10
41518	18	225	38,7	26,8	148	10
41519	19	235	40,7	28,1	160	10
41520	20	245	43,1	29,7	178	10
41521	21	255	44,8	31,3	210	10
41522	22	265	46,9	32,6	250	10
41523	23	275	48,3	34,2	254	10
41524	24	285	50,4	35,5	328	5
41525	25	295	52,0	36,9	314	5
41526	26	305	53,6	38,2	348	5
41527	27	315	55,7	39,6	380	5
41528	28	325	57,6	40,9	430	5
41529	29	335	58,3	42,3	436	5
41530	30	345	61,8	43,7	530	5
41532	32	365	65,8	46,4	570	5
41533	33	380	69,2	48,8	630	2
41534	34	380	69,2	44,8	630	2
41535	35	410	74,0	53,0	800	2
41536	36	410	74,0	53,0	800	2
41538	38	430	77,0	56,0	1000	2
41541	41	460	84,0	61,0	1160	2
41543	43	460	84,0	61,0	1160	2
41546	46	500	92,0	66,0	1700	2
41548	48	540	102,0	73,0	2000	2
41550	50	540	102,0	73,0	2000	2
41555	55	560	118,0	86,0	2800	2
41558	58	600	126,0	94,0	3900	2
41560	60	600	126,0	94,0	3900	2
41565	65	680	148,0	108,0	5800	2
41570	70	680	148,0	108,0	5800	2
41575	75	730	155,0	115,0	6650	2
41580	80	730	155,0	115,0	6510	2
41585	85	790	179,0	131,0	10000	2

COMBINATION WRENCH EXTRA LONG

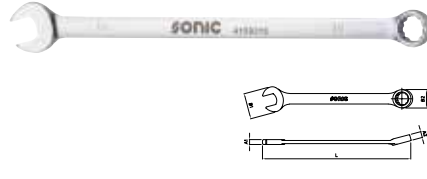

ART. NO.	SIZE	L(MM)	B1(MM)	B2(MM)	G	PCS/BAG
4150310	10	189	23,4	16,4	54	10
4150311	11	207	25,2	17,9	75	10
4150312	12	225	27,8	19,4	88	10
4150313	13	243	29,2	21,0	104	10
4150314	14	261	32,0	22,4	149	10
4150315	15	279	34,1	24,0	167	10
4150316	16	297	35,9	25,4	203	10
4150317	17	314	38,2	26,8	231	10
4150318	18	333	40,0	28,1	272	10
4150319	19	349	42,1	29,3	298	10

COMBINATION WRENCH SAE

DIN NO. 3113

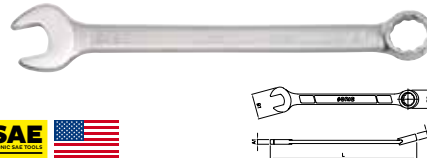

ART. NO.	SIZE	L(MM)	B1(MM)	B2(MM)	G	PCS/BAG
4150206	1/4"	105	15,5	10,1	16	10
4150208	5/16"	125	19,2	12,8	26	10
4150210	3/8"	145	23,2	15,6	40	10
4150211	7/16"	155	25,3	16,9	52	10
4150213	1/2"	175	29,4	19,7	70	10
4150214	9/16"	185	31,5	21,2	88	10
4150216	5/8"	205	34,7	24,0	114	10
4150217	11/16"	215	36,5	25,3	126	10
4150219	3/4"	235	40,7	28,1	170	10
4150221	13/16"	255	44,8	31,3	196	10
4150222	7/8"	265	46,9	32,6	218	10
4150224	15/16"	285	50,4	35,5	308	10
4150225	1"	300	52,0	37,5	325	10
4150227	1-1/16"	315	55,8	39,0	410	10
4150228	1-1/8"	335	58,5	42,2	460	10
4150232	1-1/4"	365	65,0	46,5	600	10
4150233	1-5/16"	380	67,2	49,0	640	5
4150235	1-3/8"	410	73,4	53,8	820	5
4150238	1-1/2"	430	76,6	57,8	1000	5
4150241	1-5/8"	460	83,5	61,8	1200	5

STUBBY COMBINATION WRENCH



ART. NO.	SIZE	L(MM)	B1(MM)	B2(MM)	G	PCS/BAG
42608	8	91	17,1	12,8	20	10
42609	9	97	21,4	15,0	30	10
42610	10	97	21,4	15,0	34	10
42611	11	100	23,7	17,3	44	10
42612	12	105	25,9	18,4	46	10
42613	13	108	26,8	19,7	50	10
42614	14	115	29,8	21,7	68	10
42615	15	118	31,6	22,8	80	10
42616	16	122	33,8	24,2	84	10
42617	17	130	36,2	25,4	102	10

REVERSIBLE RATCHETING WRENCH 12PT.

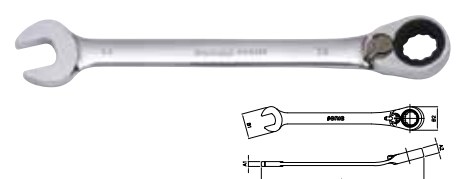

ART. NO.	SIZE	L(MM)	B1(MM)	B2(MM)	G	PCS/BAG
4170208	8	136	16,7	17,6	36	10
4170209	9	143	19,4	19,1	44	10
4170210	10	159	21,5	20,7	58	10
4170211	11	168	23,9	22,7	70	10
4170212	12	174	26,0	24,0	84	10
4170213	13	180	27,3	26,1	100	10
4170214	14	189	31,2	27,8	116	10
4170215	15	200	32,5	29,2	140	10
4170216	16	216	34,1	31,6	158	10
4170217	17	232	37,5	33,5	200	10
4170218	18	239	39,0	33,7	202	10
4170219	19	247	40,7	35,1	250	10

REVERSIBLE STUBBY RATCHETING WRENCH 12PT.



ART. NO.	SIZE	L(MM)	B1(MM)	B2(MM)	G	PCS/BAG
417708	8	90	18	19,4	36	10
417709	9	90	18	20,5	42	10
417710	10	95	22	21,5	48	10
417711	11	103	24	23	56	10
417712	12	106	26	24,8	67	10
417713	13	108	28	26,1	75	10
417714	14	115	31	27,6	89	10
417715	15	119	32	29,2	104	10
417716	16	123	34	30,9	111	10
417717	17	127	36	32,3	143	10
417718	18	131	38	34	150	10
417719	19	139	41	35,5	183	10

FLEXIBLE RATCHETING WRENCH 12PT.

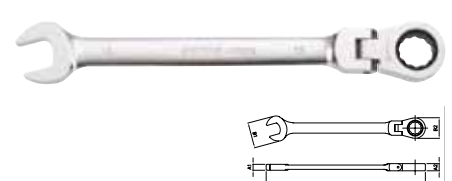

ART. NO.	SIZE	L(MM)	B1(MM)	B2(MM)	G	PCS/BAG
4170308	8	136	17,1	17,5	38	10
4170309	9	143	19,2	19,3	44	10
4170310	10	160	21,3	21,0	66	10
4170311	11	168	23,7	22,7	76	10
4170312	12	174	25,8	24,0	92	10
4170313	13	180	26,8	26,0	106	10
4170314	14	193	30,4	27,7	128	10
4170315	15	200	32,1	29,1	148	10
4170316	16	216	33,8	30,7	186	10
4170317	17	233	37,0	32,6	218	10
4170318	18	239	38,7	33,7	226	10
4170319	19	250	40,2	34,8	268	10

FLAT RATCHETING WRENCH 6PT.

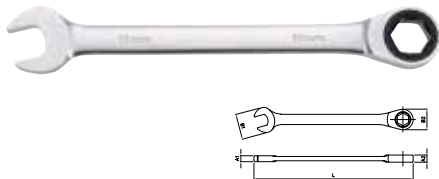

ART. NO.	SIZE	L(MM)	B1(MM)	B2(MM)	G	PCS/BAG
4170408	8	135	16,5	17,1	40	10
4170409	9	160	20,2	20,7	62	10
4170410	10	160	20,2	20,7	56	10
4170411	11	166	22,4	22,6	70	10
4170412	12	169	24,9	23,8	84	10
4170413	13	179	26,4	24,9	100	10
4170414	14	191	28,2	27,0	110	10
4170415	15	199	31,0	28,1	136	10
4170416	16	206	33,3	29,9	162	10
4170417	17	225	35,5	31,9	178	10
4170418	18	236	36,4	33,4	210	10
4170419	19	247	38,4	34,4	234	10

FLAT RATCHETING WRENCH 12PT.

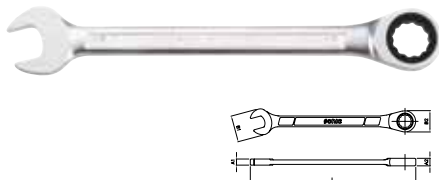

ART. NO.	SIZE	L(MM)	B1(MM)	B2(MM)	G	PCS/BAG
4170108	8	129	18,8	18,0	32	10
4170109	9	139	20,8	19,5	40	10
4170110	10	149	22,8	21,0	50	10
4170111	11	159	24,9	23,0	60	10
4170112	12	169	26,8	24,5	70	10
4170113	13	179	29,0	26,5	88	10
4170114	14	189	31,1	28,0	110	10
4170115	15	199	32,8	29,5	118	10
4170116	16	209	34,3	31,5	134	10
4170117	17	219	36,1	33,0	168	10
4170118	18	229	38,3	34,0	176	10
4170119	19	239	40,3	35,0	204	10

FLEXIBLE RATCHETING WRENCH 6PT.

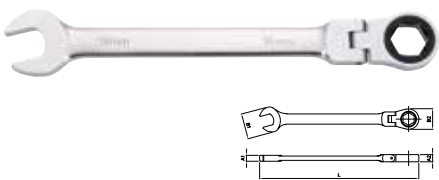

ART. NO.	SIZE	L(MM)	B1(MM)	B2(MM)	G	PCS/BAG
4170608	8	136	16,7	17,4	48	10
4170609	9	158	20,8	20,9	72	10
4170610	10	158	20,8	20,9	70	10
4170611	11	175	25,1	23,4	94	10
4170612	12	175	25,1	23,4	92	10
4170613	13	185	27,1	24,9	116	10
4170614	14	193	29,3	27,4	130	10
4170615	15	213	33,0	30,4	198	10
4170616	16	213	33,0	30,4	194	10
4170617	17	231	35,2	31,9	224	10
4170618	18	249	39,4	34,5	276	10
4170619	19	249	39,4	34,5	270	10

4-IN-1 RING RATCHET WRENCH

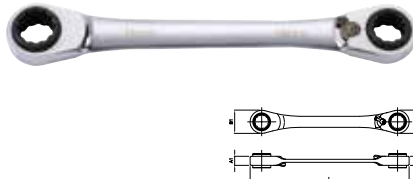

ART. NO.	SIZE	L(MM)	B1(MM)	B2(MM)	G	PCS/BAG
4170401	8-10, 12-12	160	21,5	26,5	98	5
4170402	16-17, 18-19	230	34,5	35,6	264	5

TX RATCHETING WRENCH

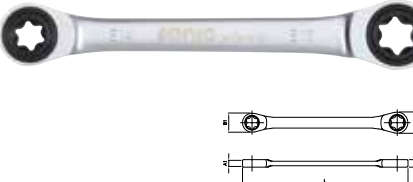

ART. NO.	SIZE	L(MM)	B1(MM)	B2(MM)	G	PCS/BAG
41760608	E6XE8	130,4	17,4	20,9	56	10
41761012	E10XE12	144,4	20,9	22,9	80	10
41761418	E14XE18	181,4	27,4	30,4	154	10
41762024	E20XE24	224,4	31,9	34,4	218	10

45° OFFSET RING WRENCH

DIN NO. 838

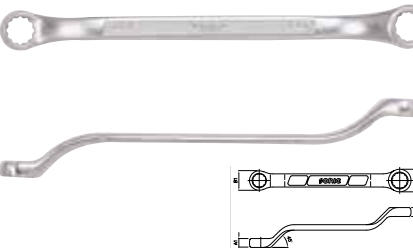

ART. NO.	SIZE	L(MM)	B1(MM)	B2(MM)	G	PCS/BAG
4180607	6X7	165	10,6	13,0	34	10
4180809	8X9	170	14,5	16,5	50	10
4181011	10X11	180	15,0	17,5	68	10
4181213	12X13	206	20,0	22,0	108	10
4181415	14X15	232	22,0	24,0	134	10
4181617	16X17	237	24,0	26,0	160	10
4181819	18X19	270	28,0	29,5	268	10
4182123	21X23	327	32,5	34,5	368	10

75° OFFSET RING WRENCH

DIN NO. 838

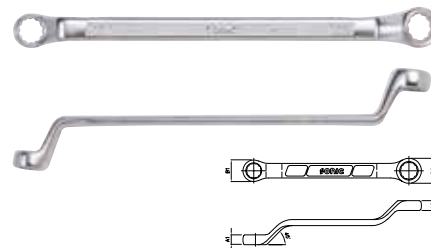

ART. NO.	SIZE	L(MM)	B1(MM)	B2(MM)	G	PCS/BAG
4190607	6X7	168	10,7	12,2	52	10
4190809	8X9	183	13,6	15,1	56	10
4191011	10X11	198	16,6	18,0	94	10
4191213	12X13	217	19,5	20,9	122	10
4191415	14X15	239	22,4	23,7	164	10
4191617	16X17	260	25,3	26,7	196	10
4191819	18X19	292	26,9	28,7	260	10
4192022	20X22	318	34,0	31,1	320	10
4192122	21X22	318	31,1	35,9	382	10
4192123	21X23	330	34,0	35,9	344	10
4192326	23X26	345	36,9	41,4	490	5
4192427	24X27	345	36,9	41,4	498	5
4192528	25X28	355	40,4	43,8	546	5
4193032	30X32	370	45,5	48,5	632	5
4193436	34X36	415	48,5	54,5	1000	5

45° OFFSET RING WRENCH SAE

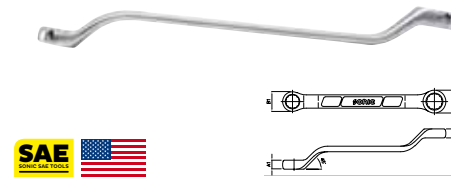

ART. NO.	SIZE	L(MM)	B1(MM)	B2(MM)	G	PCS/BAG
4270608	1/4"x5/16"	165	10,6	13,0	36	5
4271011	3/8"x7/16"	180	15,0	17,5	68	5
4271314	1/2"x9/16"	206	20,0	22,0	100	5
4271416	9/16"x5/8"	232	22,0	25,3	150	5
4271719	11/16"x3/4"	270	28,0	29,5	256	5
4272122	13/16"x7/8"	327	32,5	34,5	368	5
4272425	15/16"x1"	362	34,5	38,5	478	5

INJECTION PUMP WRENCH

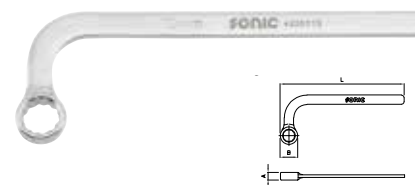

ART. NO.	SIZE	L(MM)	B(MM)	G	PCS/BAG
4200113	13	160	20,6	76	5

FLAT DOUBLE RING WRENCH

DIN NO. 837

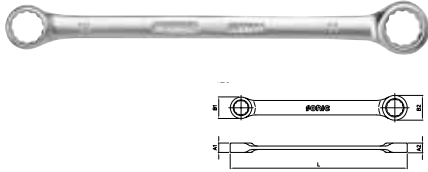

ART. NO.	SIZE	L(MM)	B1(MM)	B2(MM)	G	PCS/BAG
4200607	6X7	119	9,8	11,0	16	5
4200809	8X9	135	12,9	16,5	26	5
4201011	10X11	153	16,5	19,8	44	5
4201213	12X13	162	19,8	22,0	62	5
4201415	14X15	180	22,0	25,0	86	5
4201617	16X17	210	25,0	26,5	118	5
4201819	18X19	225	27,6	28,6	140	5

ANGLE WRENCH 6 PT.

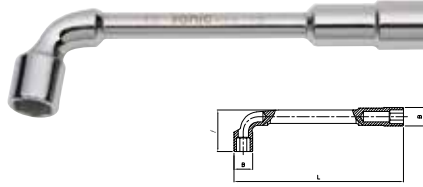

ART. NO.	SIZE	L(MM)	l(MM)	B(MM)	G	PCS/BAG
41308	8	127	29	11,9	68	10
41310	10	140	36	14,8	114	10
41311	11	141	37	15,9	116	10
41312	12	150	42	16,9	152	10
41313	13	153	42	20,0	180	10
41314	14	170	47	20,9	212	10
41315	15	175	48	21,9	226	10
41316	16	195	53	23,9	330	10
41317	17	198	54	25,4	348	10
41318	18	210	57	26,4	400	10
41319	19	213	58	28,4	432	10

TX WRENCH

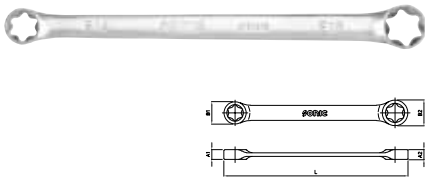

ART. NO.	SIZE	L(MM)	B1(MM)	B2(MM)	G	PCS/BAG
4160608	E6XE8	113	9,2	11,2	22	10
4160711	E7XE11	127	10,6	15,6	24	10
4161012	E10XE12	142	14,4	16,7	42	10
4161418	E14XE18	182	17,2	21,2	82	10
4161622	E16XE22	202	18,9	25,9	116	10
4162024	E20XE24	224	24,8	28,7	200	10

ADJUSTABLE WRENCH



ART. NO.	L(MM)	G	PCS/BAG
42302150	155	147	12
42302200	205	175	6
42301250	255	410	6
42302300	305	765	6
42302375	380	1330	6

HALF-MOON WRENCH

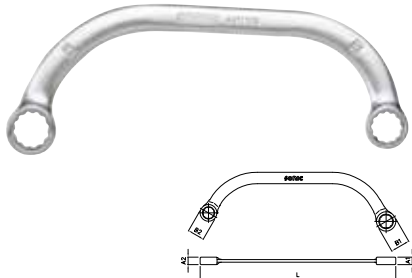

ART. NO.	SIZE	L(MM)	B1(MM)	B2(MM)	G	PCS/BAG
4211012	10X12	141	15,6	18,2	54	5
4211113	11X13	166	18,2	21,0	96	5
4211417	14X17	190	22,0	25,0	128	5

FOR MORE WRENCHES SEE:



SONIC FOAM SYSTEM
PAGE 121



GENERAL TOOLS WRENCHES
PAGE 165

Hex and star keys

INDUSTRIAL FINISHMENT

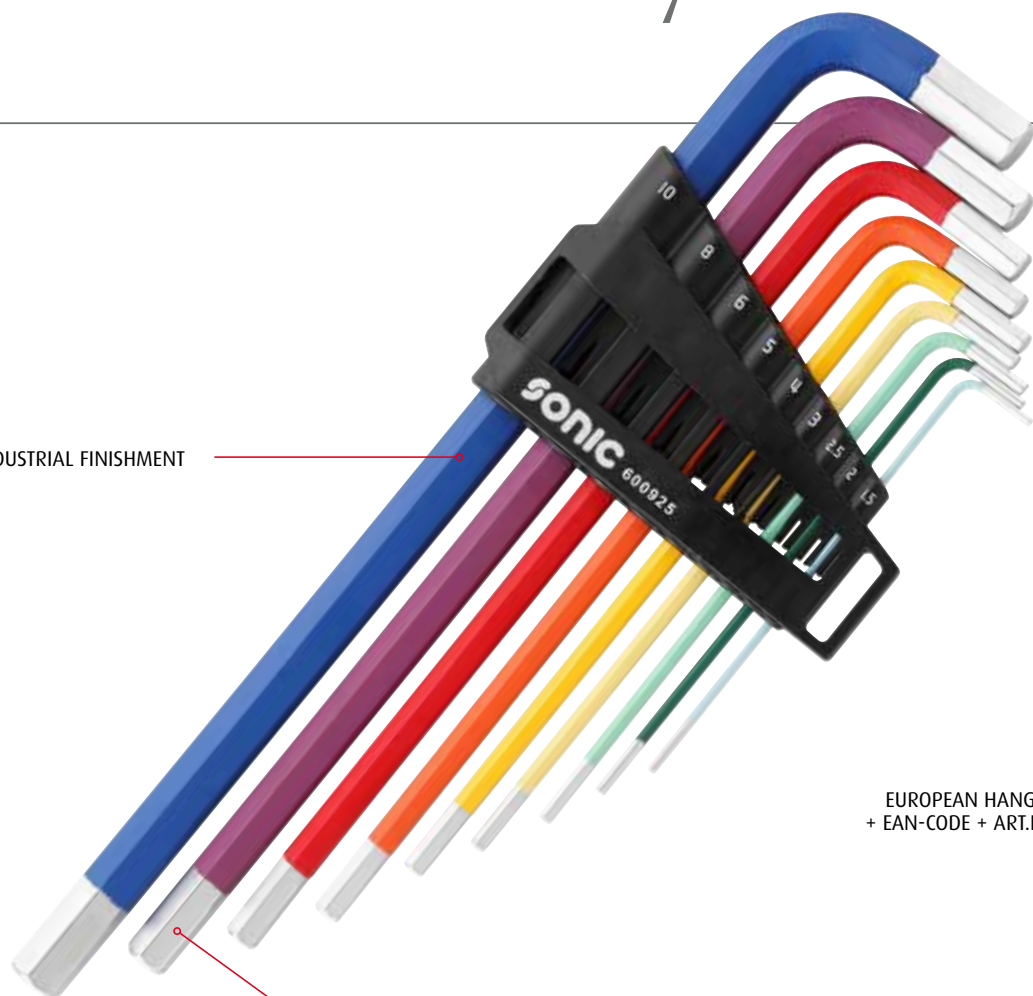

MINIMUM TOLERANCE

EUROPEAN HANGER
+ EAN-CODE + ART.NO



SONIC HAS A WIDE RANGE OF HEX AND TX KEYS. THERE ARE 3 MODELS, METAL HOLDER, PLASTIC HOLDER AND THE CLASSIC L-TYPE.

15



HEX KEY FOLDING WITH METAL HOLDER

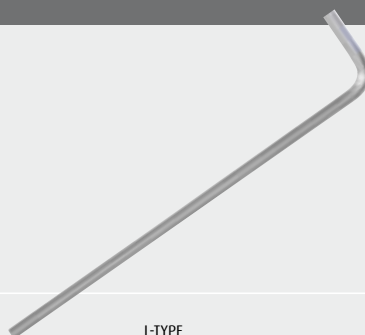

L-TYPE



HEX KEY FOLDING WITH PLASTIC HOLDER, WITH ERGONOMIC GRIP

600713

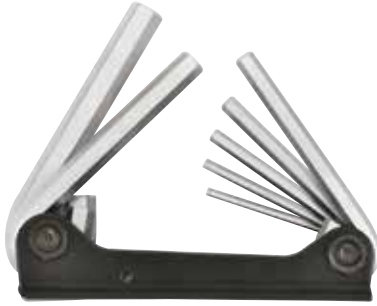

HEX KEY WRENCH SET (FOLDING) 7-PCS

PCS	CONTENTS
7	2.5, 3, 4, 5, 6, 8, 10MM

600712



HEX KEY SET FOLDING 7-PCS (AVAILABLE IN 16-PCS DISPLAY)

PCS	CONTENTS
7	2, 2.5, 3, 4, 5, 6, 8MM

600716



HEX BALL KEY SET FOLDING 7-PCS (AVAILABLE IN 16-PCS DISPLAY)

PCS	CONTENTS
7	2.5, 3, 4, 5, 6, 8, 10MM

600927



HEX KEY WRENCH SET SAE FOLDING 9-PCS (AVAILABLE IN 16-PCS DISPLAY)

PCS	CONTENTS
9	1/16", 5/64", 3/32", 7/64", 1/8", 5/32", 3/16", 7/32", 1/4"

601007



HEXAGON KEY WRENCH, EXTRA LONG SET 10-PCS

ART. NO.	PCS	CONTENTS
184030127...10	10	HEX EXTRA LONG KEY 1.27, 1.5, 2, 2.5, 3, 4, 5, 6, 8, 10MM

600621

600925



EXTRA LONG HEX KEY SET COLOR 9-PCS

PCS	CONTENTS
9	1.5, 2, 2.5, 3, 4, 5, 6, 8, 10MM

600828



EXTRA LONG , 600MML



EXTRA LONG , 600MML

HEX KEY SET, 600MML 6-PCS

PCS	CONTENTS
6	4, 5, 6, 7, 8, 10MM

HEX KEY SET, 600MML 8-PCS

PCS	CONTENTS
8	6, 7, 8, 10, 12, 14, 17, 19MM



600912



HEX BALL STUBBY KEY SET 9-PCS	
PCS	CONTENTS
9	1.5, 2, 2.5, 3, 4, 5, 6, 8, 10MM

601006



HEX BALL LONG KEY SET 10-PCS		
ART. NO.	PCS	CONTENTS
185020127...10	10	HEX BALL LONG KEY 1.27, 1.5, 2, 2.5, 3, 4, 5, 6, 8, 10MM

601008



HEX BALL EXTRA LONG KEY SET 10-PCS		
ART. NO.	PCS	CONTENTS
185030127...10	10	HEX EXTRA LONG KEY 1.27, 1.5, 2, 2.5, 3, 4, 5, 6, 8, 10MM

600918



EXTRA LONG BALL HEX KEY SET, 235MML 9-PCS	
PCS	CONTENTS
9	1.5, 2, 2.5, 3, 4, 5, 6, 8, 10MM

601305



BALL ENDED HEX KEY SET WITH MAGNET, 300MML 13-PCS	
PCS	CONTENTS
13	2, 2.5, 3, 4, 5, 6, 7, 8, 10, 12, 14, 17, 19MM

601306



BALL ENDED HEX KEY SET SAE WITH MAGNET, 300MML 13-PCS	
PCS	CONTENTS
13	5/64, 3/32, 1/8, 5/32, 3/16, 7/32, 1/4, 5/16, 3/8, 1/2, 9/16, 5/8, 3/4"

600923



STUBBY BALL HEX KEY SET COLOR 9-PCS	
PCS	CONTENTS
9	1.5, 2, 2.5, 3, 4, 5, 6, 8, 10MM

600830



STAR KEY SET FOLDING 8-PCS (AVAILABLE IN 16-PCS DISPLAY)

PCS	CONTENTS
8	T8, T10, T15, T20, T25, T27, T30, T40

600813



TX KEY SET (FOLDING) 8-PCS

PCS	CONTENTS
8	TX KEY T8, T10, T15, T20, T25, T27, T30, T40

600924



STUBBY STAR KEY SET COLOR 9-PCS

PCS	CONTENTS
9	T10, T15, T20, T25, T27, T30, T40, T45, T50

600902



TX WRENCH, EXTRA LONG KEY SET 9-PCS

ART. NO.	PCS	CONTENTS
1860310...50	9	TX EXTRA LONG KEY T10, T15, T20, T25, T27, T30, T40, T45, T50

600926



EXTRA LONG STAR KEY SET COLOR 9-PCS

PCS	CONTENTS
9	T10, T15, T20, T25, T27, T30, T40, T45, T50

601307



- MAGNETIC
- EXTREME BIG SIZES

STAR KEY SET WITH MAGNET, 300MML 13-PCS

PCS	CONTENTS
13	T10, T15, T20, T25, T27, T30, T40, T45, T50, T55, T60, T70, T80

600909



TX BALL EXTRA LONG KEY SET 9-PCS

ART. NO.	PCS	CONTENTS
1861310...350	9	TX BALL POINT EXTRA LONG KEY T10, T15, T20, T25, T27, T30, T40, T45, T50

600622



EXTRA LONG, 600MML

STAR KEY SET, 600MML 6-PCS

PCS	CONTENTS
8	T20, T25, T30, T40, T45, T50

601003



HEX KEY WRENCH, EXTRA LONG SET (SAE) 10-PCS

ART. NO.	PCS	CONTENTS
1850601...10	10	HEX EXTRA LONG KEY 1/16", 5/64", 3/32", 1/8", 5/32", 3/16", 7/32", 1/4", 5/16", 3/8"

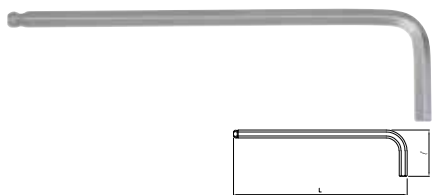
BALL ENDED HEX KEY WRENCH

ART. NO.	SIZE	L(MM)	l(MM)	G	PCS/BAG
185020127	1,27	63	13	2	10
18502015	1,5	63	16	2	10
1850202	2	75	18	2	10
18502025	2,5	88	21	4	10
1850203	3	92	22	6	10
1850204	4	103	29	14	10
1850205	5	118	32	24	10
1850206	6	140	38	40	10
1850208	8	158	44	82	10
1850210	10	180	50	142	10

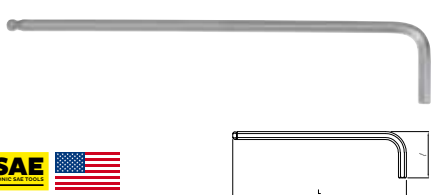
BALL ENDED HEX KEY WRENCH, EXTRA LONG (SAE)

ART. NO.	SIZE	L(MM)	l(MM)	G	PCS/BAG
1850601	1/16"	81	13	2	10
1850602	5/64"	92	16	2	10
1850603	3/32"	102	18	4	10
1850604	1/8"	115	21	6	10
1850605	5/32"	129	22	8	10
1850606	3/16"	144	29	18	10
1850607	7/32"	165	32	30	10
1850608	1/4"	185	38	50	10
1850609	5/16"	208	44	98	10
1850610	3/8"	232	50	176	10

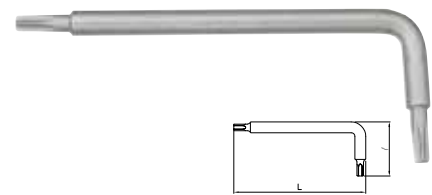
KEY WRENCH TX, EXTRA LONG

ART. NO.	SIZE	L(MM)	l(MM)	G	PCS/BAG
1860106	T6	45	20	2	10
1860107	T7	50	20	4	10
1860108	T8	51	20	4	10
1860109	T9	53	18	4	10

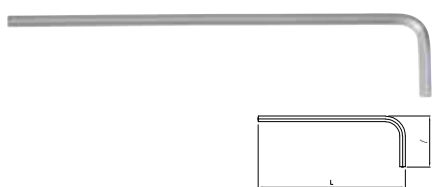
HEX KEY WRENCH, EXTRA LONG

ART. NO.	SIZE	L(MM)	l(MM)	G	PCS/BAG
184030127	1,27	81	13	2	10
18403015	1,5	92	16	2	10
1840302	2	102	18	2	10
18403025	2,5	115	21	6	10
1840303	3	129	22	8	10
1840304	4	144	29	18	10
1840305	5	165	32	32	10
1840306	6	185	38	50	10
1840308	8	208	44	102	10
1840310	10	232	50	176	10

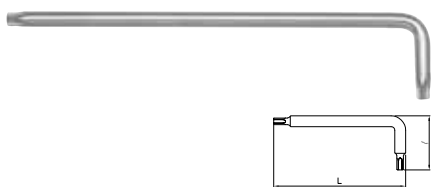
STAR EXTRA KEY WRENCH TX, EXTRA LONG KEY

ART. NO.	SIZE	L(MM)	l(MM)	G	PCS/BAG
1860310	T10	92	16	6	10
1860315	T15	102	18	8	10
1860320	T20	115	21	12	10
1860325	T25	129	22	18	10
1860327	T27	144	29	26	10
1860330	T30	165	32	40	10
1860340	T40	186	38	62	10
1860345	T45	208	44	90	10
1860350	T50	232	50	128	10

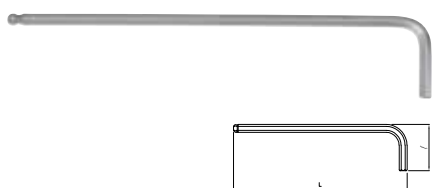
BALL ENDED HEX KEY WRENCH, EXTRA LONG

ART. NO.	SIZE	L(MM)	l(MM)	G	PCS/BAG
185030127	1,27	81	13	2	10
18503015	1,5	92	16	2	10
1850302	2	102	18	4	10
18503025	2,5	115	21	6	10
1850303	3	129	22	8	10
1850304	4	144	29	18	10
1850305	5	165	32	30	10
1850306	6	185	38	50	10
1850308	8	208	44	98	10
1850310	10	232	50	176	10

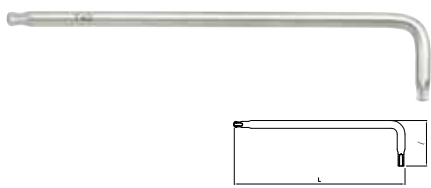
BALL ENDED KEY WRENCH TX, EXTRA LONG

ART. NO.	SIZE	L(MM)	l(MM)	G	PCS/BAG
1861310	T10	92	16	4	10
1861315	T15	102	18	8	10
1861320	T20	115	21	12	10
1861325	T25	129	22	18	10
1861327	T27	144	29	24	10
1861330	T30	165	32	38	10
1861340	T40	185	38	60	10
1861345	T45	208	44	88	10
1861350	T50	232	50	124	10



Pliers, hammers, chisels, files, measuring and cutting tools

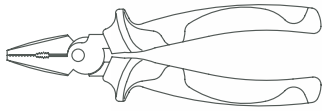

PRECISION-HARDENED
PLIERS HEAD FOR
ON-THE-JOB TOUGHNESS

ERGONOMICALLY
DESIGNED TWO
COMPONENT HANDLE

SONIC PLIERS FEATURE AN ERGONOMIC DESIGN TO GET THE JOB DONE QUICKLY, EFFICIENTLY AND COMFORTABLY. QUALITY FORGED STEEL ENSURES STRENGTH AND TOUGHNESS. HANDLES ARE DESIGNED TO INCREASE LEVERAGE AND STRENGTH WITHOUT SACRIFICING THE USER COMFORT.



DIAGONAL
PLIERS



COMBINATION
PLIERS



LONG NOSE
PLIERS



BENT LONG NOSE
PLIERS



SNAP RING PLIERS
STRAIGHT-OPEN



SNAP RING PLIERS
STRAIGHT-CLOSE



SNAP RING
PLIERS BENT-OPEN



SNAP RING
PLIERS BENT-CLOSE

Hammers

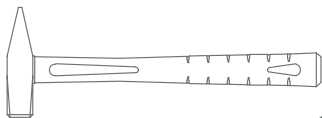

PRECISION HEAT
TREATMENT OF THE HEAD
AND HIGH QUALITY FACE
FINISH COMBINED TO
ENHANCE SAFETY

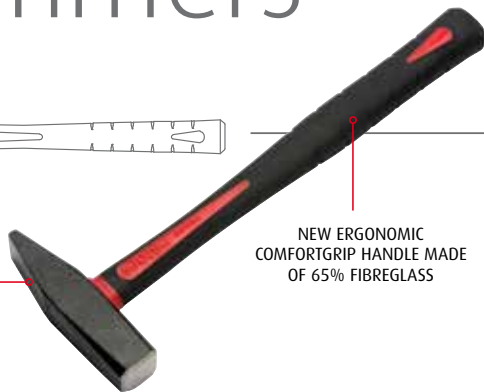

NEW ERGONOMIC
COMFORTGRIP HANDLE MADE
OF 65% FIBREGLASS

Grip chisel

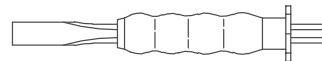

SHEATED, SHOCK -
ABSORBING HANDLE, WITH
PERFECT GRIP. IT OFFERS
MAXIMUM COMFORT AND SAFETY

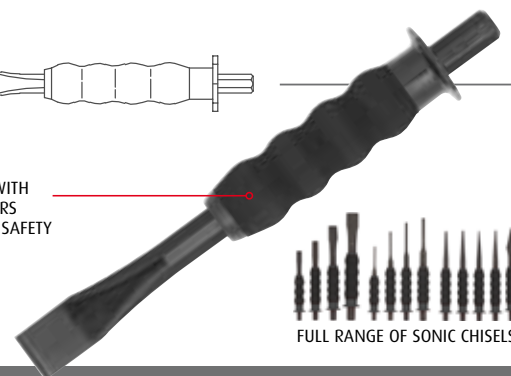

FULL RANGE OF SONIC CHISELS

SONIC OFFERS YOU THE LATEST FIBREGLASS HAMMERS WITH ERGONOMIC TPR COVER. SONIC HAS MACHINIST HAMMERS FROM 200GR, 400GR AND 1000GR STONING HAMMER.

SEMI SPHERICAL STRIKING AREA CONTROLS MUSHROOMING. PRODUCED FROM SPECIAL ALLOY STEEL WITH DIFFERENT HEAT TREATMENT PROCESS TO HELP TOUGHNESS. THE ERGONOMIC SOFT GRIP HANDLE PROVIDES A POWERFUL GRIP, IMPROVES THE THERMAL SENSATION IN COLD WORK ENVIRONMENTS AND REDUCES STRIKE VIBRATION.

COMBINATION PLIERS 6"

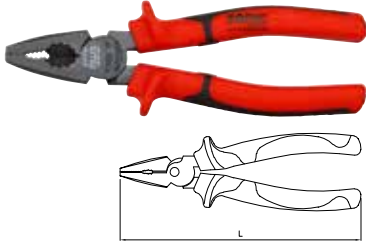

ART. NO.	L(MM)	G	PCS/BAG
4311165	165	190	6

LONG NOSE PLIERS 6"

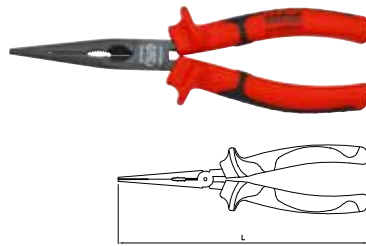

ART. NO.	L(MM)	G	PCS/BAG
4322160	170	152	6

DIAGONAL PLIERS 5"

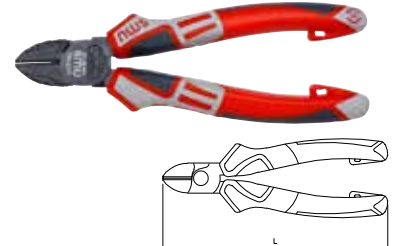

ART. NO.	L(MM)	G	PCS/BAG
4341145	155	158	6

COMBINATION PLIERS 7"

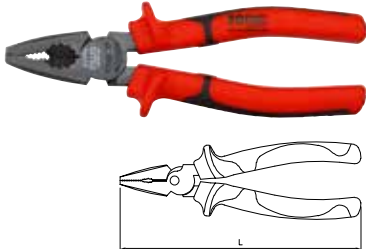

ART. NO.	L(MM)	G	PCS/BAG
4311175	185	240	10

LONG NOSE PLIERS 6"

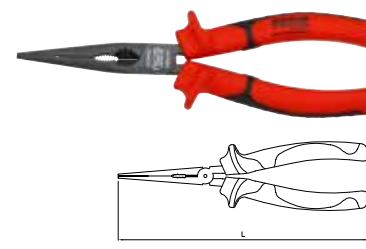

ART. NO.	L(MM)	G	PCS/BAG
4321170	170	156	6

DIAGONAL PLIERS 7"

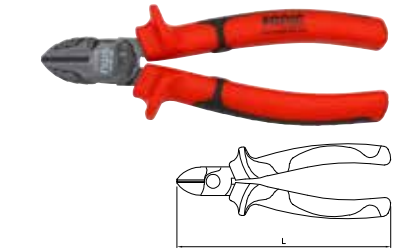

ART. NO.	L(MM)	G	PCS/BAG
4341175	165	214	10

ERGONOMIC POWER-COMBINATION PLIERS 8"

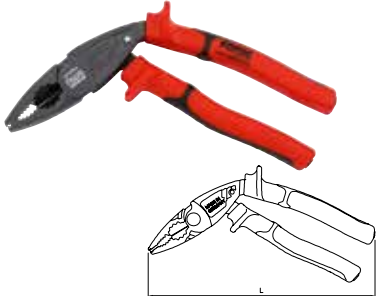

ART. NO.	L(MM)	G	PCS/BAG
4312200	200	295	10

LONG NOSE PLIERS 8"

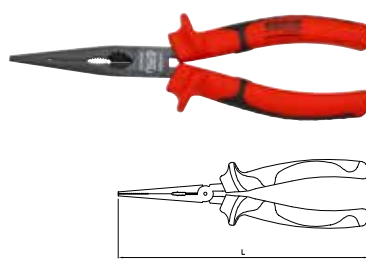

ART. NO.	L(MM)	G	PCS/BAG
4321200	205	218	10

DIAGONAL PLIERS 7"

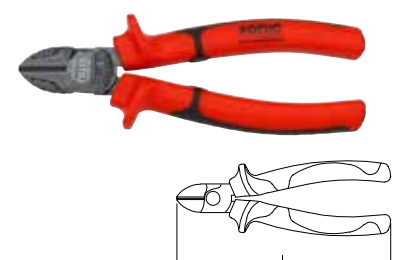

ART. NO.	L(MM)	G	PCS/BAG
4341180	185	250	6

VDE COMBIMAX PLIERS

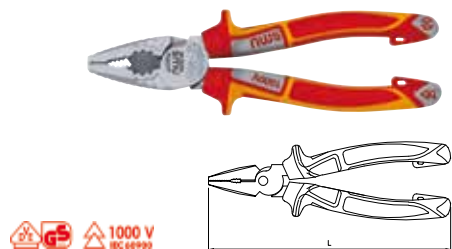

ART. NO.	L(MM)	G	PCS/BAG
4312180	185	260	10

VDE TELEPHONE PLIERS 200

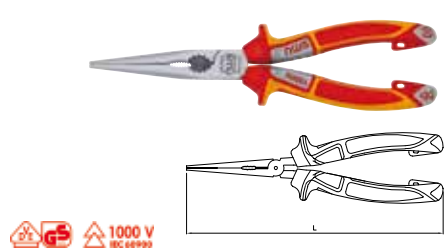

ART. NO.	L(MM)	G	PCS/BAG
4322200	205	220	10

UNIVERSALE DIAGONAL PLIERS 190MM

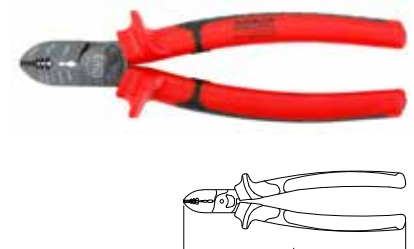

ART. NO.	L(MM)	G	PCS/BAG
4341190	190	245	6

LONG NOSE PLIERS 6"

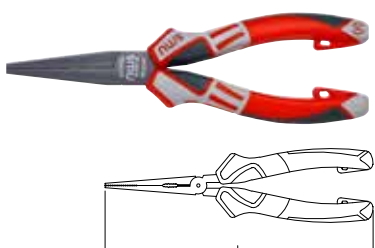

ART. NO.	L(MM)	G	PCS/BAG
4321160	170	152	6

BENT LONG NOSE PLIERS 8"

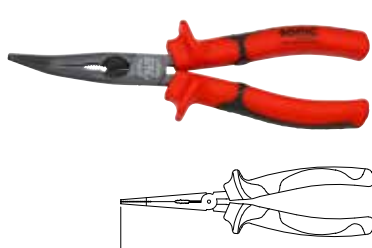

ART. NO.	L(MM)	G	PCS/BAG
4331200	195	202	10

LEVERAGE DIAGONAL PLIERS 8"

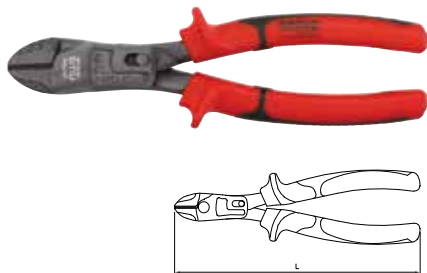

ART. NO.	L(MM)	G	PCS/BAG
4342200	200	340	10

LEVERAGE DIAGONAL PLIERS 9"

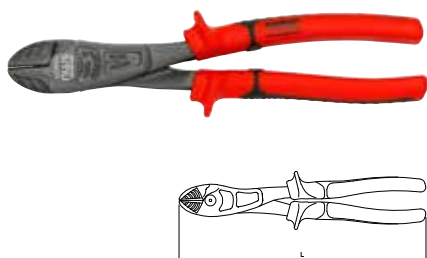

ART. NO.	L(MM)	G	PCS/BAG
4342240	240	420	10

HEAVY DUTY SIDE PLIERS 8"

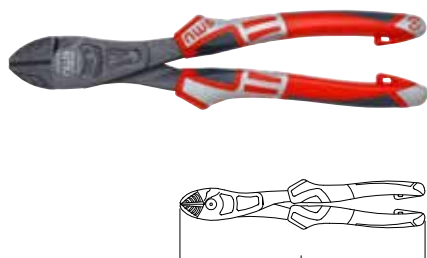

ART. NO.	L(MM)	G	PCS/BAG
4343200	210	290	6

VDE SIDE CUTTER 160

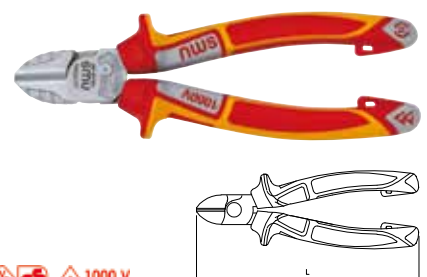

ART. NO.	L(MM)	G	PCS/BAG
4342160	165	210	10

VDE STRIPPING PLIERS 160

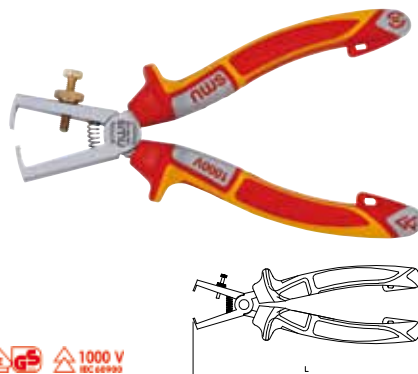

ART. NO.	L(MM)	G	PCS/BAG
4472160	160	185	10

WIRE STRIPPER 8"

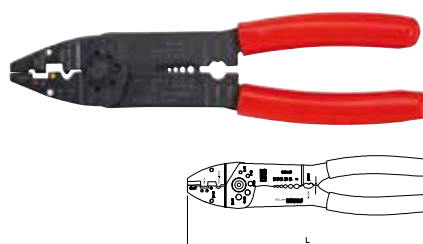

ART. NO.	L(MM)	G	PCS/BAG
4471250	215	186	10

AUTOMATIC WIRE STRIPPER 0.5 - 4 MM



ART. NO.	L(MM)	G	PCS/BAG
4471180	180	130	10

WIRE STRIPPER 0.2-6.0MM



ART. NO.	L(MM)	G	PCS/BAG
813003	280	316	1

- STRIPPING AND CUTTING OF CABLES AND WIRES WITH 0,05-6MM², ADJUSTABLE BY SETTING WHEEL
- CRIMPING OF 0,2-6MM² ISOLATED CABLE SHOES
- CRIMPING OF 0,2-6MM² UNINSULATED CABLE SHOES
- CRIMPING OF 7-8MM² IGNITION CABLE CONTACTS
- WITH ONE OPERATION EACH POSITION OF THE CABLE CAN BE STRIPPED

WATERPUMP PLIERS 10"

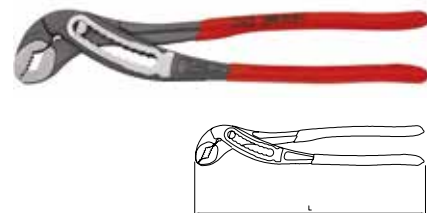

ART. NO.	L(MM)	G	PCS/BAG
4351180	180	145	10
4351250	250	322	10
4351300	300	580	10
4351400	400	1305	10

WATERPUMP PLIERS MX, 250MM 10"

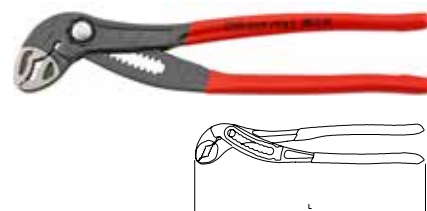

ART. NO.	L(MM)	G	PCS/BAG
4352250	250	340	10

TOWER PINCERS 280MML

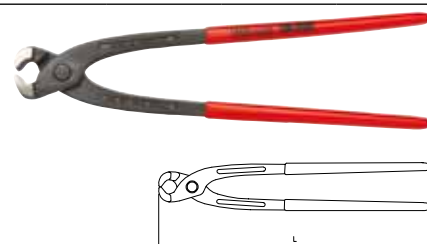

ART. NO.	L(MM)	G	PCS/BAG
44601280	280	436	1

SNAP RING PLIERS (STRAIGHT OPEN)

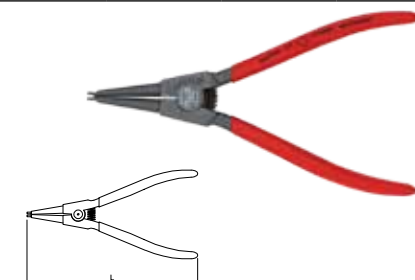

ART. NO.	L(MM)	G	PCS/BAG
43611	178	150	10

SNAP RING PLIERS (STRAIGHT CLOSE)

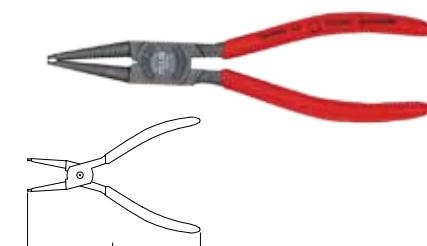

ART. NO.	L(MM)	G	PCS/BAG
43612	178	150	10

SNAP RING PLIERS (BENT OPEN)

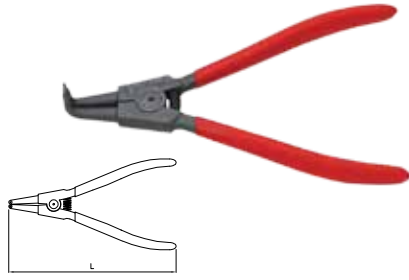

ART. NO.	L(MM)	G	PCS/BAG
43613	167	150	10

LONG NOSE PLIERS 11" 45° BENT

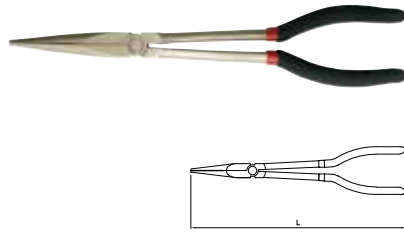

ART. NO.	L(MM)	G	PCS/BAG
4333275	275	287	5

GLOW PLUG PLIERS BENT

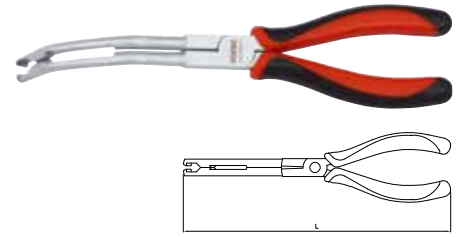

ART. NO.	L(MM)	G	PCS/BAG
4476004	240	240	10

SNAP RING PLIERS (BENT CLOSE)

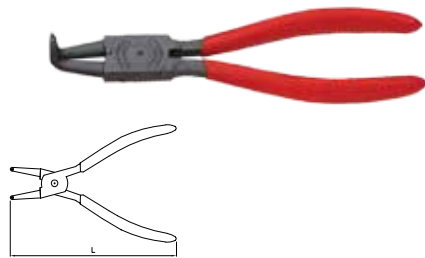

ART. NO.	L(MM)	G	PCS/BAG
43614	167	150	10

CIRCLE NOSE PLIERS 11"

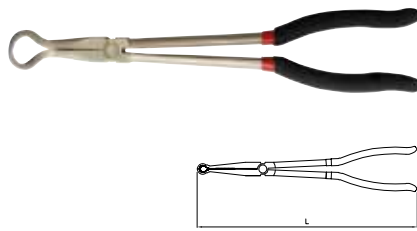

ART. NO.	L(MM)	G	PCS/BAG
4393001	291	313	5
4393002	291	321	5
4393003	295	317	5

SPARK PLUG PLIERS

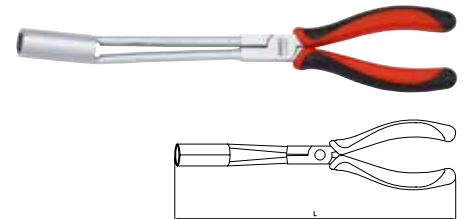

ART. NO.	L(MM)	G	PCS/BAG
4476005	290	302	10

LONG NOSE PLIERS STRAIGHT 11"

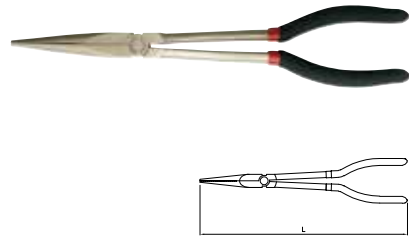

ART. NO.	L(MM)	G	PCS/BAG
4323275	284	295	5

SCISSOR JOINTED PLIERS, EXTRA LONG

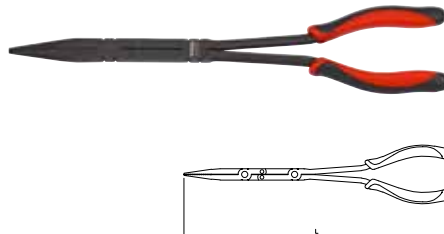

ART. NO.	L(MM)	G	PCS/BAG
4476006	340	396	10

SPARK PLUG CONNECTOR PLIERS

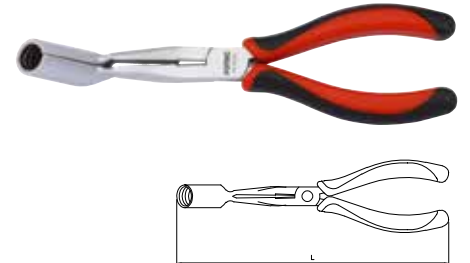

ART. NO.	L(MM)	G	PCS/BAG
4476002	290	267	10

LONG NOSE PLIERS 10" 90° BENT

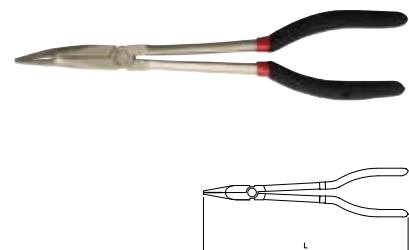

ART. NO.	L(MM)	G	PCS/BAG
4333270	257	290	5

SCISSOR JOINTED PLIERS, EXTRA LONG 45° BENT

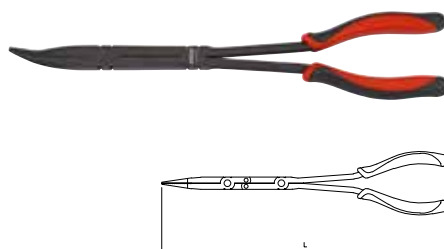

ART. NO.	L(MM)	G	PCS/BAG
4476007	336	396	10

SPARK PLUG CONNECTOR PLIERS (RING)

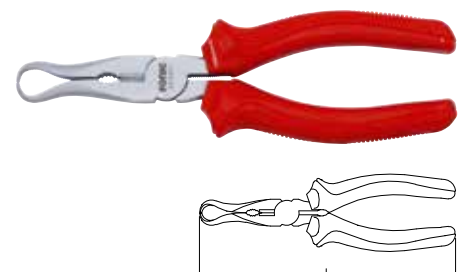

ART. NO.	L(MM)	G	PCS/BAG
4476001	290	240	10

LOCKING PLIERS 10"

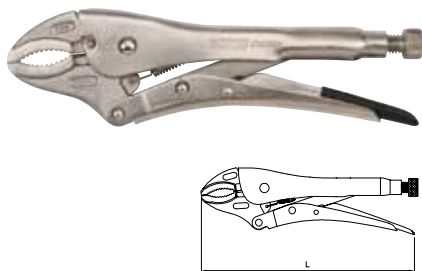

ART. NO.	L(MM)	G	PCS/BAG
4380250	230	570	10

V CURVED JAW LOCKING PLIERS

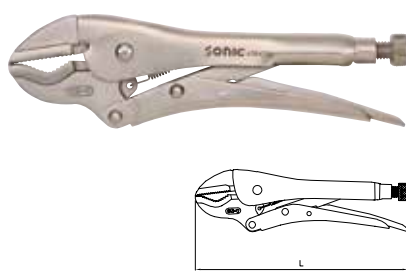

ART. NO.	L(MM)	G	PCS/BAG
4384250	230	572	10

WELDER'S GRIP PLIERS

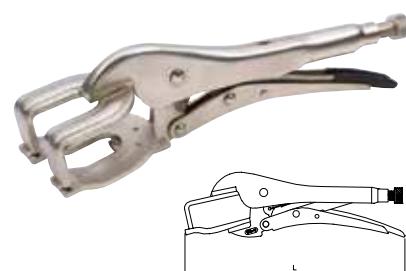

ART. NO.	L(MM)	G	PCS/BAG
4388275	270	864	5

LONG NOSE LOCKING PLIERS

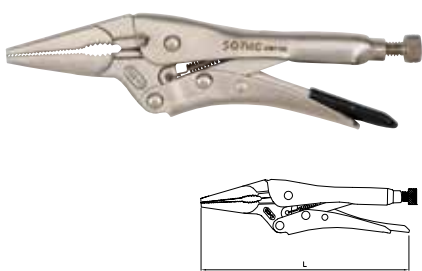

ART. NO.	L(MM)	G	PCS/BAG
4381150	170	190	5
4381225	220	376	5

PAD LOCKING C CLAMP PLIERS

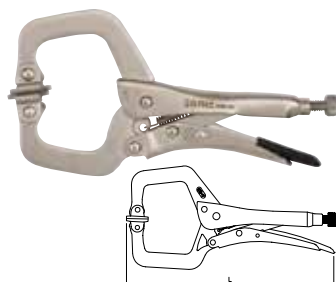

ART. NO.	L(MM)	G	PCS/BAG
4385150	175	274	5
4385275	285	798	5

LOCKING PLIERS FOR BRAKE AND AIR PLUG

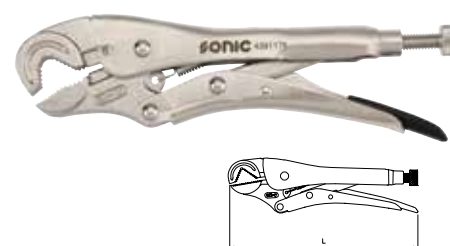

ART. NO.	L(MM)	G	PCS/BAG
4391175	200	366	5

CURVED JAW LOCKING PLIERS

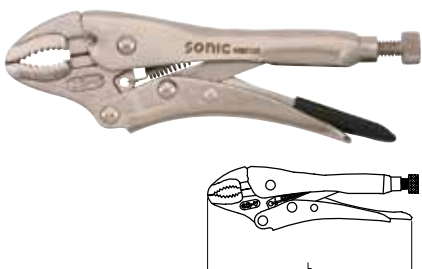

ART. NO.	L(MM)	G	PCS/BAG
4382125	145	178	5
4382175	190	345	5
4382250	225	552	5

DOT LOCKING C CLAMP

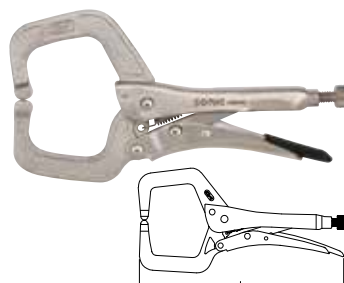

ART. NO.	L(MM)	G	PCS/BAG
4386150	170	232	5
4386275	275	802	5

HOSE CLAMP PLIERS

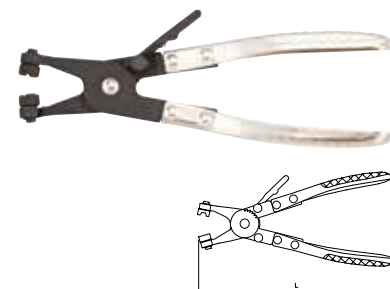

ART. NO.	L(MM)	G	PCS/BAG
4473001	215	208	1

STRAIGHT JAW LOCKING PLIERS

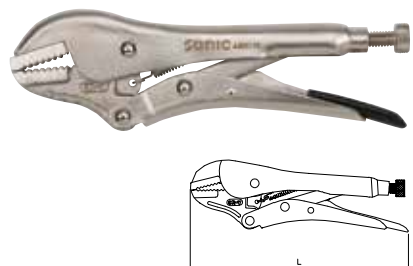

ART. NO.	L(MM)	G	PCS/BAG
4383175	190	376	5
4383250	230	578	5

LOCKING PLIERS 10"

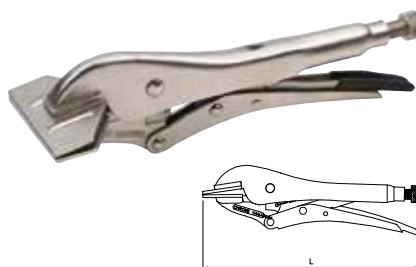

ART. NO.	L(MM)	G	PCS/BAG
4387250	245	708	5

FLAT BAND HOSE CLAMP PLIERS

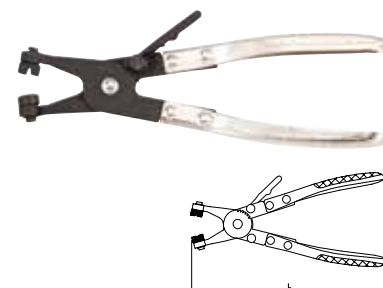

ART. NO.	L(MM)	G	PCS/BAG
4473002	215	208	1

ANGLED FLAT BAND HOSE CLAMP PLIERS

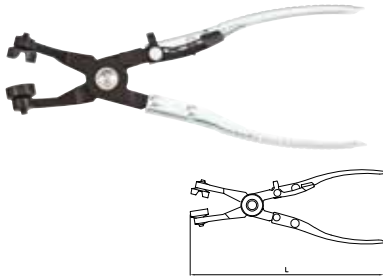

ART. NO.	L(MM)	G	PCS/BAG
4473004	215	186	1

HOSE CLIP PLIER

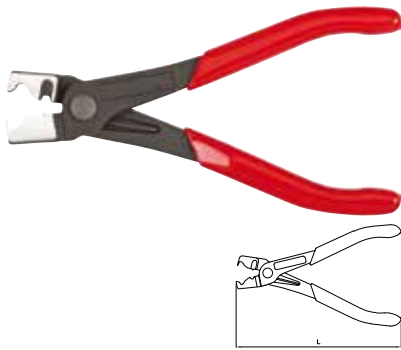

ART. NO.	L(MM)	G	PCS/BAG
4473003	175	228	1

HOSE CLAMP PLIER (ANGLE TYPE)

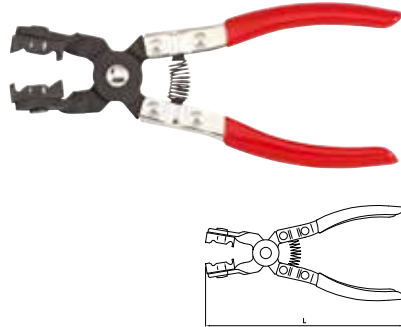

ART. NO.	L(MM)	G	PCS/BAG
4473005	180	244	1

WHEEL WEIGHT BALANCE PLIERS 10"

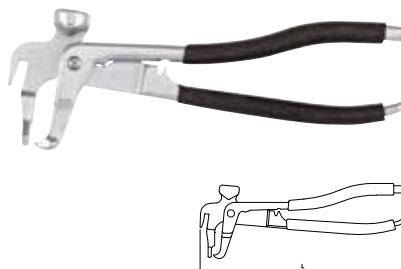

ART. NO.	L(MM)	G	PCS/BAG
4474001	240	394	1

WHEEL ADHESIVE BALANCE WEIGHT PLIERS



ART. NO.	L(MM)	G	PCS/BAG
4474002	230	536	1

RIVETING PLIERS 10.5"

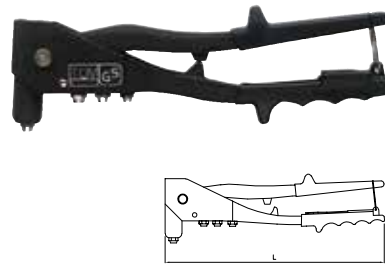

ART. NO.	L(MM)	G	PCS/BAG
4410265	260	480	24

OIL FILTER PLIERS

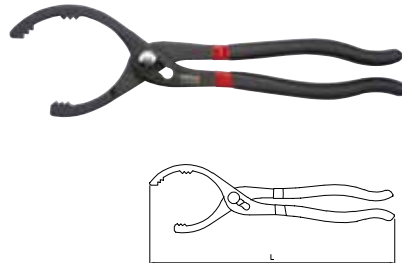

ART. NO.	L(MM)	G	PCS/BAG
4450250	260	396	5
4450300	305	466	5

600624



PIN PUNCH SET 6-PCS

ART. NO.	PCS	CONTENTS
4532115...8180	6	PIN PUNCH 115MML 2, 125MML 3, 150MML 4, 165MML 5, 180MML 6, 180MML 8

ART. NO.	L(MM)	G	PCS/BAG
4532115	115	50	10
4532125	125	54	10
4532150	150	88	10
4532165	165	102	10
4532180	180	182	10
4532180	180	176	10

GRIP CHISEL

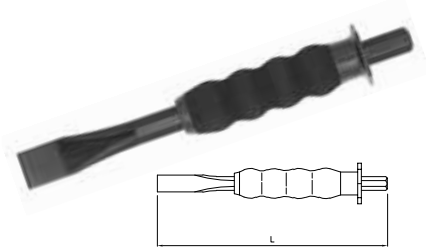

ART. NO.	L(MM)	G	PCS/BAG
45110141	140	60	10
45112160	160	96	10
45116170	170	116	10
45118190	190	196	10
45124220	220	350	10

GRIP CAPE CHISEL

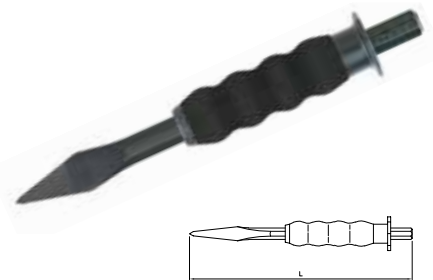

ART. NO.	L(MM)	G	PCS/BAG
4527190	190	186	10

FLAT CHISEL

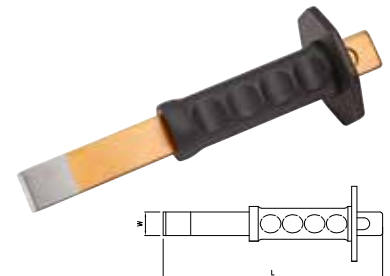

ART. NO.	L(MM)	G	PCS/BAG
4831101	240	370	1

GRIP PIN PUNCH

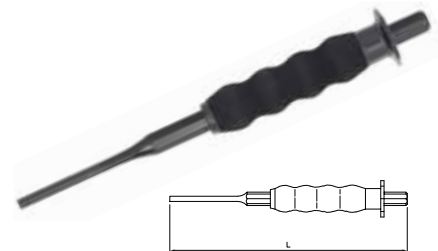

ART. NO.	L(MM)	G	PCS/BAG
4532140	140	50	10
4533150	150	54	10
4534180	180	88	10
4535200	200	102	10
4536210	210	182	10
4538220	220	176	10

GRIP TAPER PUNCH

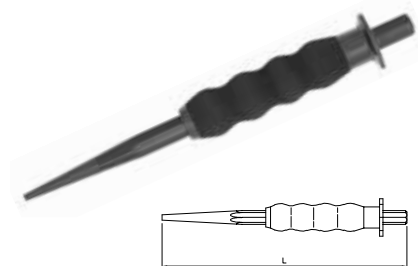

ART. NO.	L(MM)	G	PCS/BAG
4552185	185	98	10
4553185	185	100	10
4554185	185	102	10

GRIP CENTER PUNCH



ART. NO.	L(MM)	G	PCS/BAG
4564185	185	102	10

AUTO CENTER PUNCH



ART. NO.	L(MM)	W(MM)	G	PCS/BAG
45602	155	37	134	10

MACHINIST HAMMER FIBRE HANDLE TPR COVER 200GR

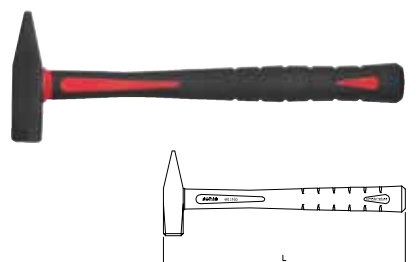

ART. NO.	L(MM)	G	PCS/BAG
4611200	287	322	5

MACHINIST HAMMER FIBRE HANDLE TPR COVER 400GR

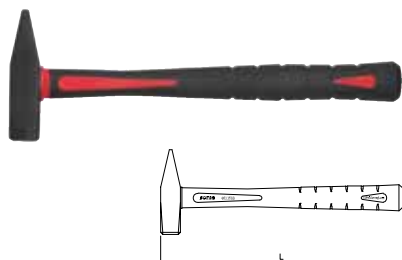

ART. NO.	L(MM)	G	PCS/BAG
4611400	311	520	5

MACHINIST HAMMER 1000GR

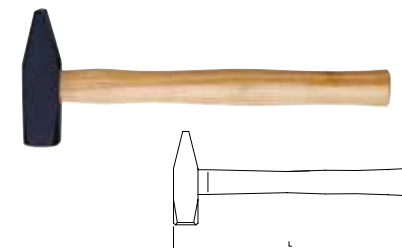

ART. NO.	L(MM)	G	PCS/BAG
4621000	366	1276	5

STONING HAMMER FIBRE HANDLE TPR COVER 1000GR

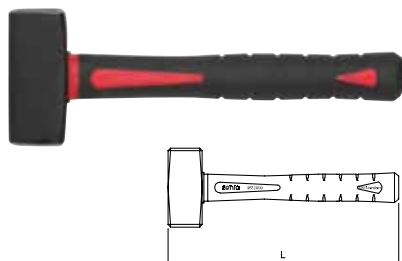

ART. NO.	L(MM)	G	PCS/BAG
4631000	278	1334	5

SAND FILLED HAMMER 400GR

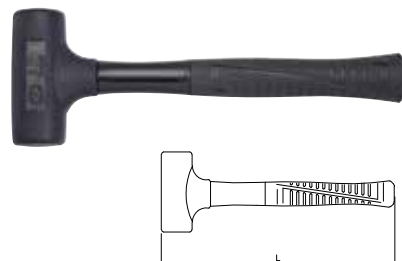

ART. NO.	L(MM)	G	PCS/BAG
4620400	290	488	5

35MM INSTALL HAMMER SOFT/HARD



ART. NO.	L(MM)	G	PCS/BAG
4822102	317	472	6

HACKSAW

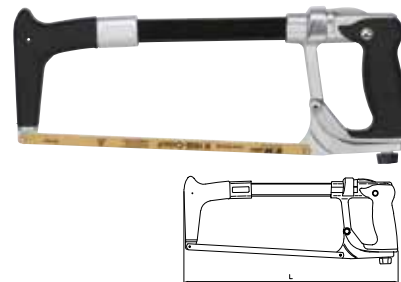

ART. NO.	L(MM)	G	PCS/BAG
46601	415	962	5

MINI HACKSAW



ART. NO.	L(MM)	G	PCS/BAG
46602	270	218	10
46603	153	8	10

SHEARS



ART. NO.	TYPE	L(MM)	G	PCS/BAG
46702	LEFT	185	210	5
46703	RIGHT	185	210	5

SHEARS

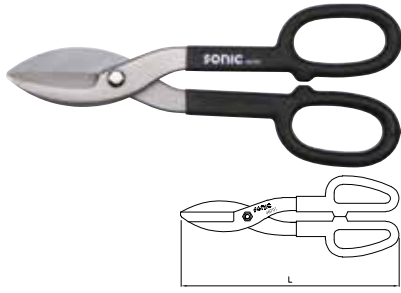

ART. NO.	L(MM)	G	PCS/BAG
46701	262	484	5

UTILITY KNIFE (INCL. 10 BLADES)

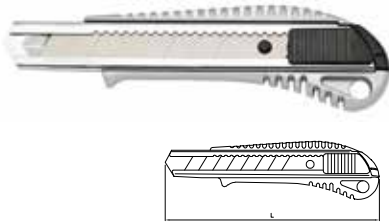

ART. NO.	L(MM)	G	PCS/BAG
46806	157	134	10

10-PCS SPARE BLADES IN HOLDER FOR UTILITY KNIFE 46806



ART. NO.	L(MM)	G	PCS/BAG
46806-1	119	76	100

UTILITY KNIFE (INCL. 13 BLADES)

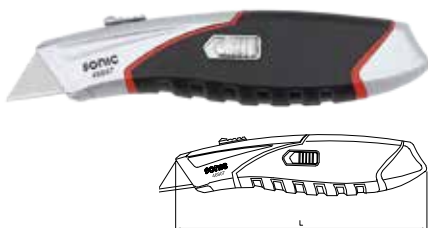

ART. NO.	L(MM)	G	PCS/BAG
46807	164	184	10

10-PCS SPARE BLADES IN HOLDER FOR UTILITY KNIFE 46807

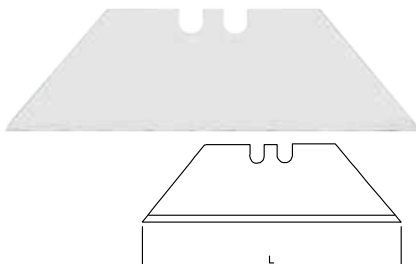

ART. NO.	L(MM)	G	PCS/BAG
46807-1	68	48	100

UNIVERSAL KNIFE

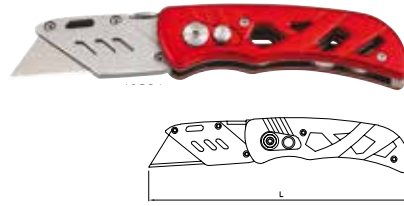

ART. NO.	L(MM)	G	PCS/BAG
46804	155	144	8

ALSO AVAILABLE IN DISPLAY WITH 8-PCS



SPARE BLADES (46802 IN HOLDER)

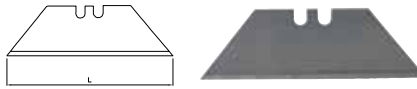

ART. NO.	L(MM)	G	PCS/BAG
46803	61	48	100

FLAT FILE 8"

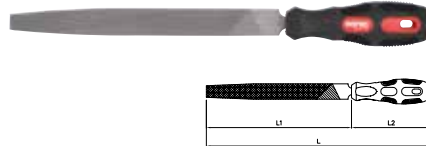

ART. NO.	L1(MM)	L2(MM)	L(mm)	G	PCS/BAG
46901	205	110	315	185	10

FLAT FILE 8"

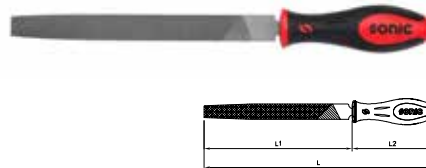

ART. NO.	L1(MM)	L2(MM)	L(mm)	G	PCS/BAG
46911	205	115	320	190	10

HALF ROUND FILE 8"

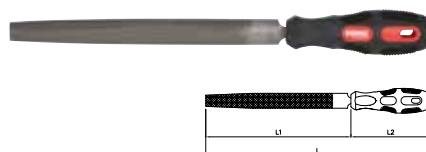

ART. NO.	L1(MM)	L2(MM)	L(mm)	G	PCS/BAG
46902	205	110	315	174	10

HALF ROUND FILE 8"

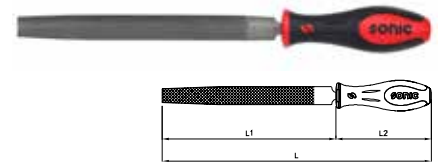

ART. NO.	L1(MM)	L2(MM)	L(mm)	G	PCS/BAG
46912	205	115	320	206	10

ROUND FILE 8"

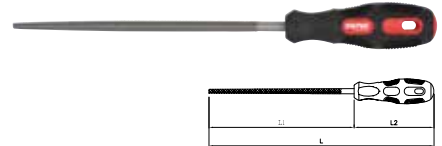

ART. NO.	L1(MM)	L2(MM)	L(mm)	G	PCS/BAG
46903	205	110	315	128	10

ROUND FILE 8"

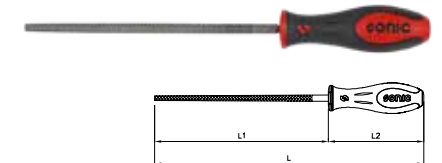

ART. NO.	L1(MM)	L2(MM)	L(mm)	G	PCS/BAG
46913	205	115	320	138	10

TRIANGULAR FILE 8"

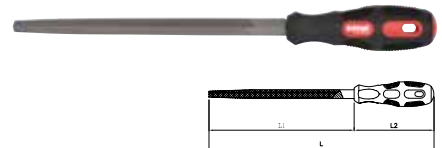

ART. NO.	L1(MM)	L2(MM)	L(mm)	G	PCS/BAG
46904	205	110	315	154	10

TRIANGULAR FILE 8"

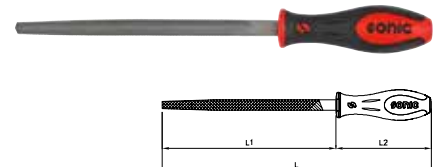

ART. NO.	L1(MM)	L2(MM)	L(mm)	G	PCS/BAG
46914	205	115	320	188	10

TRIANGULAR FILE FOR BRAKES 8"

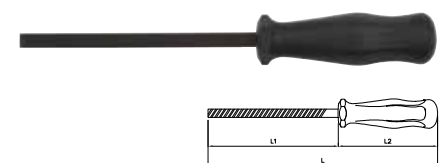

ART. NO.	L1(MM)	L2(MM)	L(mm)	G	PCS/BAG
46905	155	115	270	170	10

TRIANGULAR HOLLOW SHAPE SCRAPER

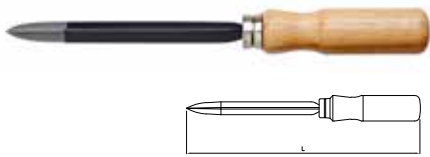

ART. NO.	L(MM)	G	PCS/BAG
47824	275	122	10

STAINLESS STEEL STRAIGHT RULE (30CM)

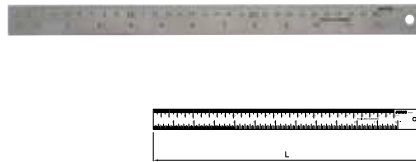

ART. NO.	L(MM)	G	PCS/BAG
47004	330	50	10

TIRE PROFILE GAUGE 50MM

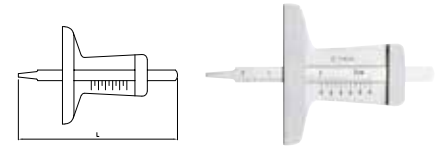

ART. NO.	L(MM)	W(MM)	G	PCS/BAG
47028	90	55	38	10

STEEL WIRE BRUSH



ART. NO.	L(MM)	G	PCS/BAG
4811254	225	65	10

- MAX. WIDTH STEEL WIRE BRUSH 8,5 MM
- MAX. WIDTH PLASTIC HOLDER 12,5 MM
- LENGTH BRUSH 90 MM
- ALSO AVAILABLE IN DISPLAY WITH 12-PCS



STAINLESS STEEL PROTRACTOR

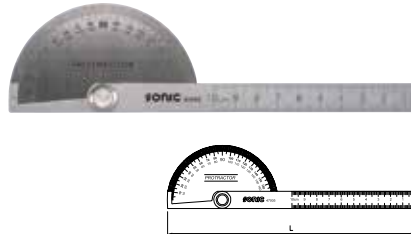

ART. NO.	L(MM)	G	PCS/BAG
47005	200	64	10

DIGITAL VERNIER CALIPER

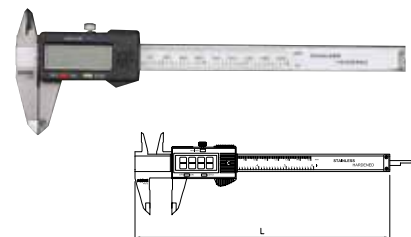

ART. NO.	L(MM)	G	PCS/BAG
47010	235	158	10

STAINLESS STEEL VERNIER CALIPER

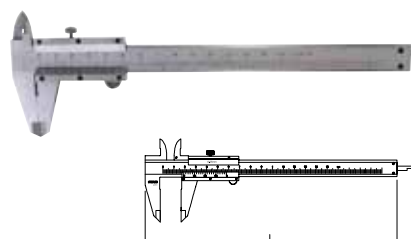

ART. NO.	L(MM)	G	PCS/BAG
47003	230	150	6

STAINLESS STEEL VERNIER CALIPER FOR DISC BRAKES



ART. NO.	L(MM)	A(MM)	B(MM)	G	PCS/BAG
47024	175	50	54	226	1

MEASURING TAPE 5M



ART. NO.	L(MM)	G	PCS/BAG
47013	81	112	12

SPECIAL DESIGNED STOP BUTTON, OFFERS MORE COMFORT AND ANTI-FATIGUE

DOOR UPHOLSTERY PANEL REMOVER

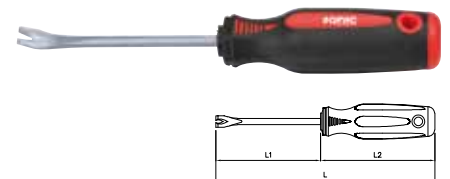

ART. NO.	L1(MM)	L2(MM)	L(MM)	G	PCS/BAG
47801	100	109	209	88	10

DOOR UPHOLSTERY PANEL REMOVER

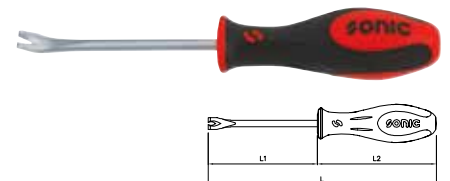

ART. NO.	L1(MM)	L2(MM)	L(MM)	G	PCS/BAG
47901	100	115	215	106	10

DOOR UPHOLSTERY PANEL REMOVER

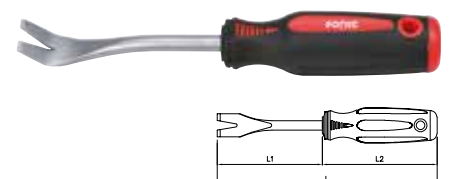

ART. NO.	L1(MM)	L2(MM)	L(MM)	G	PCS/BAG
47802	110	119	229	160	10

BRASS WIRE BRUSH



ART. NO.	L(MM)	G	PCS/BAG
4811260	235	58	10

FEELER GAUGE 26-PCS

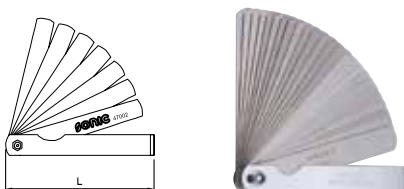

ART. NO.	L(MM)	G	PCS/BAG
47002	92	86	10

FEELER GAUGE 20-PCS

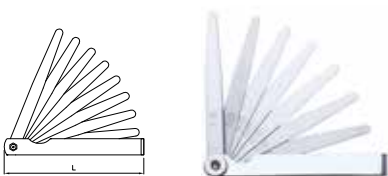

ART. NO.	L(MM)	G	PCS/BAG
47006	108	92	10

DOOR UPHOLSTERY PANEL REMOVER

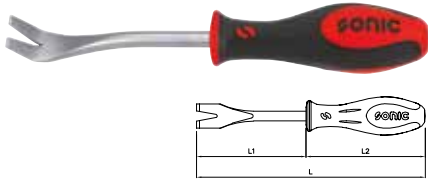

ART. NO.	L1(MM)	L2(MM)	L(MM)	G	PCS/BAG
47902	110	124	234	169	10

SCRAPER

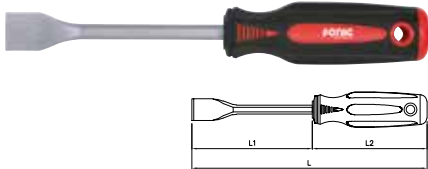

ART. NO.	L1(MM)	L2(MM)	L(MM)	G	PCS/BAG
47803	125	119	244	146	10

SCRAPER

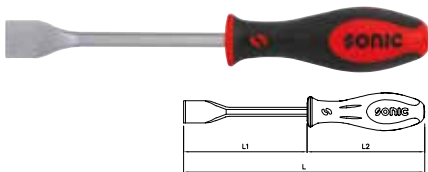

ART. NO.	L1(MM)	L2(MM)	L(MM)	G	PCS/BAG
47903	125	124	249	155	10

PLASTIC SCRAPER

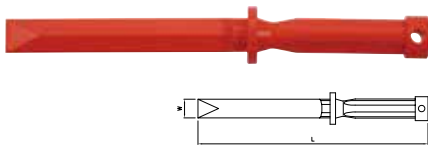

ART. NO.	L(MM)	W(MM)	H(MM)	G	PCS/BAG
47817	260	37	37	82	1

TRIM REMOVAL

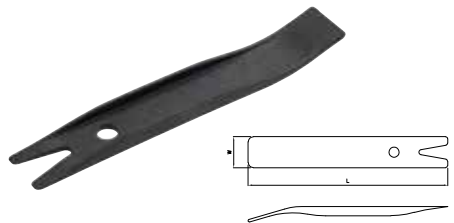

ART. NO.	L(MM)	W(MM)	H(MM)	G	PCS/BAG
47825	190	30	12.5	28	1

STICKER SCRAPER

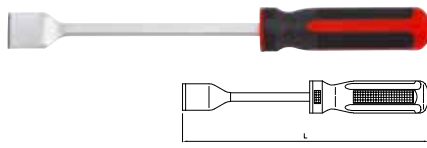

ART. NO.	L(MM)	W(MM)	H(MM)	G	PCS/BAG
47818	280	30	30	152	10

SEAL SCRAPER

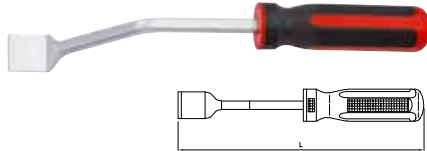

ART. NO.	L(MM)	W(MM)	H(MM)	G	PCS/BAG
47819	280	75	30	156	10

ANGLE SCRAPER

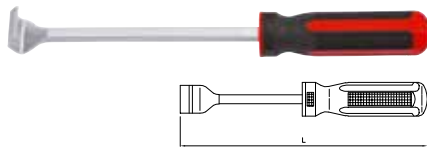

ART. NO.	L(MM)	W(MM)	H(MM)	G	PCS/BAG
47820	265	30	30	158	10

COTTER PIN PULLER



ART. NO.	L1(MM)	L2(MM)	L(MM)	G	PCS/BAG
47804	125	109	234	98	10

COTTER PIN PULLER

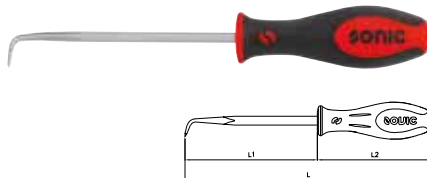

ART. NO.	L1(MM)	L2(MM)	L(MM)	G	PCS/BAG
47904	125	115	240	116	10

RADIATOR HOSE REMOVER

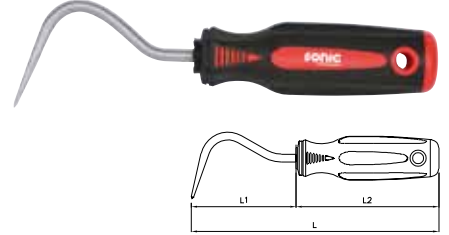

ART. NO.	L1(MM)	L2(MM)	L(MM)	G	PCS/BAG
47805	80	109	189	88	10

RADIATOR HOSE REMOVER

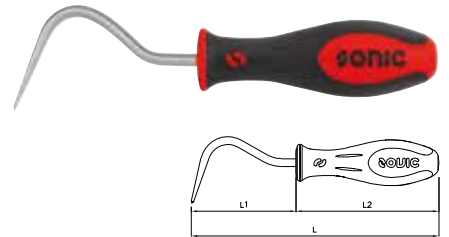

ART. NO.	L1(MM)	L2(MM)	L(MM)	G	PCS/BAG
47905	80	115	195	106	10

TRIM PAD TOOL

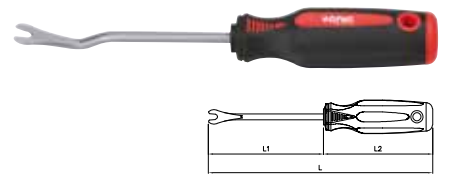

ART. NO.	L1(MM)	L2(MM)	L(MM)	G	PCS/BAG
47806	115	109	224	92	10

TRIM PAD TOOL

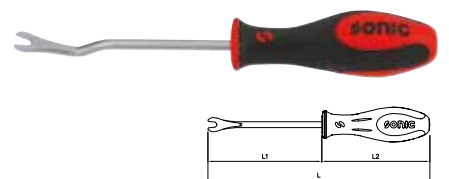

ART. NO.	L1(MM)	L2(MM)	L(MM)	G	PCS/BAG
47906	115	115	230	110	10

TRIM PAD TOOL

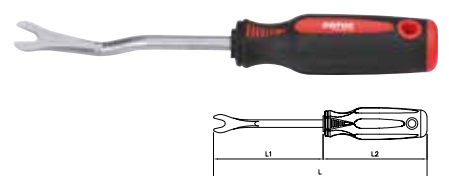

ART. NO.	L1(MM)	L2(MM)	L(MM)	G	PCS/BAG
47807	115	109	224	116	10

TRIM PAD TOOL

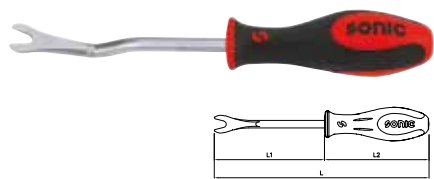

ART. NO.	L1(MM)	L2(MM)	L(MM)	G	PCS/BAG
47907	115	124	239	134	10

FULL HOOK



ART. NO.	L1(MM)	L2(MM)	L(MM)	G	PCS/BAG
47911	135	115	250	112	10

MINI DEGREE HOOK

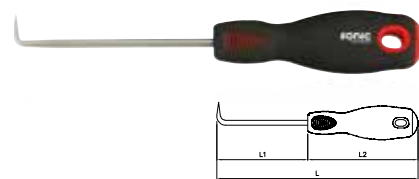

ART. NO.	L1(MM)	L2(MM)	L(MM)	G	PCS/BAG
47810	70	73	143	20	10

DOOR UPHOLSTERY PANEL REMOVER

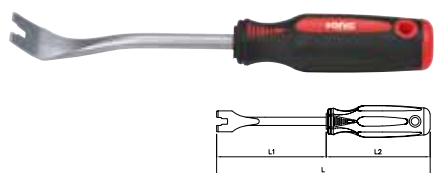

ART. NO.	L1(MM)	L2(MM)	L(MM)	G	PCS/BAG
47808	132	119	251	174	10

SMALL ANGLE HOOK



ART. NO.	L1(MM)	L2(MM)	L(MM)	G	PCS/BAG
47912	135	115	250	110	10

MINI DEGREE HOOK



ART. NO.	L1(MM)	L2(MM)	L(MM)	G	PCS/BAG
47830	70	92	162	30	10

DOOR UPHOLSTERY PANEL REMOVER

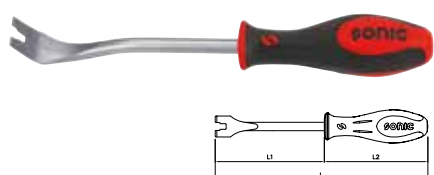

ART. NO.	L1(MM)	L2(MM)	L(MM)	G	PCS/BAG
47908	132	124	256	183	10

HOOK FOR EXHAUST RUBBER RINGS



ART. NO.	L(MM)	G	PCS/BAG
47814	235	100	48

MINI FULL HOOK

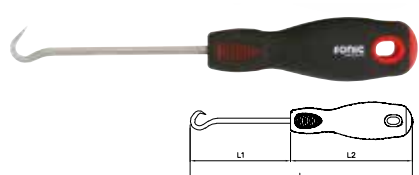

ART. NO.	L1(MM)	L2(MM)	L(MM)	G	PCS/BAG
47811	70	73	143	20	10

STRAIGHT PICK HOOK



ART. NO.	L1(MM)	L2(MM)	L(MM)	G	PCS/BAG
47909	135	115	250	108	10

MINI STRAIGHT PICK

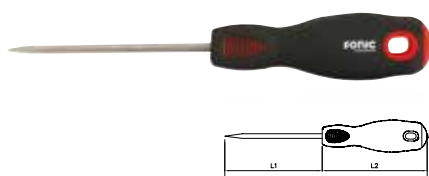

ART. NO.	L1(MM)	L2(MM)	L(MM)	G	PCS/BAG
47809	70	73	143	20	10

MINI FULL HOOK

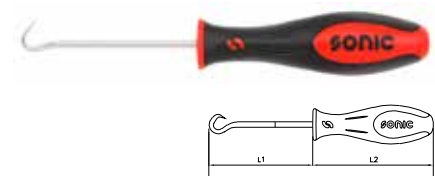

ART. NO.	L1(MM)	L2(MM)	L(MM)	G	PCS/BAG
47831	70	92	162	30	10

DEGREE HOOK



ART. NO.	L1(MM)	L2(MM)	L(MM)	G	PCS/BAG
47910	135	115	250	112	10

MINI STRAIGHT PICK HOOK



ART. NO.	L1(MM)	L2(MM)	L(MM)	G	PCS/BAG
47829	70	92	162	30	10

MINI SMALL ANGLE HOOK

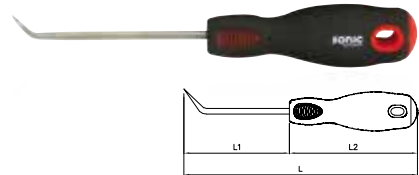

ART. NO.	L1(MM)	L2(MM)	L(MM)	G	PCS/BAG
47812	70	73	143	20	10

MINI SMALL ANGLE HOOK

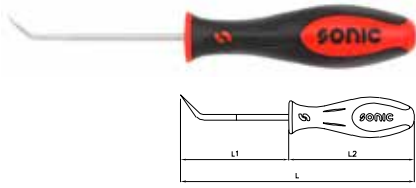

ART. NO	L1(MM)	L2(MM)	L(MM)	G	PCS/BAG
47832	70	92	162	30	10

MAGNET PICKUP

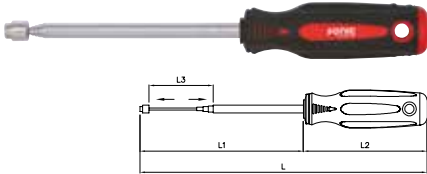

ART. NO.	L1(MM)	L3(MM)	L2(MM)	L(MM)	G	PCS/BAG
4820101	90	465	70	160-535	35	10

MAGNET PICKUP (10 LBS.)

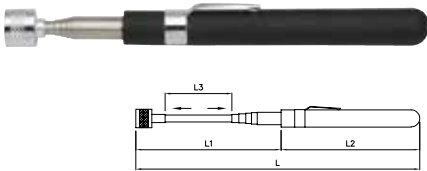

ART. NO.	L1(MM)	L3(MM)	L2(MM)	L(MM)	G	PCS/BAG
4820110	75	650	120	195-770	58	5

EXTENDABLE MAGNET PICKUP 2,8 KG

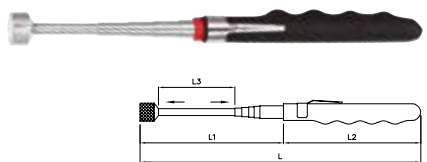

ART. NO.	L1(MM)	L3(MM)	L2(MM)	L(MM)	G	PCS/BAG
4820106	30	490	130	160-620	60	16

• ALSO AVAILABLE IN DISPLAY WITH 16 PCS



FLEXIBLE MAGNETIC PICKUP 500GR

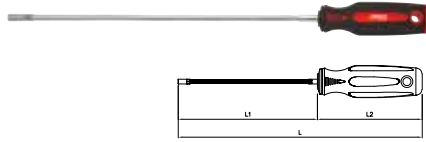

ART. NO.	L1(MM)	L2(MM)	L(MM)	G	PCS/BAG
4820107	300	109	409	118	5

FLEXIBLE MAGNET PICKUP 500GR.

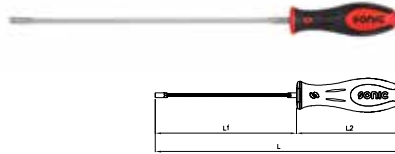

ART. NO.	L1(MM)	L2(MM)	L(MM)	G	PCS/BAG
4820207	300	115	415	120	5

TELESCOPIC MIRROR 30-74CM

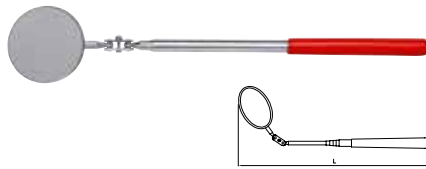

ART. NO.	L(MM)	G	PCS/BAG
4820111	318-618	76	10

PRY BAR



ART. NO.	L1(MM)	L2(MM)	L(MM)	G	PCS/BAG
4820308	95	109	204	102	5
4820312	185	119	304	246	5
4820318	335	119	454	440	5
4820324	491	119	610	600	5

PRY BAR



ART. NO.	L1(MM)	L2(MM)	L(MM)	G	PCS/BAG
4821308	90	115	205	108	5
4821312	180	125	305	254	5
4821318	330	125	455	456	5
4821324	435	125	560	596	5

BENT PRY BAR 8"

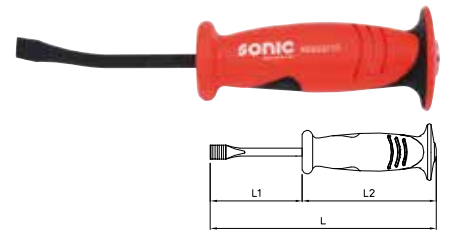

ART. NO.	L1(MM)	L2(MM)	L(MM)	G	PCS/BAG
48203210	88	121	209	146	10

BENT FORKED PRY BAR 12"

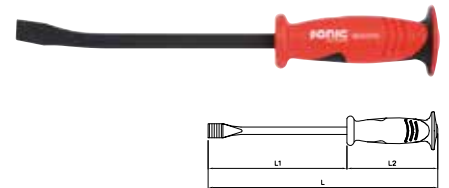

ART. NO.	L1(MM)	L2(MM)	L(MM)	G	PCS/BAG
48203300	192	121	313	284	10

ELBOW BENT PRY BAR 18"

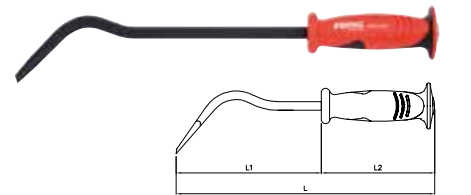

ART. NO.	L1(MM)	L2(MM)	L(MM)	G	PCS/BAG
48203460	325	144	469	538	5

EXTENDED PRY BAR 24"

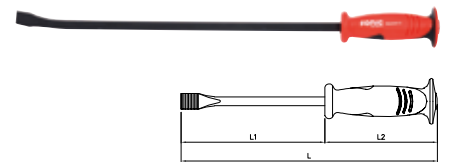

ART. NO.	L1(MM)	L2(MM)	L(MM)	G	PCS/BAG
48203610	466	144	610	682	5

Ratchets

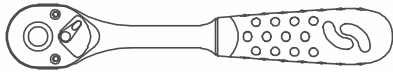

EUROPEAN HANGER + EAN-CODE + ART. NO.



ERGONOMIC SANTOPRENE THERMOPLASTIC HANDLE

SONIC HAS A WIDE VARIETY OF RATCHETS IN RANGE



QUICK RELEASE



SLIM FIT



QUICK RELEASE SYSTEM. SIMPLY PRESS THE BUTTON TO RELEASE THE SOCKET, EVEN WITH SLIPPERY HANDS



RATCHETS FOR TIGHT SPACES



1/4" AND 3/8" DISC RATCHETS

SONIC HAS A WIDE VARIETY OF RATCHETS IN HER PRODUCT LINE WHICH EXISTS OF DIFFERENT MODELS. RANGING FROM 1/4", 3/8", 1/2", 3/4" TO 1".



45 TEETH REVERSIBLE RATCHET HANDLE WITH QRS



72 TEETH REVERSIBLE COMPACT-HEAD RATCHET HANDLE



72 TEETH REVERSIBLE ROTOR RATCHET



45 TEETH FLEXIBLE REVERSIBLE RATCHET HANDLE WITH QRS



48 TEETH RAPID RATCHET HANDLE WITH ROTATABLE HEAD

WORK EFFICIENT
WORK WITH SONIC

RATCHET HANDLE - 45 TEETH

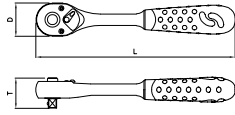

ART. NO.	SIZE	L(MM)	T(MM)	D(MM)	G	PCS/BAG
7120901	1/4"	140	23	26	122	10
7120902	3/8"	195	30	33	298	10
7120903	1/2"	255	37	43	590	5

STUBBY RATCHET - 45 TEETH

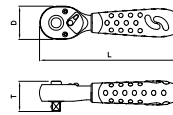

ART. NO.	SIZE	L(MM)	T(MM)	D(MM)	G	PCS/BAG
7120101	1/4"	110	23	26	106	10
7120102	3/8"	118	30	33	192	10

ROTOR RATCHET - 72 TEETH

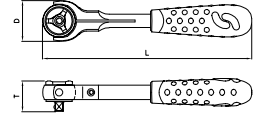

ART. NO.	SIZE	L(MM)	T(MM)	D(MM)	G	PCS/BAG
7110201	1/4"	150	24	32	130	10
7110202	3/8"	235	34	44	385	10
7110203	1/2"	305	40	49	652	10

REPAIR SET

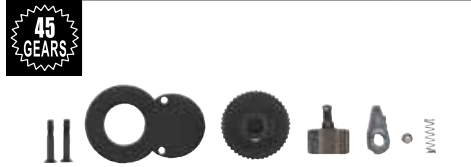

ART. NO.	DESCRIPTION	PCS/BAG
7120901P	REPAIR SET RATCHET 7120101 & 7120901	1
7120902P	REPAIR SET RATCHET 7120102 & 7120902	1
7120903P	REPAIR SET RATCHET 7120903	1

REPAIR SET



ART. NO.	DESCRIPTION	PCS/BAG
7120901P	REPAIR SET RATCHET 7120101 & 7120901	1
7120902P	REPAIR SET RATCHET 7120102 & 7120902	1

REPAIR SET



ART. NO.	DESCRIPTION	PCS/BAG
7110201P	REPAIR SET RATCHET 7110201	1
7110202P	REPAIR SET RATCHET 7110202 & 7110402	1
7110203P	REPAIR SET RATCHET 7110203 & 7110403	1

RATCHET HANDLE - 72 TEETH

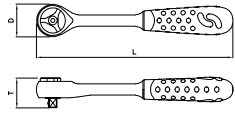

ART. NO.	SIZE	L(MM)	T(MM)	D(MM)	G	PCS/BAG
7120701	1/4"	145	24	26	112	10
7120702	3/8"	195	30	30	212	10
7120703	1/2"	248	38	38	456	5

FLEXIBLE RATCHET - 45 TEETH

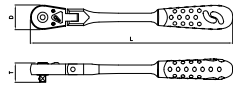
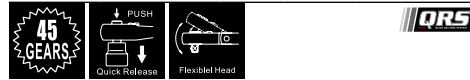

ART. NO.	SIZE	L(MM)	T(MM)	D(MM)	G	PCS/BAG
7110101	1/4"	133	23	26	142	10
7110102	3/8"	265	30	33	418	10
711013300	1/2"	300	37	43	724	5
711013440	1/2"	440	37	43	932	5

ROTOR HEAD STUBBY RATCHET - 72 TEETH

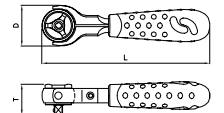

ART. NO.	SIZE	L(MM)	T(MM)	D(MM)	G	PCS/BAG
7110402	3/8"	155	34	44	278	10
7110403	1/2"	182	40	49	472	10

REPAIR SET



ART. NO.	DESCRIPTION	PCS/BAG
7120701P	REPAIR SET RATCHET 7120701	1
7120702P	REPAIR SET RATCHET 7120702	1
7120703P	REPAIR SET RATCHET 7120703	1

REPAIR SET



ART. NO.	DESCRIPTION	PCS/BAG
7110101P	REPAIR SET RATCHET 7110101	1
7110102P	REPAIR SET RATCHET 7110102	1
711013P	REPAIR SET RATCHET 711013300 & 711013440	1

REPAIR SET



ART. NO.	DESCRIPTION	PCS/BAG
7110202P	REPAIR SET RATCHET 7110202 & 7110402	1
7110203P	REPAIR SET RATCHET 7110203 & 7110403	1

RAPID RATCHET HANDLE (W/Q) - 48 TEETH



ART. NO.	SIZE	L(MM)	T(MM)	D(MM)	G	PCS/BAG
7110501	1/4"	175	21	23	205	10
7110502	3/8"	243	23	30	350	10
7110503	1/2"	310	36	39	710	5

REPAIR SET

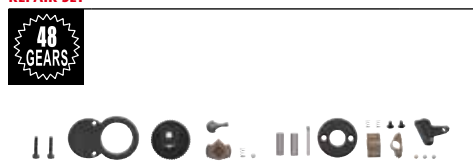

ART. NO.	DESCRIPTION	PCS/BAG
7110501P	REPAIR SET RATCHET 7110501	1
7110502P	REPAIR SET RATCHET 7110502	1
7110503P	REPAIR SET RATCHET 7110503	1

EXTENDABLE RATCHET - 72 TEETH

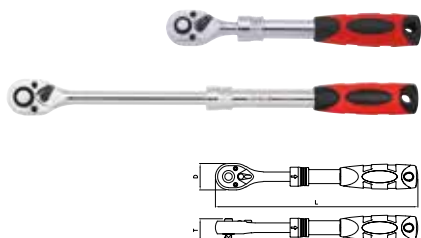

ART. NO.	SIZE	L(MM)	T(MM)	D(MM)	G	PCS/BAG
7120301	1/4"	150-200	23,0	25,0	172	5
7120302	3/8"	215-315	33,0	32,0	436	5
7120303	1/2"	305-445	40,0	40,0	918	5

REPAIR SET

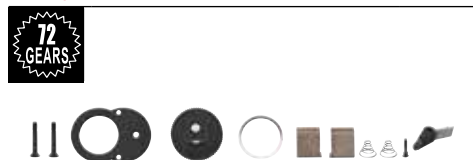

ART. NO.	DESCRIPTION	PCS/BAG
7120301P	REPAIR SET RATCHET 7120301	1
7120302P	REPAIR SET RATCHET 7120302	1
7120303P	REPAIR SET RATCHET 7120303	1

DISC RATCHET - 72 TEETH



ART. NO.	SIZE	T(MM)	D(MM)	G	PCS/BAG
7110301	1/4"	25	49	50	10
7110302	3/8"	28	49	58	10

REPAIR SET



ART. NO.	DESCRIPTION	PCS/BAG
7110301P	REPAIR SET RATCHET 7110301	1
7110302P	REPAIR SET RATCHET 7110302	1

RATCHET HANDLE - 24 TEETH

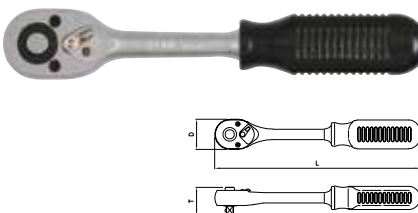

ART. NO.	SIZE	L(MM)	T(MM)	D(MM)	G	PCS/BAG
7120201	1/4"	153	22	27	156	10
7120202	3/8"	214	30	36	336	10
7120203	1/2"	274	40	47	700	5

REPAIR SET



ART. NO.	DESCRIPTION	PCS/BAG
7120201P	REPAIR SET RATCHET 7120201	1
7120202P	REPAIR SET RATCHET 7120202	1
7120203P	REPAIR SET RATCHET 7120203	1

RATCHET HANDLE - 60 TEETH

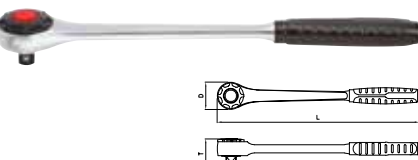

ART. NO.	SIZE	L(MM)	T(MM)	D(MM)	G	PCS/BAG
7120704	3/4"	505	64	68	1934	1

REPAIR SET



ART. NO.	DESCRIPTION	PCS/BAG
7120704P	REPAIR SET RATCHET 7120704	1

RATCHET HANDLE - 24 TEETH

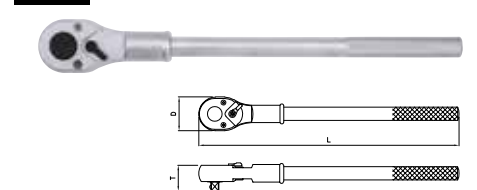

ART. NO.	SIZE	L(MM)	T(MM)	D(MM)	G	PCS/BAG
7121204	3/4"	500	55	64	2608	2
7121305	1"	660	67	72	4390	1

RATCHET HANDLE

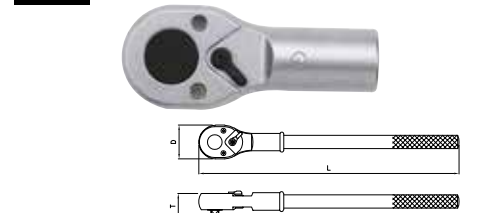

ART. NO.	SIZE	L(MM)	T(MM)	D(MM)	G	PCS/BAG
7121205	1"	500	64	55	2618	2

REPAIR SET



ART. NO.	DESCRIPTION	PCS/BAG
7121204P	REPAIR SET RATCHET 7121204	1
7121205P	REPAIR SET RATCHET 7121205	1

SWIVEL HANDLE

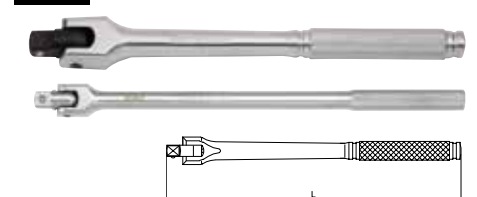

ART. NO.	SIZE	L(MM)	G	PCS/BAG
7232200	3/8"	200	280	10
7232250	3/8"	250	342	5
7233250	1/2"	250	490	5
7233380	1/2"	380	782	2
7234500	3/4"	500	1804	1
7234600	3/4"	630	2178	1

SWIVEL GRIP HANDLE

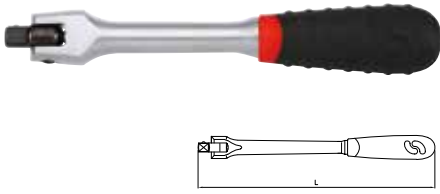

ART. NO.	SIZE	L(MM)	G	PCS/BAG
7271150	1/4"	155	98	10
7272200	3/8"	220	262	10
7272250	3/8"	250	294	5
7273250	1/2"	270	490	5
7273380	1/2"	370	650	2

REPAIR SET



ART. NO.	DESCRIPTION	PCS/BAG
7271P	REPAIR SET SWIVEL HANDLE 7271150	1
7232P	7232200, 7232250, 7272200 & 7272250	1
7233P	7233250, 7233380, 7273250 & 7273380	1

SWIVEL HANDLE 24"

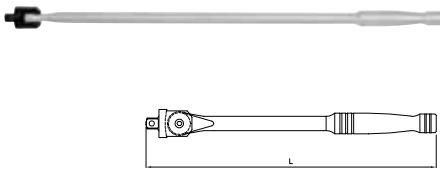

ART. NO.	SIZE	L(MM)	G	PCS/BAG
7233600	1/2"	635	1386	1

REPAIR SET



ART. NO.	DESCRIPTION	PCS/BAG
7233601	REPAIR SET SWIVEL HANDLE OF 7233600	1

SPINNER - 150 MML

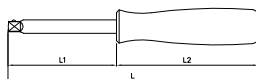

ART. NO.	SIZE	L1(MM)	L2(MM)	L(MM)	G	PCS/BAG
72401	1/4"	65	85	150	85	10

SLIDING T-HANDLE UNIVERSAL JOINT

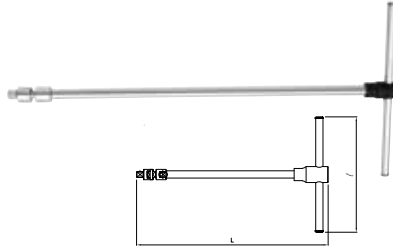

ART. NO.	SIZE	L(MM)	l(MM)	G	PCS/BAG
7152450	3/8"	450	200	452	10

SPEEDY T-GRIP

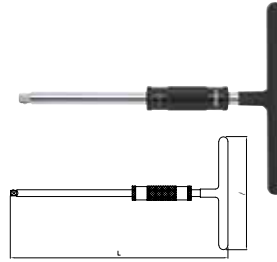

ART. NO.	SIZE	L(MM)	l(MM)	G	PCS/BAG
72601	1/4"	322	140	320	5
72602	3/8"	326	181	550	5
72603	1/2"	330	242	1088	5

SLIDING T-HANDLE

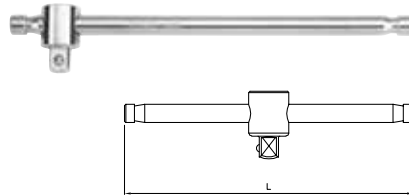

ART. NO.	SIZE	L(MM)	G	PCS/BAG
7131115	1/4"	115	45	10
7132165	3/8"	165	150	10
7133250	1/2"	250	345	5
7134450	3/4"	450	1370	2
7135560	1"	560	3292	2

SLIDING T-HANDLE



ART. NO.	SIZE	L(MM)	G	PCS/BAG
7135550	1"	560	2656	2

EXTENSION

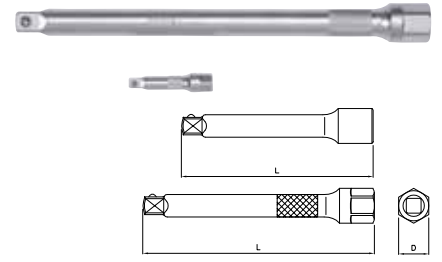

ART. NO.	SIZE	L(MM)	D(MM)	G	PCS/BAG
7141050	1/4"	50	11	22	10
7141100	1/4"	100	11	42	10
7141150	1/4"	150	11	64	10
7141250	1/4"	250	12	106	10
7142044	3/8"	44	16	36	10
7142075	3/8"	75	16	70	10
7142150	3/8"	150	16	140	10
7142200	3/8"	200	16	200	10
7142250	3/8"	250	16	230	10
7142300	3/8"	300	16	295	10
7142450	3/8"	450	16	400	10
7142600	3/8"	600	16	550	10
7143125	1/2"	125	22	216	10
7143250	1/2"	250	22	416	5
7144100	3/4"	100	35.8	402	2
7144200	3/4"	200	35.8	738	2
7145200	1"	200	48.0	1302	2
7145400	1"	410	48.0	2264	2

WOBBLE EXTENSION

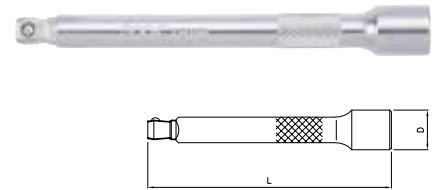

ART. NO.	SIZE	L(MM)	D(MM)	G	PCS/BAG
7261050	1/4"	50	12,3	24	10
7261100	1/4"	100	12,3	44	10
7261250	1/4"	250	12,3	106	10
7262044	3/8"	44	16,0	40	10
7262075	3/8"	75	16,0	65	10
7262150	3/8"	150	16,0	140	10
7262200	3/8"	200	16,0	192	10
7262250	3/8"	250	16,0	140	10
7262300	3/8"	300	16,0	295	10
7262450	3/8"	450	16,0	400	10
7263050	1/2"	50	24,0	95	10
7263125	1/2"	125	24,0	200	10
7263250	1/2"	250	24,0	430	5
7263500	1/2"	500	24,0	840	1

LOCK-IN EXTENSION

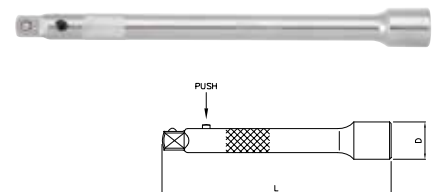

ART. NO.	SIZE	L(MM)	D(MM)	G	PCS/BAG
7183075	1/2"	75	23.8	128	10
7183125	1/2"	125	23.8	206	10
7183250	1/2"	250	23.8	410	10

LOCK-IN EXTENSION



ART. NO.	SIZE	L(MM)	D(MM)	G	PCS/BAG
7184400	3/4"	400	36	1556	1

FLEXIBLE EXTENSION 6"



ART. NO.	SIZE	L(MM)	G	PCS/BAG
7211	1/4"	145	55	10

IMPACT EXTENSION



ART. NO.	SIZE	L(MM)	D(MM)	G	PCS/BAG
7342075	3/8"	75	19	80	10
7343075	1/2"	75	25	146	10
7343125	1/2"	125	25	226	5
7343250	1/2"	250	25	432	5

IMPACT EXTENSION

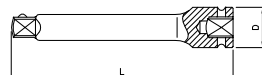

ART. NO.	SIZE	L(MM)	D(MM)	G	PCS/BAG
7344150	3/4"	150	40.0	700	1
7344250	3/4"	250	40.0	1060	1
7344400	3/4"	400	40.0	1600	1

IMPACT EXTENSION

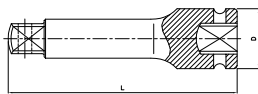

ART. NO.	SIZE	L(MM)	D(MM)	G	PCS/BAG
7345150	1"	150	52	1170	1
7345175	1"	175	52	1390	1
7345250	1"	250	52	1880	1
7345400	1"	400	52	2870	1

UNIVERSAL JOINT

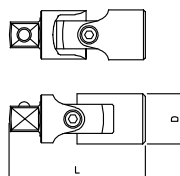

ART. NO.	SIZE	L(MM)	D(MM)	G	PCS/BAG
71511	1/4"	37	13.8	24	10
71521	3/8"	52	18.7	60	10
71531	1/2"	70	24.6	138	10

REPAIR SET



ART. NO.	DESCRIPTION	PCS/BAG
71511P	REPAIR SET UNIVERSAL JOINT 71511	1
71521P	REPAIR SET UNIVERSAL JOINT 71521	1
71531P	REPAIR SET UNIVERSAL JOINT 71531	1

IMPACT UNIVERSAL JOINT

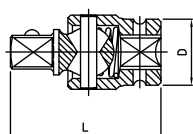

ART. NO.	SIZE	L(MM)	D(MM)	G	PCS/BAG
73521	3/8"	46	24	78	10
73531	1/2"	60	28	142	10
73541	3/4"	94	42	500	1

ADAPTOR

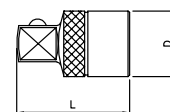

ART. NO.	SIZE	L(MM)	D(MM)	G	PCS/BAG
71912	1/4"(F)X3/8"(M)	26	12	18	10
71921	3/8"(F)X1/4"(M)	27	17	20	10
71923	3/8"(F)X1/2"(M)	36	18	45	10
71932	1/2"(F)X3/8"(M)	36	22	48	10
71934	1/2"(F)X3/4"(M)	46	26	124	10
71943	3/4"(F)X1/2"(M)	51	31,5	134	10

IMPACT ADAPTOR

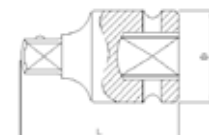

ART. NO.	SIZE	L(MM)	D(MM)	G	PCS/BAG
73612	1/4"(F)X3/8"(M)	26	14	20	10
73621	3/8"(F)X1/4"(M)	32	22	46	10
73623	3/8"(F)X1/2"(M)	36	22	68	10
73632	1/2"(F)X3/8"(M)	38	25	68	10
73634	1/2"(F)X3/4"(M)	48	30	160	10
73643	3/4"(F)X1/2"(M)	56	44	320	10

IMPACT ADAPTOR

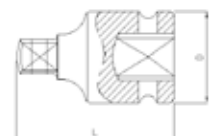

ART. NO.	SIZE	L(MM)	D(MM)	G	PCS/BAG
73645	3/4"(F)X1"(M)	63	44	440	1

ADAPTOR

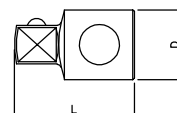

ART. NO.	SIZE	L(MM)	D(MM)	G	PCS/BAG
71623	3/8"(F)X1/2"(M)	43	23,8	68	10
71632	1/2"(F)X3/8"(M)	39	23,8	66	10
7135	1"	80	49	632	2

BIT HOLDER

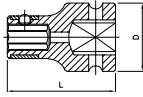

ART. NO.	SIZE	L(MM)	D(MM)	G	PCS/BAG
72011	1/4"(F) X 1/4"(F)	25	12	12	10
72023	3/8"(F) X 10MM(F)	29	17	28	10
72032	1/2"(F) X 5/16(F)	38	22	44	10
72033	1/2"(F) X 10MM(F)	38	22	52	10

IMPACT BIT HOLDER

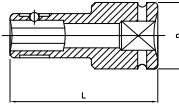

ART. NO.	SIZE	L(MM)	D(MM)	G	PCS/BAG
73721	3/8"(F)X1/4"(F)	40	19	36	10

MAGNET SOCKET PICK-UP 1/4"

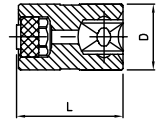

ART. NO.	SIZE	L(MM)	D(MM)	G	PCS/BAG
72225	1/4"	25	12	16	10

INSERT HOLDER FOR BITS 9X12



ART. NO.	SIZE	L(MM)	G	PCS/BAG
7201001	1/4"	42.5	52	10
7202001	5/6"	42.5	52	10

Torque wrenches



LIGHT WEIGHT



SONIC HAS TWO SERIES OF ADJUSTABLE CLICK-TYPE TORQUE WRENCHES IN HER PROGRAM. SONIC OFFERS YOU A RANGE FROM 1/4" TO 1" DRIVE WITH NM RANGING FROM 4NM TO 1000NM.



CLEARLY VISIBLE SCALE IN NM AND FT.LB



DIRECT FIT, LEFT OR RIGHT RATCHET ACTION WITH SONIC QUICK RELEASE SYSTEM



SONIC PUSH LOCK SYSTEM: RAPID, ACCURATE, SAFE SETTING ACTION.



COMFORTABLE ERGONOMIC HANDLE

WORK EFFICIENT
WORK WITH SONIC

TORQUE WRENCH

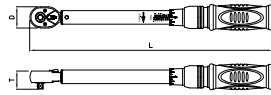

ART. NO.	SIZE	NM	D(MM)	T(MM)	L(MM)	G
73110420	1/4"	4-20	28.0	23.5	325	632
73121060	3/8"	10-60	28.0	27.3	325	670
731220100	3/8"	20-100	36.5	30.3	435	1314
731340200	1/2"	40-200	43.5	41.2	510	1604
731360340	1/2"	60-340	43.5	41.2	613	1792
7314600	3/4"	100-600	63.5	52.2	1050	5500
7314800	3/4"	150-800	63.5	52.2	1234	5600
73141000	3/4"	200-1000	70.0	60.1	1234	6150
7315800	1"	150-800	63.5	57.2	1234	5600
73151000	1"	200-1000	70.0	65.5	1234	6150

TORQUE WRENCH

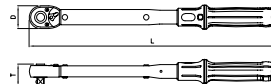

ART. NO.	SIZE	NM	D(MM)	T(MM)	L(MM)	G
73210525	1/4"	5-25	26	22	290	405
73220550	3/8"	5-50	40.5	37	360	920
732210100	3/8"	10-100	40.5	37	405	1020
732310100	1/2"	10-100	40.5	40	405	1020
732320200	1/2"	20-200	40.5	40	500	1220
732360300	1/2"	60-300	40.5	40	595	1330
732380400	1/2"	80-400	40.5	40	680	1820
73241000	3/4"	200-1000	63.0	63	1250	7200
7324550	3/4"	110-550	63.0	58	970	3700
7324750	3/4"	150-750	63.0	58	1150	5600
73251000	1"	200-1000	63.0	63	1250	7200
7325750	1"	150-750	63.0	58	1150	5600

600907



6.3
1/4"



TORQUE WRENCH SET EXCHANGEABLE HEAD 9X12 RING+OPEN 4-20N 8-PCS

THIS TOOL ALLOWS THE USUAL 1/4" TORQUE OPERATION BUT WITH THE ADDED INNOVATION OF CHANGING THE RATCHET HEAD TO A SPANNER HEAD FOR TIGHTENING BOLTS TO A SPECIFIC TORQUE.

- 9X12 TORQUE WRENCH 4-20NM
- 9X12 OPEN ENDED INSERT TOOL 13, 17, 19 MM
- 9X12 RING INSERT TOOL 13, 17, 19 MM
- 9X12 72 TEETH RATCHET INSERT TOOL 1/4"

600908



10
3/8"



TORQUE WRENCH SET EXCHANGEABLE HEAD 9X12 RING+OPEN 10-60N 8-PCS

THIS TOOL ALLOWS THE USUAL 3/8" TORQUE OPERATION BUT WITH THE ADDED INNOVATION OF CHANGING THE RATCHET HEAD TO A SPANNER HEAD FOR TIGHTENING BOLTS TO A SPECIFIC TORQUE.

- 9X12 TORQUE WRENCH 10-60NM
- 9X12 OPEN ENDED INSERT TOOL 13, 17, 19MM
- 9X12 RING INSERT TOOL 13, 17, 19MM
- 9X12 72 TEETH RATCHET INSERT TOOL 3/8"

REPAIR SET



ART. NO.	DESCRIPTION	PCS/BAG
73110420P	REPAIR SET TORQUE WRENCH 73110420	1
73121060P	REPAIR SET TORQUE WRENCH 73121060	1
731220100P	REPAIR SET TORQUE WRENCH 731220100	1
7313P	REPAIR SET TORQUE WRENCH 731340200 & 731360340	1
7314P	REPAIR SET TORQUE WRENCH 7314600 & 7314800	1
73141000P	REPAIR SET TORQUE WRENCH 73141000	1
7315800P	REPAIR SET TORQUE WRENCH 7315800	1
73151000P	REPAIR SET TORQUE WRENCH 73151000	1

REPAIR SET



ART. NO.	DESCRIPTION	PCS/BAG
73210525P	REPAIR SET TORQUE WRENCH 73210525	1
7322P	REPAIR SET TORQUE WRENCH 73220550 & 732210100	1
7323P	REPAIR SET TORQUE WRENCH 732310100, 732320200, 732360300 & 732380400	1
7324550P	REPAIR SET 7324550	1
7324750P	REPAIR SET 7324750 & 73241000	1
7325P	REPAIRSET 7325750 & 73251000	1

601105



12.5
1/2"



TORQUE WRENCH EXCHANGEABLE HEAD 14X18 RING HEAD 60-340N, 11-PCS

THIS TOOL ALLOWS THE USUAL 1/2" TORQUE OPERATION BUT WITH THE ADDED INNOVATION OF CHANGING THE RATCHET HEAD TO A SPANNER HEAD FOR TIGHTENING BOLTS TO A SPECIFIC TORQUE.

- 14X18 TORQUE WRENCH 60-340NM
- 14X18 RING INSERT TOOL 13, 14, 15, 17, 19, 22, 24, 27, 30MM
- 14X18 72 TEETH RATCHET INSERT TOOL 1/2"

601106



12.5
1/2"



TORQUE WRENCH EXCHANGEABLE HEAD 14X18 OPEN HEAD 60-340N, 11-PCS

THIS TOOL ALLOWS THE USUAL 1/2" TORQUE OPERATION BUT WITH THE ADDED INNOVATION OF CHANGING THE RATCHET HEAD TO A SPANNER HEAD FOR TIGHTENING BOLTS TO A SPECIFIC TORQUE.

- 14X18 TORQUE WRENCH 60-340NM
- 14X18 RING INSERT TOOL 13, 14, 15, 17, 19, 22, 24, 27, 30MM
- 14X18 72 TEETH RATCHET INSERT TOOL 1/2"

Bit sockets

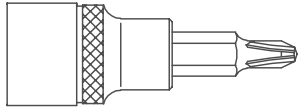

EUROPEAN HANGER +
EAN-CODE + ART. NO.



THE BIT SOCKETS ARE EXTREMELY
STURDY, SLIM AND COMPACT.
MADE OF HIGH QUALITY CHROME
VANADIUM STEEL



SONIC HAS A WIDE RANGE OF DIFFERENT SIZES AND DIMENSIONS



NON SLIP



DIRECT FIT



SONIC OFFERS A WIDE SELECTION
OF DIFFERENT BIT SOCKETS ON RAIL



LOW TOLERANCE

SONIC OFFERS A COMPLETE RANGE OF DIFFERENT BIT SOCKETS. THE BIT SOCKETS ARE MADE OF OUTSTANDING CHROME VANADIUM QUALITY AND MEET OR EXCEED DIN STANDARDS. THESE SONIC BIT SOCKETS HAVE ALSO A SUPERB FINISHMENT AND SHAPE.



PH
⊕



PZ
⊕



SLOTTED
⊖



HEX
⊙



HEX BALL
⊙



HEX SAE
⊙



TX
⊙



TX BALL
⊙



TX TAMPERPROOF
⊙



TX PLUS (5 LOBES)
⊙



SPLINE
⊙



SPLINE TAMPERPROOF
⊙



RIBE
⊙

BIT SOCKET PH 1/4"

DIN NO. 3120

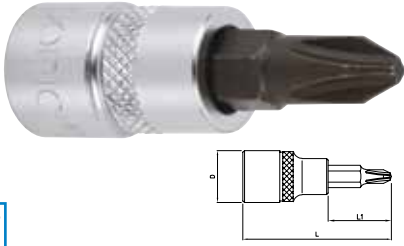

6.3
1/4"

ART. NO.	SIZE	L(MM)	L1(MM)	D(MM)	G	PCS/BAG
8113700	PH.0	37	16	12	14	10
8113701	PH.1	37	16	12	14	10
8113702	PH.2	37	16	12	14	10
8113703	PH.3	37	16	12	16	10

BIT SOCKET PZ 1/4"

DIN NO. 3120

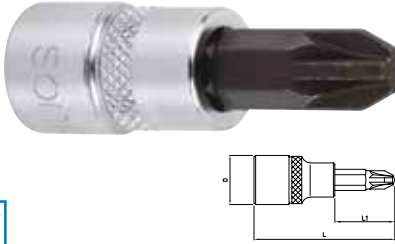

6.3
1/4"

ART. NO.	SIZE	L(MM)	L1(MM)	D(MM)	G	PCS/BAG
8123700	PZ.0	37	16	12	14	10
8123701	PZ.1	37	16	12	14	10
8123702	PZ.2	37	16	12	14	10
8123703	PZ.3	37	16	12	16	10

BIT SOCKET SLOTTED 1/4"

DIN NO. 3120

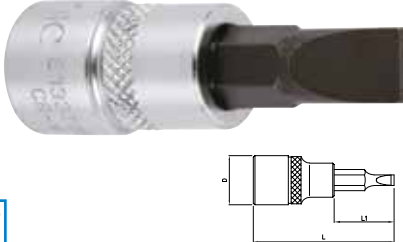

6.3
1/4"

ART. NO.	SIZE	L(MM)	L1(MM)	D(MM)	G	PCS/BAG
8133704	4	37	16	12	14	10
8133705	5.5	37	16	12	14	10
8133706	6.5	37	16	12	16	10

BIT SOCKET HEX 1/4"

DIN NO. 3120

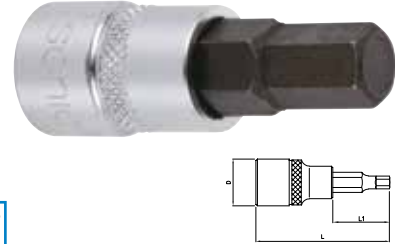

6.3
1/4"

ART. NO.	SIZE	L(MM)	L1(MM)	D(MM)	G	PCS/BAG
8143703	3	37	16	12	14	10
8143704	4	37	16	12	16	10
8143705	5	37	16	12	16	10
8143705	5.5	37	16	12	16	10
8143706	6	37	16	12	16	10
8143707	7	37	16	13	20	10
8143708	8	37	16	13	22	10
8143709	9	37	16	13	24	10
8143710	10	37	16	13	26	10

BIT SOCKET HEX BALL 1/4"

DIN NO. 3120

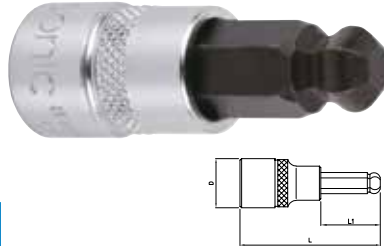

6.3
1/4"

ART. NO.	SIZE	L(MM)	L1(MM)	D(MM)	G	PCS/BAG
8103703	3	37	16	12	14	10
8103704	4	37	16	12	16	10
8103705	5	37	16	12	16	10
8103705	5.5	37	16	12	16	10
8103706	6	37	16	12	16	10
8103707	7	37	16	13	20	10
8103708	8	37	16	13	22	10
8103709	9	37	16	13	24	10
8103710	10	37	16	13	26	10

BIT SOCKET HEX 1/4" (SAE)

DIN NO. 3120

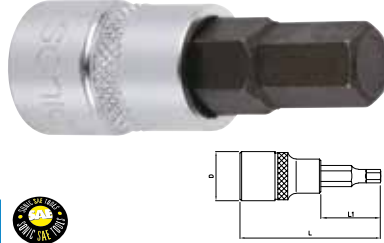

6.3
1/4"

ART. NO.	SIZE	L(MM)	L1(MM)	D(MM)	G	PCS/BAG
81413703	1/8"	37	16	12	15	10
81413704	5/32"	37	16	12	15	10
81413705	3/16"	37	16	12	15	10
81413706	7/32"	37	16	12	15	10
81413707	1/4"	37	16	12	15	10
81413708	5/16"	37	16	13	20	10
81413710	3/8"	37	16	13	25	10

BIT SOCKET TX 1/4"

DIN NO. 3120

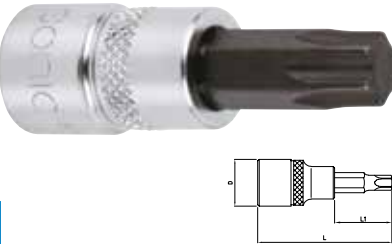

6.3
1/4"

ART. NO.	SIZE	L(MM)	L1(MM)	D(MM)	G	PCS/BAG
8163706	T6	37	16	12	14	10
8163707	T7	37	16	12	14	10
8163708	T8	37	16	12	14	10
8163709	T9	37	16	12	14	10
8163710	T10	37	16	12	14	10
8163715	T15	37	16	12	16	10
8163720	T20	37	16	12	16	10
8163725	T25	37	16	12	16	10
8163727	T27	37	16	12	16	10
8163730	T30	37	16	12	16	10
8163740	T40	37	16	12	16	10

BIT SOCKET TX BALL 1/4"

DIN NO. 3120

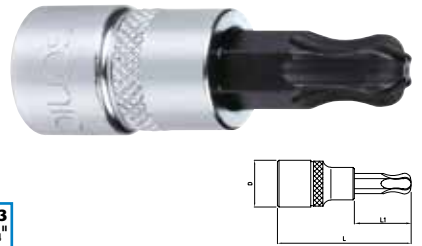

6.3
1/4"

ART. NO.	SIZE	L(MM)	L1(MM)	D(MM)	G	PCS/BAG
81613710	T10	37	16	12	14	10
81613715	T15	37	16	12	14	10
81613720	T20	37	16	12	14	10
81613725	T25	37	16	12	14	10
81613727	T27	37	16	12	14	10
81613730	T30	37	16	12	14	10
81613740	T40	37	16	12	14	10

BIT SOCKET TX TAMPERPROOF 1/4"

DIN NO. 3120

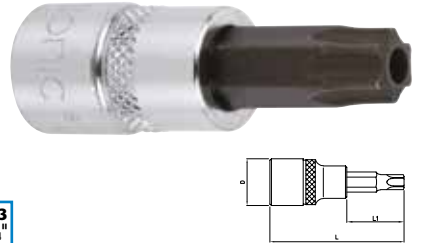

6.3
1/4"

ART. NO.	SIZE	L(MM)	L1(MM)	D(MM)	G	PCS/BAG
8173706	T6H	37	16	12	14	10
8173707	T7H	37	16	12	14	10
8173708	T8H	37	16	12	14	10
8173709	T9H	37	16	12	14	10
8173710	T10H	37	16	12	14	10
8173715	T15H	37	16	12	14	10
8173720	T20H	37	16	12	14	10
8173725	T25H	37	16	12	14	10
8173727	T27H	37	16	12	16	10
8173730	T30H	37	16	12	16	10
8173740	T40H	37	16	12	16	10

TAMPER-RESISTANT 1/4", TX PLUS (5 LOBES)

DIN NO. 3120

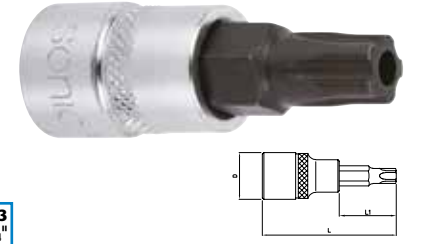

6.3
1/4"

ART. NO.	SIZE	L(MM)	L1(MM)	D(MM)	G	PCS/BAG
8153708	8IPR	37	16	12	14	10
8153710	10IPR	37	16	12	14	10
8153715	15IPR	37	16	12	14	10
8153720	20IPR	37	16	12	14	10
8153725	25IPR	37	16	12	14	10
8153727	27IPR	37	16	12	16	10
8153730	30IPR	37	16	12	16	10
8153740	40IPR	37	16	12	16	10
8153745	45IPR	37	16	13	20	10
8153750	50IPR	37	16	13	22	10

BIT SOCKET SPLINE 1/4"

DIN NO. 3120

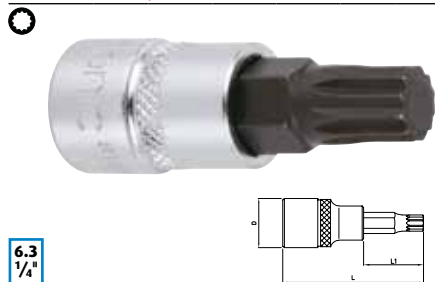

6.3
1/4"

ART. NO.	SIZE	L(MM)	L1(MM)	D(MM)	G	PCS/BAG
8183704	M4	37	16	12	14	10
8183705	M5	37	16	12	16	10
8183706	M6	37	16	12	16	10
8183708	M8	37	16	13	20	10
8183710	M10	37	16	13	24	10

BIT SOCKET SLOTTED 3/8"

DIN NO. 3120

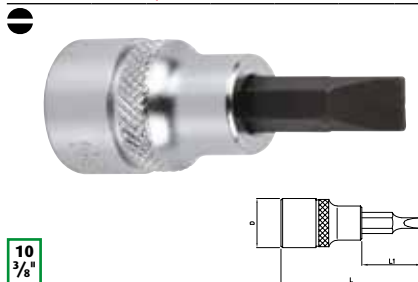

10
3/8"

ART. NO.	SIZE	L(MM)	L1(MM)	D(MM)	G	PCS/BAG
82348055	5.5	48	20	18	32	10
8234806	6	48	20	18	32	10
8234807	7	48	20	18	36	10
8234808	8	48	20	18	38	10

BIT SOCKET HEX BALL 3/8", 90MML

DIN NO. 3120

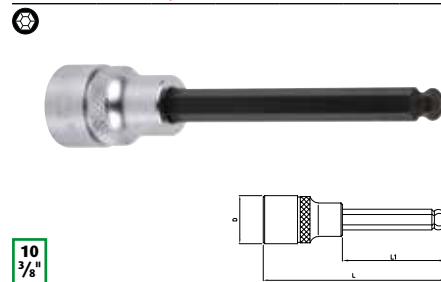

10
3/8"

ART. NO.	SIZE	L(MM)	L1(MM)	D(MM)	G	PCS/BAG
8209003	3	90	62	18	44	10
8209004	4	90	62	18	44	10
8209005	5	90	62	18	44	10
82090055	5.5	90	62	18	46	10
8209006	6	90	62	18	46	10
8209007	7	90	62	18	50	10
8209008	8	90	62	18	58	10
8209009	9	90	62	18	76	10
8209010	10	90	62	18	78	10

BIT SOCKET RIBE 1/4"

DIN NO. 3120

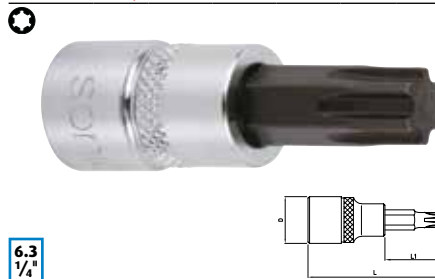

6.3
1/4"

ART. NO.	SIZE	L(MM)	L1(MM)	D(MM)	G	PCS/BAG
8193704	M4	37	16	12	14	10
8193705	M5	37	16	12	16	10
8193706	M6	37	16	12	16	10
8193707	M7	37	16	12	16	10
8193708	M8	37	16	13	20	10
8193710	M10	37	16	13	24	10

BIT SOCKET HEX 3/8"

DIN NO. 3120



10
3/8"

ART. NO.	SIZE	L(MM)	L1(MM)	D(MM)	G	PCS/BAG
8244803	3	48	20	18	32	10
8244804	4	48	20	18	32	10
8244805	5	48	20	18	32	10
82448055	5.5	48	20	18	34	10
8244806	6	48	20	18	34	10
8244807	7	48	20	18	36	10
8244808	8	48	20	18	38	10
8244809	9	48	20	18	48	10
8244810	10	48	20	18	50	10
8244812	12	48	20	18	52	10

BIT SOCKET HEX 3/8" (SAE)

DIN NO. 3120

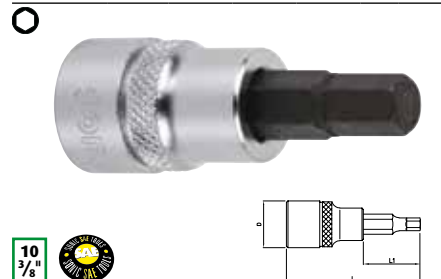

10
3/8"

ART. NO.	SIZE	L(MM)	L1(MM)	D(MM)	G	PCS/BAG
82414803	1/8"	48	20	18	35	10
82414804	5/32"	48	20	18	35	10
82414805	3/16"	48	20	18	35	10
824148055	7/32"	48	20	18	35	10
82414806	1/4"	48	20	18	35	10
82414808	5/16"	48	20	18	40	10
82414810	3/8"	48	20	18	50	10
82414812	7/16"	48	20	18	55	10
82414813	1/2"	48	20	18	60	10

BIT SOCKET PH 3/8"

DIN NO. 3120

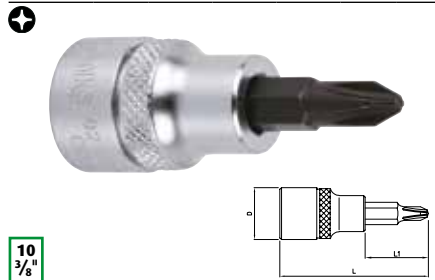

10
3/8"

ART. NO.	SIZE	L(MM)	L1(MM)	D(MM)	G	PCS/BAG
8214801	PH.1	48	20	18	34	10
8214802	PH.2	48	20	18	34	10
8214803	PH.3	48	20	18	34	10

BIT SOCKET HEX 3/8", 90MML

DIN NO. 3120

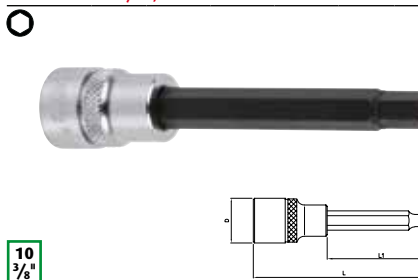

10
3/8"

ART. NO.	SIZE	L(MM)	L1(MM)	D(MM)	G	PCS/BAG
8249003	3	90	62	18	44	10
8249004	4	90	62	18	44	10
8249005	5	90	62	18	44	10
82490055	5.5	90	62	18	46	10
8249006	6	90	62	18	46	10
8249007	7	90	62	18	50	10
8249008	8	90	62	18	58	10
8249009	9	90	62	18	76	10
8249010	10	90	62	18	78	10

BIT SOCKET TX 3/8"

DIN NO. 3120

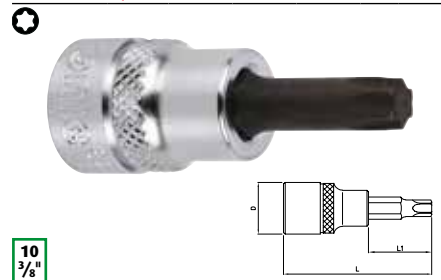

10
3/8"

ART. NO.	SIZE	L(MM)	L1(MM)	D(MM)	G	PCS/BAG
8264808	T8	48	20	18	32	10
8264810	T10	48	20	18	32	10
8264815	T15	48	20	18	32	10
8264820	T20	48	20	18	32	10
8264825	T25	48	20	18	32	10
8264827	T27	48	20	18	32	10
8264830	T30	48	20	18	32	10
8264840	T40	48	20	18	34	10
8264845	T45	48	20	18	36	10
8264850	T50	48	20	18	38	10
8264855	T55	48	20	18	50	10
8264860	T60	48	20	18	54	10

BIT SOCKET PZ 3/8"

DIN NO. 3120

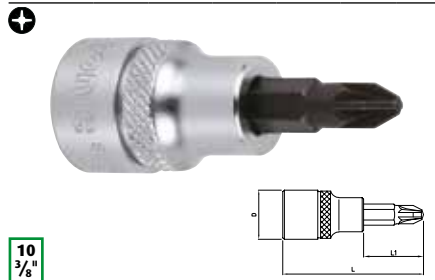

10
3/8"

ART. NO.	SIZE	L(MM)	L1(MM)	D(MM)	G	PCS/BAG
8224801	PZ.1	48	20	18	34	10
8224802	PZ.2	48	20	18	34	10
8224803	PZ.3	48	20	18	34	10

BIT SOCKET TX 3/8", 90MML

DIN NO. 3120

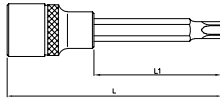

10
3/8"

ART. NO.	SIZE	L(MM)	L1(MM)	D(MM)	G	PCS/BAG
8269008	T8	90	62	18	44	10
8269010	T10	90	62	18	44	10
8269015	T15	90	62	18	44	10
8269020	T20	90	62	18	44	10
8269025	T25	90	62	18	44	10
8269027	T27	90	62	18	44	10
8269030	T30	90	62	18	44	10
8269040	T40	90	62	18	44	10
8269045	T45	90	62	18	52	10
8269050	T50	90	62	18	58	10

BIT SOCKET SPLINE 3/8"

DIN NO. 3120

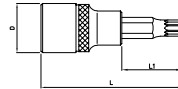

10
3/8"

ART. NO.	SIZE	L(MM)	L1(MM)	D(MM)	G	PCS/BAG
8284804	M4	48	20	18	30	10
8284805	M5	48	20	18	32	10
8284806	M6	48	20	18	34	10
8284808	M8	48	20	18	36	10
8284809	M9	48	20	18	48	10
8284810	M10	48	20	18	50	10
8284812	M12	48	20	18	54	10

BIT SOCKET RIBE 3/8", 90MML

DIN NO. 3120

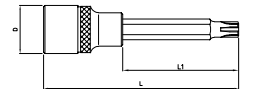

10
3/8"

ART. NO.	SIZE	L(MM)	L1(MM)	D(MM)	G	PCS/BAG
8299005	M5	90	62	18	45	10
8299006	M6	90	62	18	45	10
8299007	M7	90	62	18	55	10
8299008	M8	90	62	18	57	10
8299009	M9	90	62	18	77	10
8299010	M10	90	62	18	79	10
8299012	M12	90	62	18	83	10

BIT SOCKET TX TAMPERPROOF 3/8"

DIN NO. 3120

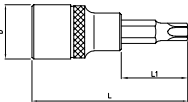

10
3/8"

ART. NO.	SIZE	L(MM)	L1(MM)	D(MM)	G	PCS/BAG
8274808	T8H	48	20	18	32	10
8274810	T10H	48	20	18	32	10
8274815	T15H	48	20	18	32	10
8274820	T20H	48	20	18	32	10
8274825	T25H	48	20	18	32	10
8274827	T27H	48	20	18	32	10
8274830	T30H	48	20	18	32	10
8274840	T40H	48	20	18	34	10
8274845	T45H	48	20	18	36	10
8274850	T50H	48	20	18	36	10
8274855	T55H	48	20	18	50	10
8274860	T60H	48	20	18	52	10

BIT SOCKET SPLINE 3/8", 90MML

DIN NO. 3120

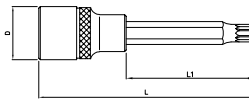

10
3/8"

ART. NO.	SIZE	L(MM)	L1(MM)	D(MM)	G	PCS/BAG
8289005	M5	90	62	18	44	10
8289006	M6	90	62	18	46	10
8289008	M8	90	62	18	56	10
8289009	M9	90	62	18	76	10
8289010	M10	90	62	18	78	10
8289012	M12	90	62	18	92	10

BIT SOCKET HEX 1/2"

DIN NO. 3120

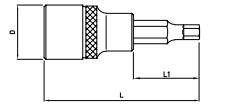

12.5
1/2"

ART. NO.	SIZE	L(MM)	L1(MM)	D(MM)	G	PCS/BAG
83406204	4	62	24	22	70	10
83406205	5	62	24	22	70	10
83406255	5.5	62	24	22	70	10
83406206	6	62	24	22	70	10
83406207	7	62	24	22	70	10
83406208	8	62	24	22	70	10
83406209	9	62	24	22	80	10
83406210	10	62	24	22	80	10
83406212	12	62	24	24	110	10
83406214	14	62	24	24	125	10
83406217	17	62	24	24	140	10
83406219	19	62	24	24	150	10
83406222	22	62	24	25	180	10
83406224	24	62	24	27	200	10

BIT SOCKET TX TAMPERPROOF 3/8", 90MML

DIN NO. 3120

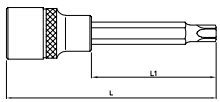

10
3/8"

ART. NO.	SIZE	L(MM)	L1(MM)	D(MM)	G	PCS/BAG
8279008	T8H	90	62	18	44	10
8279010	T10H	90	62	18	44	10
8279015	T15H	90	62	18	44	10
8279020	T20H	90	62	18	44	10
8279025	T25H	90	62	18	44	10
8279027	T27H	90	62	18	44	10
8279030	T30H	90	62	18	44	10
8279040	T40H	90	62	18	48	10
8279045	T45H	90	62	18	52	10
8279050	T50H	90	62	18	58	10

BIT SOCKET RIBE 3/8"

DIN NO. 3120

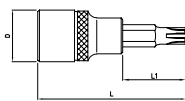

10
3/8"

ART. NO.	SIZE	L(MM)	L1(MM)	D(MM)	G	PCS/BAG
8294804	M4	48	20	18	30	10
8294805	M5	48	20	18	32	10
8294806	M6	48	20	18	34	10
8294807	M7	48	20	18	36	10
8294808	M8	48	20	18	36	10
8294809	M9	48	20	18	48	10
8294810	M10	48	20	18	50	10
8294812	M12	48	20	18	54	10

BIT SOCKET HEX 1/2", 100MML

DIN NO. 3120

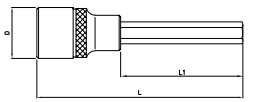

12.5
1/2"

ART. NO.	SIZE	L(MM)	L1(MM)	D(MM)	G	PCS/BAG
83410005	5	100	62	22	84	10
83410006	6	100	62	22	84	10
83410007	7	100	62	22	86	10
83410008	8	100	62	22	86	10
83410009	9	100	62	22	104	10
83410010	10	100	62	22	106	10
83410012	12	100	62	24	142	10
83410014	14	100	62	24	172	10
83410017	17	100	62	24	212	10

BIT SOCKET HEX 1/2", 140MML

DIN NO. 3120

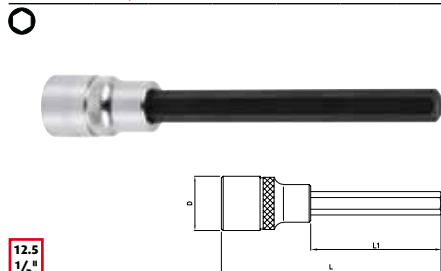

12.5
1/2"

ART. NO.	SIZE	L(MM)	L1(MM)	D(MM)	G	PCS/BAG
83414007	7	140	102	24	121	10
83414010	10	140	102	22	132	10
83414011	11	140	102	24	183	10
83414013	13	140	102	24	202	10
83414014	14	140	102	24	220	10

BIT SOCKET HEX 1/2", 248MML

DIN NO. 3120

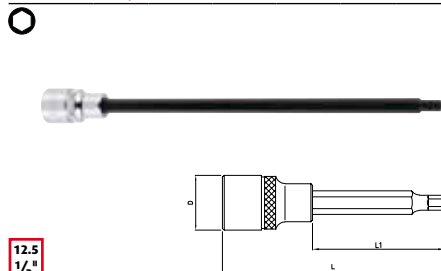

12.5
1/2"

ART. NO.	SIZE	L(MM)	L1(MM)	D(MM)	G	PCS/BAG
83424806	6	248	210	22	150	10

BIT SOCKET HEX BALL 1/2"

DIN NO. 3120

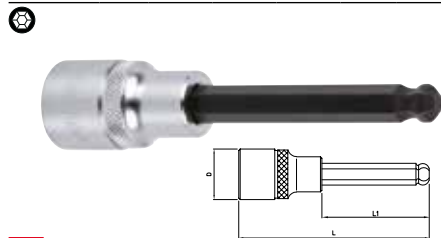

12.5
1/2"

ART. NO.	SIZE	L(MM)	L1(MM)	D(MM)	G	PCS/BAG
83010005	5	100	62	22	84	10
830100055	5.5	100	62	22	84	10
83010006	6	100	62	22	84	10
83010007	7	100	62	22	86	10
83010008	8	100	62	22	86	10
83010009	9	100	62	22	104	10
83010010	10	100	62	22	106	10
83010012	12	100	62	24	142	10

BIT SOCKET HEX BALL 1/2", 140MML

DIN NO. 3120

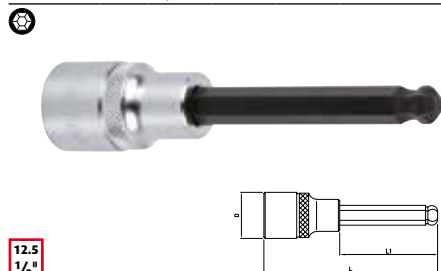

12.5
1/2"

ART. NO.	SIZE	L(MM)	L1(MM)	D(MM)	G	PCS/BAG
83014005	5	140	102	24	119	10
83014006	6	140	102	24	120	10
83014007	7	140	102	24	121	10
83014008	8	140	102	24	122	10
83014010	10	140	102	24	150	10
83014012	12	140	102	24	183	10

BIT SOCKET HEX 1/2" (SAE)

DIN NO. 3120

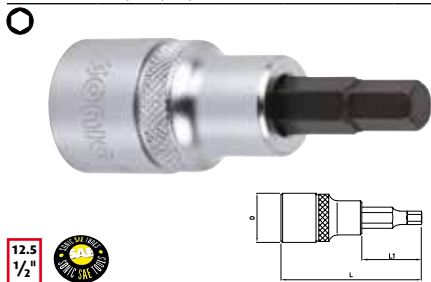

12.5
1/2"

ART. NO.	SIZE	L(MM)	L1(MM)	D(MM)	G	PCS/BAG
834106205	3/16"	62	24	22	65	10
834106206	1/4"	62	24	22	65	10
834106207	9/32"	62	24	22	70	10
834106208	5/16"	62	24	22	70	10
834106209	11/32"	62	24	22	80	10
834106210	3/8"	62	24	22	80	10
834106212	7/16"	62	24	22	85	10
834106213	1/2"	62	24	24	110	10
834106214	9/16"	62	24	24	125	10
834106217	5/8"	62	24	24	135	10

BIT SOCKET TX 1/2"

DIN NO. 3120

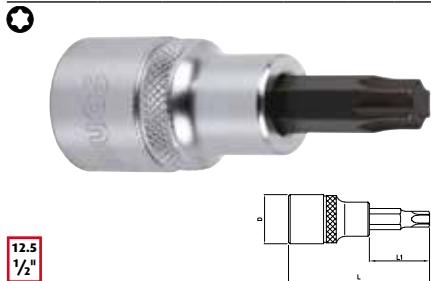

12.5
1/2"

ART. NO.	SIZE	L(MM)	L1(MM)	D(MM)	G	PCS/BAG
83606220	T20	62	24	22	65	10
83606225	T25	62	24	22	65	10
83606227	T27	62	24	22	65	10
83606230	T30	62	24	22	65	10
83606240	T40	62	24	22	65	10
83606245	T45	62	24	22	70	10
83606250	T50	62	24	22	70	10
83606255	T55	62	24	22	80	10
83606260	T60	62	24	24	105	10
83606270	T70	62	24	24	125	10

BIT SOCKET TX 1/2", 100MML

DIN NO. 3120

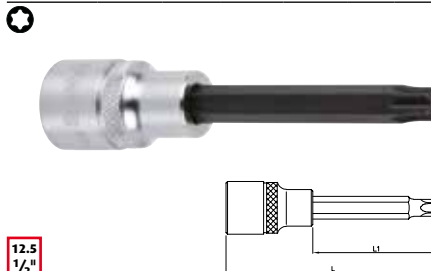

12.5
1/2"

ART. NO.	SIZE	L(MM)	L1(MM)	D(MM)	G	PCS/BAG
83610020	T20	100	62	22	84	10
83610025	T25	100	62	22	84	10
83610027	T27	100	62	22	84	10
83610030	T30	100	62	22	86	10
83610040	T40	100	62	22	84	10
83610045	T45	100	62	22	86	10
83610050	T50	100	62	22	86	10
83610055	T55	100	62	22	104	10
83610060	T60	100	62	24	142	10
83610070	T70	100	62	24	168	10
83610080	T80	100	62	24	292	10
83610090	T90	100	62	24	292	10
836100100	T100	100	62	24	358	10

TX BIT SOCKET 1/2", 140MML

DIN NO. 3120

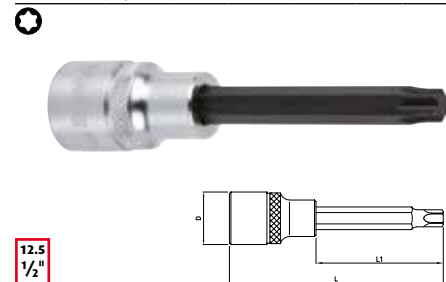

12.5
1/2"

ART. NO.	SIZE	L(MM)	L1(MM)	D(MM)	G	PCS/BAG
83614040	T40	140	102	22	120	10
83614045	T45	140	102	22	121	10
83614050	T50	140	102	22	121	10
83614055	T55	140	102	22	149	10
83614060	T60	140	102	24	180	10
83614070	T70	140	102	24	217	10

BIT SOCKET TX TAMPERPROOF 1/2"

DIN NO. 3120

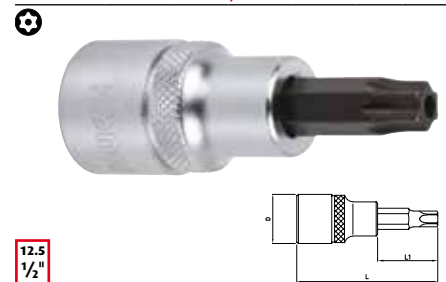

12.5
1/2"

ART. NO.	SIZE	L(MM)	L1(MM)	D(MM)	G	PCS/BAG
83706220	T20H	62	24	22	65	10
83706225	T25H	62	24	22	65	10
83706227	T27H	62	24	22	65	10
83706230	T30H	62	24	22	65	10
83706240	T40H	62	24	22	70	10
83706245	T45H	62	24	22	70	10
83706250	T50H	62	24	22	70	10
83706255	T55H	62	24	22	80	10
83706260	T60H	62	24	24	105	10
83706270	T70H	62	24	24	120	10

BIT SOCKET TX TAMPERPROOF 1/2", 100MML

DIN NO. 3120

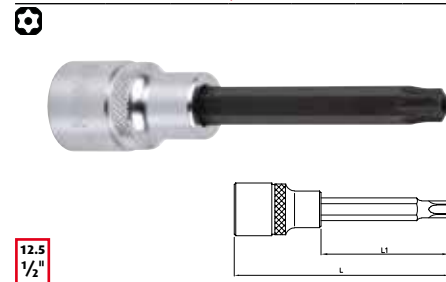

12.5
1/2"

ART. NO.	SIZE	L(MM)	L1(MM)	D(MM)	G	PCS/BAG
83710020	T20H	100	62	22	84	10
83710025	T25H	100	62	22	84	10
83710027	T27H	100	62	22	84	10
83710030	T30H	100	62	22	86	10
83710040	T40H	100	62	22	84	10
83710045	T45H	100	62	22	86	10
83710050	T50H	100	62	22	86	10
83710055	T55H	100	62	22	104	10
83710060	T60H	100	62	24	140	10
83710070	T70H	100	62	24	166	10
83710080	T80H	100	62	24	292	10

BIT SOCKET SPLINE 1/2"

DIN NO. 3120



12.5
1/2"

ART. NO.	SIZE	L(MM)	L1(MM)	D(MM)	G	PCS/BAG
83806205	M5	62	24	22	70	10
83806206	M6	62	24	22	70	10
83806208	M8	62	24	22	70	10
83806209	M9	62	24	22	75	10
83806210	M10	62	24	22	80	10
83806212	M12	62	24	24	105	10
83806214	M14	62	24	24	120	10
83806216	M16	62	24	24	130	10
83806216T	M16T	62	24	24	125	10

BIT SOCKET SPLINE 1/2", 100MML

DIN NO. 3120

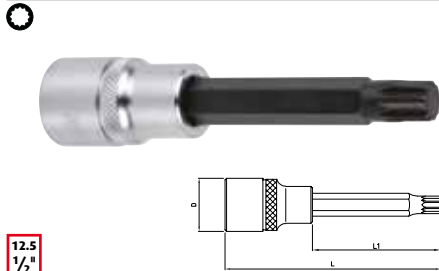

12.5
1/2"

ART. NO.	SIZE	L(MM)	L1(MM)	D(MM)	G	PCS/BAG
83810005	M5	100	62	22	84	10
83810006	M6	100	62	22	84	10
83810008	M8	100	62	22	84	10
83810009	M9	100	62	22	104	10
83810010	M10	100	62	22	102	10
83810012	M12	100	62	24	138	10
83810014	M14	100	62	24	166	10
83810016	M16	100	62	24	184	10
83810016T	M16T	100	62	24	193	10

BIT SOCKET SPLINE 1/2", 140MML

DIN NO. 3120

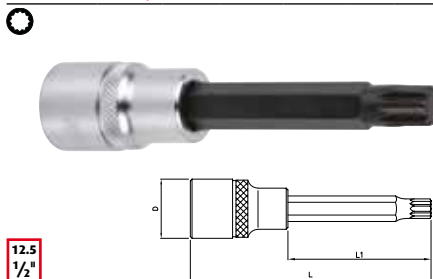

12.5
1/2"

ART. NO.	SIZE	L(MM)	L1(MM)	D(MM)	G	PCS/BAG
83814010	10	140	102	22	148	10
83814012	12	140	102	24	178	10
83814014	14	140	102	24	215	10

BIT SOCKET SPLINE 1/2", 800MML

DIN NO. 3120

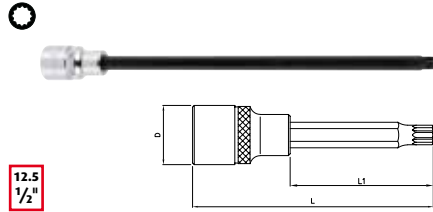

12.5
1/2"

ART. NO.	SIZE	L(MM)	L1(MM)	D(MM)	G	PCS/BAG
83880008	M8	800	762	22	90	10
83880010	M10	800	762	22	90	10

IMPACT BALL JOINT SOCKET 1/2" BIT 130MML

DIN NO. 3121

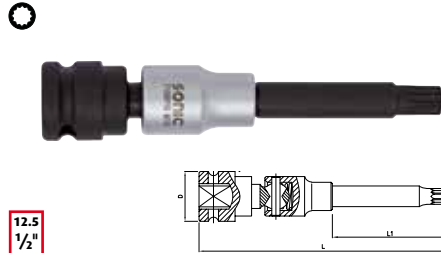

12.5
1/2"

ART. NO.	SIZE	L(MM)	L1(MM)	D(MM)	G	PCS/BAG
7150108	M8	130	92	22	180	10
7150110	M10	130	92	22	180	10

BIT SOCKET RIBE 1/2"

DIN NO. 3120

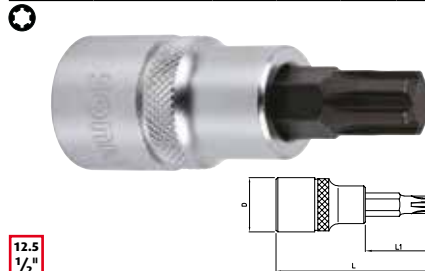

12.5
1/2"

ART. NO.	SIZE	L(MM)	L1(MM)	D(MM)	G	PCS/BAG
83906205	M5	62	24	22	68	10
83906206	M6	62	24	22	70	10
83906207	M7	62	24	22	70	10
83906208	M8	62	24	22	70	10
83906209	M9	62	24	22	80	10
83906210	M10	62	24	22	80	10
83906211	M10-1	62	24	22	80	10
83906212	M12	62	24	24	105	10
83906213	M13	62	24	24	120	10
83906214	M14	62	24	24	120	10
83906216	M16	62	24	24	130	10

BIT SOCKET RIBE 1/2", 100MML

DIN NO. 3120

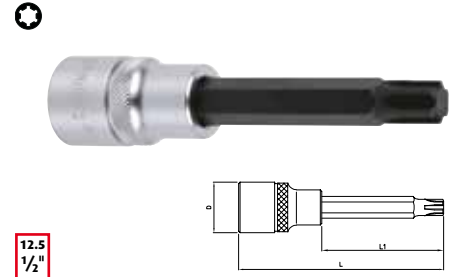

12.5
1/2"

ART. NO.	SIZE	L(MM)	L1(MM)	D(MM)	G	PCS/BAG
83910005	M5	100	62	22	85	10
83910006	M6	100	62	22	86	10
83910007	M7	100	62	22	86	10
83910008	M8	100	62	22	86	10
83910009	M9	100	62	22	102	10
83910010	M10	100	62	22	105	10
83910012	M12	100	62	24	140	10
83910013	M13	100	62	24	165	10
83910014	M14	100	62	24	165	10
83910016	M16	100	62	27	193	10

IMPACT RIBE 1/2", ONE-PIECE 78MML

DIN NO. 3121

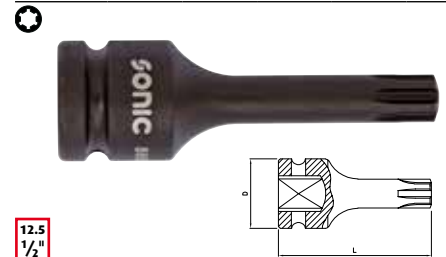

12.5
1/2"

ART. NO.	SIZE	L(MM)	D(MM)	G	PCS/BAG
86907805	M5	78	25	78	10
86907806	M6	78	25	76	10
86907807	M7	78	25	82	10
86907808	M8	78	25	84	10
86907809	M9	78	25	92	10
86907810	M10	78	25	96	10
86907812	M12	78	25	110	10
86907813	M13	78	25	120	10
86907814	M14	78	25	124	10

BIT SOCKET RIBE 1/2", 120MML

DIN NO. 3120

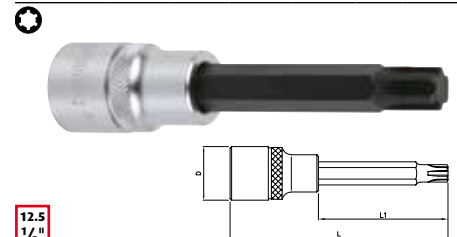

12.5
1/2"

ART. NO.	SIZE	L(MM)	L1(MM)	D(MM)	G	PCS/BAG
83912011	M10-1	120	82	24	127	10

SPECIAL FOR FIAT

BIT SOCKET RIBE 1/2", 140MML

DIN NO. 3120

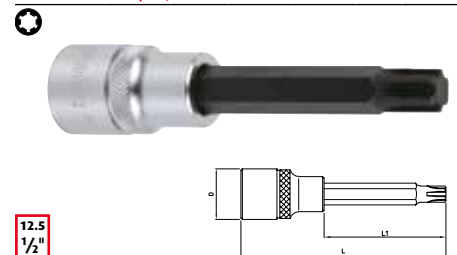

12.5
1/2"

ART. NO.	SIZE	L(MM)	L1(MM)	D(MM)	G	PCS/BAG
83914010	M10	140	102	24	178	10

SPECIAL FOR VW

BIT SOCKET RIBE 1/2", 240MML

DIN NO. 3120

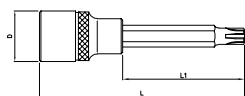

12.5
1/2"

ART. NO.	SIZE	L(MM)	L1(MM)	D(MM)	G	PCS/BAG
83924007	7	240	202	24	190	10
83924008	8	240	202	24	194	10

IMPACT BIT SOCKET SPLINE 1/2", 78MML

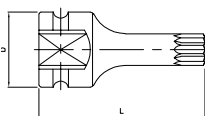

12.5
1/2"

ART. NO.	SIZE	L(MM)	D(MM)	G	PCS/BAG
86807818	18	78	25	150	10

BIT SOCKET IMPACT SPLINE 3/4"

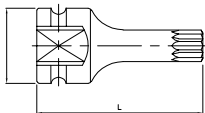

20
3/4"

ART. NO.	SIZE	L(MM)	D(MM)	G	PCS/BAG
87810518	M18	105	40	396	1



THE BITS WILL BE DELIVERED
IN A 5 PIECES BLISTER PACKAGE

BIT PH 1/4", 25MML

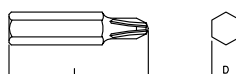

6.3
1/4"

ART. NO.	SIZE	L(MM)	D(MM)	G	PCS/BAG
9112501	PH.1	25	6.3	4	5
9112502	PH.2	25	6.3	4	5
9112503	PH.3	25	6.3	6	5

BIT SLOTTED 1/4", 25MML

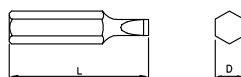

6.3
1/4"

ART. NO.	SIZE	L(MM)	D(MM)	G	PCS/BAG
9132503	3	25	6.3	4	5
9132504	4	25	6.3	4	5
9132505	5	25	6.3	4	5
9132506	6	25	6.3	6	5

BIT HEX 1/4", 25MML

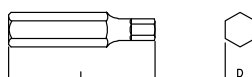

6.3
1/4"

ART. NO.	SIZE	L(MM)	D(MM)	G	PCS/BAG
9142503	3	25	6.3	4	5
9142504	4	25	6.3	4	5
9142505	5	25	6.3	6	5

BIT SPLINE 1/4", 25MML

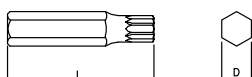

ART. NO.	SIZE	L(MM)	D(MM)	G	PCS/BAG
9182504	M4	25	6.3	14	5
9182505	M5	25	6.3	14	5

BIT PH 5/16", 30MML

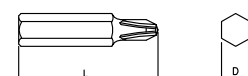

ART. NO.	SIZE	L(MM)	D(MM)	G	PCS/BAG
9213001	PH.1	30	7.9	10	5
9213002	PH.2	30	7.9	10	5
9213003	PH.3	30	7.9	10	5
9213004	PH.4	30	7.9	10	5

BIT PH 5/16", 36MML

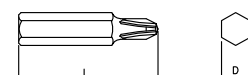

ART. NO.	SIZE	L(MM)	D(MM)	G	PCS/BAG
9213601	PH.1	36	7.9	12	5
9213602	PH.2	36	7.9	12	5
9213603	PH.3	36	7.9	12	5
9213604	PH.4	36	7.9	12	5

BIT PZ 5/16", 30MML

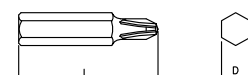

ART. NO.	SIZE	L(MM)	D(MM)	G	PCS/BAG
9223002	PZ.2	30	7.9	10	5
9223003	PZ.3	30	7.9	10	5
9223004	PZ.4	30	7.9	12	5

BIT SLOTTED 5/16", 30MML

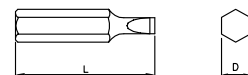

ART. NO.	SIZE	L(MM)	D(MM)	G	PCS/BAG
9233008	8	30	7.9	10	5
9233010	10	30	7.9	16	5
9233012	12	30	7.9	20	5

BIT SLOTTED 5/16", 36MML

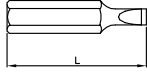

ART. NO.	SIZE	L(MM)	D(MM)	G	PCS/BAG
9233605	5	36	7.9	12	5
9233606	6	36	7.9	12	5
9233608	8	36	7.9	14	5
9233610	10	36	7.9	14	5
9233612	12	36	7.9	16	5

BIT HEX 5/16", 30MML

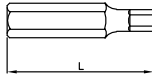

ART. NO.	SIZE	L(MM)	D(MM)	G	PCS/BAG
9243007	7	30	7.9	14	5
9243008	8	30	7.9	14	5
9243010	10	30	7.9	14	5
9243012	12	30	7.9	16	5
9243014	14	30	7.9	26	5

BIT SPLINE 5/16", 30MM

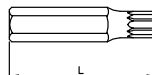

ART. NO.	SIZE	L(MM)	D(MM)	G	PCS/BAG
9283006	M6	30	7.9	14	5
9283008	M8	30	7.9	14	5
9283010	M10	30	7.9	14	5

BIT HEX 5/16", 36MML

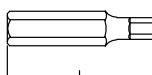

ART. NO.	SIZE	L(MM)	D(MM)	G	PCS/BAG
9243604	4	36	7.9	12	5
9243605	5	36	7.9	14	5
9243606	6	36	7.9	14	5
9243608	8	36	7.9	14	5

BIT TX 5/16", 30MML



ART. NO.	SIZE	L(MM)	D(MM)	G	PCS/BAG
9263040	T40	30	7.9	10	5
9263045	T45	30	7.9	12	5
9263050	T50	30	7.9	12	5
9263055	T55	30	7.9	14	5

BIT HEX 10MM, 30MML

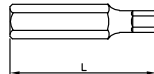

ART. NO.	SIZE	L(MM)	D(MM)	G	PCS/BAG
9343004	4	30	10	14	5
9343005	5	30	10	14	5
9343006	6	30	10	14	5
9343007	7	30	10	14	5
9343008	8	30	10	18	5
9343010	10	30	10	20	5
9343012	12	30	10	24	5

BIT HEX 10MM, 75MML

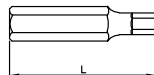

ART. NO.	SIZE	L(MM)	D(MM)	G	PCS/BAG
9347504	4	75	10	42	5
9347505	5	75	10	38	5
9347506	6	75	10	44	5
9347507	7	75	10	46	5
9347508	8	75	10	46	5
9347510	10	75	10	50	5
9347512	12	75	10	64	5

BIT TX 10MM, 30MML

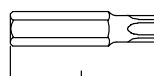

ART. NO.	SIZE	L(MM)	D(MM)	G	PCS/BAG
9363020	T20	30	10	12	5
9363025	T25	30	10	12	5
9363030	T30	30	10	14	5
9363040	T40	30	10	14	5
9363045	T45	30	10	16	5
9363050	T50	30	10	16	5
9363055	T55	30	10	16	5
9363060	T60	30	10	18	5

BIT TX 10MM, 75MML

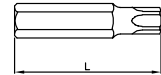

ART. NO.	SIZE	L(MM)	D(MM)	G	PCS/BAG
9367520	T20	75	10	22	5
9367525	T25	75	10	40	5
9367530	T30	75	10	42	5
9367540	T40	75	10	44	5
9367545	T45	75	10	44	5
9367550	T50	75	10	46	5
9367555	T55	75	10	48	5
9367560	T60	75	10	66	5

BIT SPLINE 10MM, 30MML

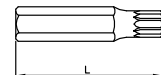

ART. NO.	SIZE	L(MM)	D(MM)	G	PCS/BAG
9383005	M5	30	10	14	5
9383006	M6	30	10	14	5
9383008	M8	30	10	16	5
9383010	M10	30	10	18	5
9383012	M12	30	10	20	5

BIT SPLINE 10MM, 75MML



ART. NO.	SIZE	L(MM)	D(MM)	G	PCS/BAG
9387505	M5	75	10	42	5
9387506	M6	75	10	42	5
9387508	M8	75	10	44	5
9387510	M10	75	10	46	5
9387512	M12	75	10	54	5

SCREWDRIVER TRY ME



ART. NO.	L(MM)	D1(MM)	D2(MM)	W(MM)	G	PCS/BAG
47828	335	40,5	29	40,5	220	1

PROMOTIONAL ITEMS

75101



SONIC TEAM CAP

75115



KEY RING SONIC SOCKET

75166



SONIC KEY CORD

75190



TOOL CABINET WITH BLUETOOTH SPEAKER

75184



SONIC MEMO BLOCK 100 X 74MM

48134



LITHIUM POLYMER POWER BANK

75191



SONIC MEMO BLOCK 100 X 100 X 100MM

75185



SONIC FLAG 11"

75104



SONIC CATALOGUE

75194



SONIC TENT 3 X 4.5M

ART. NO.	CONTENTS
75186	SONIC TENT (FRAME) 3 X 4.5M
75187	SONIC TENT (CLOTH) 3 X 4.5M

75195



SONIC TENT 3 X 3M

ART. NO.	CONTENTS
75188	SONIC TENT (FRAME) 3 X 3M
75189	SONIC TENT (CLOTH) 3 X 3M

75193



DISC RATCHET 1/4", 72 TEETH GIVE AWAY (BLACK)

47828



SCREWDRIVER TRY ME

75103



SONIC TEAM SHIRT

751...



SONIC JACKET

- ART. NO. 75173 SONIC JACKET S (WOMEN)
- ART. NO. 75174 SONIC JACKET M (WOMEN)
- ART. NO. 75175 SONIC JACKET L (WOMEN)
- ART. NO. 75176 SONIC JACKET XL (WOMEN)
- ART. NO. 75177 SONIC JACKET S (MEN)
- ART. NO. 75178 SONIC JACKET M (MEN)
- ART. NO. 75179 SONIC JACKET L (MEN)
- ART. NO. 75180 SONIC JACKET XL (MEN)
- ART. NO. 75181 SONIC JACKET XXL (MEN)

4802...



SONIC JACKET

ART. NO.	CONTENTS
48027	SONIC JACKET 'ASPEN' M (MEN)
48028	SONIC JACKET 'ASPEN' L (MEN)
48029	SONIC JACKET 'ASPEN' XL (MEN)

200804



SAMPLE SET SONIC, 8PCS. BMCS

Warranty professional use

SONIC EQUIPMENT B.V. OR ITS ASSIGNS (“SONIC”) PROVIDES THE FOLLOWING WARRANTY TO CUSTOMERS WHO PURCHASE TOOLS AND EQUIPMENT FROM AUTHORIZED SONIC DISTRIBUTION CHANNELS FOR USE IN THEIR PROFESSION (“BUYER”).

SONIC WARRANTS THE SONIC BRAND PRODUCTS AGAINST DEFECTS IN WORKMANSHIP AND MATERIALS FOR A DURATION DESCRIBED IN EACH PRODUCT’S WARRANTY CODE.

THE WARRANTY DURATION DEPENDS UPON THE NATURE OF THE PRODUCT. IF THE PRODUCT INFORMATION FOR PURCHASED PRODUCT DOES NOT INCLUDE A WARRANTY STATEMENT WITH THE APPLICABLE DURATION OR PRIOR TO THE PRODUCT PURCHASE, BUYER CAN OBTAIN THE PRODUCT WARRANTY CODE AND WARRANTY DURATION FROM THE SELLING SONIC DEALER OR REPRESENTATIVE OR BY WRITING SONIC AT THE ADDRESS PROVIDED AT THE END OF THIS WARRANTY STATEMENT.

CONSUMABLE PRODUCTS ARE WARRANTED, AT THE TIME OF SALE, ONLY AGAINST DEFECTS IN WORKMANSHIP OR MATERIALS THAT PREVENT THEIR USE.

CONSUMABLE PRODUCTS ARE GOODS REASONABLY EXPECTED TO BE USED UP OR DAMAGED DURING USE, INCLUDING BUT NOT LIMITED TO DRILL BITS, SAW BLADES, GRINDING DISCS, SANDING DISCS, KNIFE BLADES, FILES, O2 SENSORS AND BATTERIES. THIS WARRANTY ONLY EXTENDS TO THE ORIGINAL BUYER AND CANNOT BE TRANSFERRED OR ASSIGNED.

DURING THE APPLICABLE DURATION OF THE WARRANTY, AT ITS OPINION, SONIC WILL REPAIR OR REPLACE ITS PRODUCTS WHICH FAIL TO GIVE SATISFACTORY SERVICE DUE TO A DEFECT IN WORKMANSHIP OR MATERIALS, OR PROVIDE A REFUND BY REPAYING OR CREDITING BUYER WITH AN AMOUNT EQUAL TO THE PURCHASE PRICE OF SUCH PRODUCTS.

REPAIR, REPLACEMENT OR REFUND SHALL BE AT THE SOLE ELECTION AND EXPENSE OF SONIC, AND IS BUYER’S EXCLUSIVE REMEDY IN PLACE OF ALL OTHER RIGHTS AND REMEDIES. TO OBTAIN WARRANTY SERVICE, RETURN PRODUCTS TO SONIC OR A SONIC DEALER. PROOF OF PURCHASE MUST BE PROVIDED WITH ALL WARRANTY SERVICE REQUESTS. BY REPAIRING OR REPLACING A PRODUCT, OR PROVIDING A REFUND, SONIC DOES NOT WAIVE A CLAIM THAT A PRODUCT NEVERTHELESS HAS BEEN SUBJECT TO ABNORMAL USE.

IN ADDITION TO ANY LIMITATIONS OUTLINED IN WARRANTY STATEMENTS PROVIDED WITH THE PRODUCT, SONIC DOES NOT PROVIDE ANY WARRANTY FOR (1) PRODUCTS LABELLED OTHER THAN SONIC OR (2) PRODUCTS SUBJECTED TO “ABNORMAL USE”. PRODUCTS THAT ARE NOT LABELLED SONIC ARE SUBJECT TO THE WARRANTY PROVIDED BY THE MANUFACTURERS OF THOSE PRODUCTS AND SONIC WILL PASS ALONG ANY SUCH WARRANTIES.

“ABNORMAL USE” INCLUDES MISUSE, ACCIDENT, MODIFICATION, ALTERNATION, UNREASONABLE OR IMPROPER USE, ABUSE, NEGLIGENCE, LACK OF MAINTENANCE, USE IN PRODUCT RELATED SERVICE, OR USE AFTER THE PRODUCT IS SIGNIFICANTLY WORN. ABNORMAL USE OF TOOL STORAGE UNITS ALSO INCLUDES, WITHOUT LIMITATION, SITUATIONS WHEN A UNIT IS PULLED USING A MECHANICAL VEHICLE, ROLLED OVER LARGE DROPS, USED IN A HIGHLY CORROSIVE ENVIRONMENT, USED AS A STEP STOOL, MODIFIED WITH NON SONIC PARTS, OVERLOADED OR MODIFIED IN ANY WAY.

THE FOREGOING WARRANTY IS IN LIEU OF AND EXCLUDES ALL OTHER WARRANTIES NOT EXPRESSLY SET FORTH HEREIN, WHETHER EXPRESS OR IMPLIED BY OPERATION OF LAW OR OTHERWISE, INCLUDING BUT NOT LIMITED TO ANY IMPLIED WARRANTIES OF MERCHANTABILITY OR FITNESS FOR A PARTICULAR PURPOSE AND SETS FORTH THE SOLE AND EXCLUSIVE REMEDY IN CONTRACT, TORT, STRICT LIABILITY OR OTHERWISE, SONIC DOES NOT GRANT ANY OTHER PERSON OR ENTITY PERMISSION TO CREATE FOR IT ANY WARRANTY, LIABILITY OR OBLIGATION IN CONNECTION WITH ITS PRODUCTS.

SONIC AND ITS AFFILIATED COMPANIES SHALL NOT BE LIABLE FOR ANY INCIDENTAL, SPECIAL OR CONSEQUENTIAL LOSSES, COSTS OR DAMAGES INCURRED BY BUYER OR OTHERS, DIRECTLY OR INDIRECTLY ARISING FROM THE SALE, HANDLING OR USE OF THE PRODUCTS, OR FROM ANY OTHER CAUSE WITH RESPECT TO THE PRODUCTS OR THIS WARRANTY, WHETHER SUCH CLAIM IS BASED UPON BREACH OF CONTRACT, BREACH OF WARRANTY, STRICT LIABILITY IN TORT, NEGLIGENCE OR ANY OTHER LEGAL THEORY (INCLUDING WITHOUT LIMITATION, LOST PROFITS, REVENUES, ANTICIPATED SALES, BUSINESS OPPORTUNITIES, GOODWILL, OR INTERRUPTION OF BUSINESS OR OTHER INJURY OR DAMAGE)

TO THE EXTENT ALLOWED BY APPLICABLE LAW, THIS WARRANTY AND ALL RIGHTS AND OBLIGATIONS HEREUNDER, INCLUDING MATTERS OF CONSTRUCTION, VALIDITY AND PERFORMANCE, SHALL BE GOVERNED BY THE LAW, WITHOUT GIVING EFFECT TO THE PRINCIPLES OF CONFLICTS OF LAW THEREOF.

IMPORTANT NOTICE

WE RESERVE THE RIGHT TO MAKE CHANGES IN DESIGN OR CONSTRUCTION AT ANY TIME WITHOUT INCURRING ANY OBLIGATION IN INCORPORATING SUCH CHANGES IN TOOLS OR EQUIPMENT PREVIOUSLY SOLD. WE ALSO RESERVE THE RIGHT TO DISCONTINUE THE MANUFACTURE OR OFFERING FOR SALE THROUGH SONIC DEALERS OF ANY TOOLS OR EQUIPMENT AT SUCH TIME AS WE CONSIDER NECESSARY.

WE CANNOT ACCEPT THE RESPONSIBILITY FOR THE RESULTS OF USING TOOLS WHICH HAVE BEEN ABUSED OR BADLY WORN, SUCH AS PUNCHES AND CHISELS MUSHROOMED BY HAMMER BLOWS, OR THE INCORRECT USE OF TOOLS, OR TOOLS REPAIRED BY OTHERS. THE CATALOGUE IS DISTRIBUTED BY SONIC AND NOT ALL ITEMS MAY BE AVAILABLE IN EACH COUNTRY. FOR DETAILED INFORMATION ABOUT THE AVAILABILITY AND PRICING, PLEASE CONTACT YOUR LOCAL SONIC REPRESENTATIVE.

TOOL DIMENSION ACCURACY

DIMENSIONS SHOWN IN THIS CATALOGUE HAVE BEEN ROUNDED TO THE NEAREST FRACTIONAL SIZE OR NEAREST TENTH MILLIMETRE AND ARE NOT EXACT PRODUCT SPECIFICATIONS. ASK YOUR SONIC REPRESENTATIVE FOR PRODUCT SPECIFICATIONS IF REQUIRED.



CONVERSION TABLE FROM INCHES TO MILLIMETRES

CONVERSION EXAMPLE FROM MM TO INCHES: 69,850 MM = 2.3/4"

CONVERSION EXAMPLE FROM INCHES TO MM: 4.1/2" = 114,300 MM

INCHES	MM	1	2	3	4	5	6	7	8	9
		MILLIMETRES								
0	0	25,400	50,800	76,200	101,600	127,000	152,400	177,800	203,200	228,600
1/64	0,397	25,797	51,197	76,597	101,997	127,397	152,797	178,197	203,597	228,997
1/32	0,794	26,194	51,594	76,994	102,394	127,794	153,194	178,594	203,994	229,394
3/64	1,191	26,591	51,991	77,391	102,791	128,191	153,591	178,991	204,391	229,791
1/16	1,588	26,988	52,388	77,788	103,188	128,588	153,988	179,388	204,788	230,188
5/64	1,984	27,384	52,784	78,184	103,584	128,984	154,384	179,784	205,184	230,584
3/32	2,381	27,781	53,181	78,581	103,981	129,381	154,781	180,181	205,581	230,981
7/64	2,778	28,178	53,578	78,978	104,378	129,778	155,178	180,578	205,978	231,378
1/8	3,175	28,575	53,975	79,375	104,775	130,175	155,575	180,975	206,375	231,775
9/64	3,572	28,972	54,372	79,772	105,172	130,572	155,972	181,372	206,772	232,172
5/32	3,969	29,369	54,769	80,169	105,569	130,969	156,369	181,769	207,169	232,569
11/64	4,366	29,766	55,166	80,566	105,966	131,366	156,766	182,166	207,566	232,966
3/16	4,762	30,162	55,562	80,962	106,362	131,762	157,162	182,562	207,962	233,362
13/64	5,159	30,559	55,959	81,359	106,759	132,159	157,559	182,959	208,359	233,759
7/32	5,556	30,956	56,356	81,756	107,156	132,556	157,956	183,356	208,756	234,156
15/64	5,953	31,353	56,753	82,153	107,553	132,953	158,353	183,753	209,153	234,553
1/4	6,35	31,750	57,150	82,550	107,950	133,350	158,750	184,150	209,550	234,950
17/64	6,747	32,147	57,547	82,947	108,347	133,747	159,147	184,547	209,947	235,347
9/32	7,144	32,544	57,944	83,344	108,744	134,144	159,544	184,944	210,344	235,744
19/64	7,541	32,941	58,341	83,741	109,141	134,541	159,941	185,341	210,741	236,141
5/16	7,938	33,338	58,738	84,138	109,538	134,938	160,338	185,738	211,138	236,538
21/64	8,334	33,734	59,134	84,534	109,934	135,334	160,734	186,134	211,534	236,934
11/32	8,731	34,131	59,531	84,931	110,331	135,731	161,131	186,531	211,931	237,331
23/64	9,128	34,528	59,928	85,328	110,728	136,128	161,528	186,928	212,328	237,728
3/8	9,525	34,925	60,325	85,725	111,125	136,525	161,925	187,325	212,725	238,125
25/64	9,922	35,322	60,722	86,122	111,522	136,922	162,322	187,722	213,122	238,522
13/32	10,319	35,719	61,119	86,519	111,919	137,319	162,719	188,119	213,519	238,919
27/64	10,716	36,116	61,516	86,916	112,316	137,716	163,116	188,516	213,916	239,316
7/16	11,112	36,512	61,912	87,312	112,712	138,112	163,512	188,912	214,312	239,712
29/64	11,509	36,909	62,309	87,709	113,109	138,509	163,909	189,309	214,709	240,109
15/32	11,906	37,306	62,706	88,106	113,506	138,906	164,306	189,706	215,106	240,506
31/64	12,303	37,703	63,103	88,503	113,903	139,303	164,703	190,103	215,503	240,903
1/2	12,7	38,100	63,500	88,900	114,300	139,700	165,100	190,500	215,900	241,300
33/64	13,097	38,497	63,897	89,297	114,697	140,097	165,497	190,897	216,297	241,697
17/32	13,494	38,894	64,294	89,694	115,094	140,494	165,894	191,294	216,694	242,094
35/64	13,891	39,291	64,691	90,091	115,491	140,891	166,291	191,691	217,091	242,491
9/16	14,288	39,688	65,088	90,488	115,888	141,288	166,688	192,088	217,488	242,888
37/64	14,684	40,084	65,484	90,884	116,284	141,684	167,084	192,484	217,884	243,284
19/32	15,081	40,481	65,881	91,281	116,681	142,081	167,481	192,881	218,281	243,681
39/64	15,478	40,878	66,278	91,678	117,078	142,478	167,878	193,278	218,678	244,078
5/8	15,875	41,275	66,675	92,075	117,475	142,875	168,275	193,675	219,075	244,475
41/64	16,272	41,672	67,072	92,472	117,872	143,272	168,672	194,072	219,472	244,872
21/32	16,669	42,069	67,469	92,869	118,269	143,669	169,069	194,469	219,869	245,269
43/64	17,066	42,466	67,866	93,266	118,666	144,066	169,466	194,866	220,266	245,666
11/16	17,462	42,862	68,262	93,662	119,062	144,462	169,862	195,262	220,662	246,062
45/64	17,859	43,259	68,659	94,059	119,459	144,859	170,259	195,659	221,059	246,459
23/32	18,256	43,656	69,056	94,456	119,856	145,256	170,656	196,056	221,456	246,856
47/64	18,653	44,053	69,453	94,853	120,253	145,653	171,053	196,453	221,853	247,253
3/4	19,05	44,450	69,850	95,250	120,650	146,050	171,450	196,850	222,250	247,650
49/64	19,447	44,847	70,247	95,647	121,047	146,447	171,847	197,247	222,647	248,047
25/32	19,844	45,244	70,644	96,044	121,444	146,844	172,244	197,644	223,044	248,444
51/64	20,241	45,641	71,041	96,441	121,841	147,241	172,641	198,041	223,441	248,841
13/16	20,638	46,038	71,438	96,838	122,238	147,638	173,038	198,438	223,838	249,238
53/64	21,034	46,434	71,834	97,234	122,634	148,034	173,434	198,834	224,234	249,634
27/32	21,431	46,831	72,231	97,631	123,031	148,431	173,831	199,231	224,631	250,031
55/64	21,828	47,228	72,628	98,028	123,428	148,828	174,228	199,628	225,028	250,428
7/8	22,225	47,625	73,025	98,425	123,825	149,225	174,625	200,025	225,425	250,825
57/64	22,622	48,022	73,422	98,822	124,222	149,622	175,022	200,422	225,822	251,222
29/32	23,019	48,419	73,819	99,219	124,619	150,019	175,419	200,819	226,219	251,619
59/64	23,416	48,816	74,216	99,616	125,016	150,416	175,816	201,216	226,616	252,016
15/16	23,812	49,212	74,612	100,012	125,412	150,812	176,212	201,612	227,012	252,412
61/64	24,209	49,609	75,009	100,409	125,809	151,209	176,609	202,009	227,409	252,809
31/32	24,606	50,006	75,406	100,806	126,206	151,606	177,006	202,406	227,806	253,206
63/64	25,003	50,403	75,803	101,203	126,603	152,003	177,403	202,803	228,203	253,603

CONVERSION TABLES FOR TORQUE WRENCHES

CONVERSION FACTORS

UNIT	SI UNIT			METRIC UNIT		USA/GB UNIT		
	CNM	DNM	NM	CMKG	MKG	FT.LB.	IN.LB	IN.OZ
1 CNM	1,0000	0,1000	0,0100	0,1020	0,0010	0,0074	0,0885	1,4161
1 DNM	10,0000	1,0000	0,1000	1,0197	0,0102	0,0738	0,8851	14,1612
1 NM	100,0000	10,0000	1,0000	10,1972	0,1020	0,7376	8,8508	141,6123
1 CMKG	9,8067	0,9807	0,0981	1,0000	0,0100	0,0723	0,8680	13,8874
1 MKG	980,6650	98,0665	9,8067	100,0000	1,0000	7,2330	86,7964	1388,7422
1 FT.LB	135,5818	13,5581	1,3558	13,8255	0,1383	1,0000	12,0000	192,0000
1 IN.LB	11,2985	1,1298	0,1130	1,1521	0,0115	0,0833	1,0000	16,0000
1 IN.OZ	0,7062	0,0706	0,0071	0,0720	0,0007	0,0052	0,0625	1,0000

CONVERSION NM TO MKG											1 NM = 0,10197 MKG
NM	0	1	2	3	4	5	6	7	8	9	
0	0,00	0,10	0,20	0,31	0,41	0,51	0,61	0,71	0,82	0,92	
10	1,02	1,12	1,22	1,33	1,43	1,53	1,63	1,73	1,84	1,94	
20	2,04	2,14	2,24	2,35	2,45	2,55	2,65	2,75	2,86	2,96	
30	3,06	3,16	3,26	3,37	3,47	3,57	3,67	3,77	3,87	3,98	
40	4,08	4,18	4,28	4,38	4,49	4,59	4,69	4,79	4,89	5,00	
50	5,10	5,20	5,30	5,40	5,51	5,61	5,71	5,81	5,91	6,02	
60	6,12	6,22	6,32	6,42	6,53	6,63	6,73	6,83	6,93	7,04	
70	7,14	7,24	7,34	7,44	7,55	7,65	7,75	7,85	7,95	8,06	
80	8,16	8,26	8,36	8,46	8,57	8,67	8,77	8,87	8,97	9,08	
90	9,18	9,28	9,38	9,48	9,59	9,69	9,79	9,89	9,99	10,10	
100	10,2	10,3	10,4	10,5	10,6	10,71	10,81	10,91	11,01	11,11	

CONVERSION MKG TO NM											1 MKG = 9,80665 NM
MKG	0	1	2	3	4	5	6	7	8	9	
0	0	9,81	19,61	29,42	39,23	49,03	58,84	68,65	78,45	88,26	
10	98,07	107,87	117,68	127,49	137,29	147,10	156,91	166,71	176,52	186,33	
20	196,13	205,94	215,75	225,55	235,36	245,17	254,97	264,78	274,59	284,39	
30	294,2	304,01	313,81	323,62	333,43	343,23	353,04	362,85	372,65	382,46	
40	392,27	402,07	411,88	421,69	431,49	441,30	451,11	460,91	470,72	480,53	
50	490,33	500,14	509,95	519,75	529,56	539,37	549,17	558,98	568,79	578,59	
60	588,4	598,21	608,01	617,82	627,63	637,43	647,24	657,05	666,85	676,66	
70	686,47	696,27	706,08	715,89	725,69	735,50	745,31	755,11	764,92	774,73	
80	784,53	794,34	804,15	813,95	823,76	833,57	843,37	853,18	862,99	872,79	
90	882,6	892,41	902,21	912,02	921,83	931,63	941,44	951,25	961,05	970,86	
100	980,67	990,47	1000,28	1010,08	1019,89	1029,70	1039,50	1059,12	1059,12	1068,92	

CONVERSION NM TO FT.LB.											1 NM = 0,73756 FT.LB.
NM	0	1	2	3	4	5	6	7	8	9	
0	0,00	0,74	1,48	2,21	2,95	3,69	4,43	5,16	5,90	6,64	
10	7,38	8,11	8,85	9,59	10,33	11,06	11,80	12,54	13,28	14,01	
20	14,75	15,49	16,23	16,96	17,7	18,44	19,18	19,91	20,65	21,39	
30	22,13	22,86	23,60	24,34	25,08	25,81	26,55	27,29	28,03	28,76	
40	29,50	30,24	30,98	31,72	32,45	33,19	33,93	34,67	35,40	36,14	
50	36,88	37,62	38,35	39,09	39,83	40,57	41,30	42,04	42,78	43,52	
60	44,25	44,99	45,73	46,47	47,2	47,94	48,68	49,42	50,15	50,89	
70	51,63	52,37	53,10	53,84	54,58	55,32	56,05	56,79	57,53	58,27	
80	59,00	59,74	60,48	61,22	61,96	62,69	63,43	64,17	64,91	65,64	
90	66,38	67,12	67,86	68,59	69,33	70,07	70,81	71,54	72,28	73,02	
100	73,76	74,49	75,23	75,97	76,71	77,44	78,18	78,92	79,66	80,39	

CONVERSION FT.LB TO NM											1 FT.LB. -> 1,35581 NM
FT.LB.	0	1	2	3	4	5	6	7	8	9	
0	0,00	1,36	2,71	4,07	5,42	6,78	8,13	9,49	10,85	12,20	
10	13,56	14,91	16,27	17,63	18,98	20,34	21,69	23,05	24,40	25,76	
20	27,12	28,47	29,83	31,18	32,54	33,90	35,25	36,61	37,96	39,32	
30	40,67	42,03	43,39	44,74	46,10	47,45	48,81	50,16	51,52	52,88	
40	54,23	55,59	56,94	58,30	59,66	61,01	62,37	63,72	65,08	66,43	
50	67,79	69,15	70,50	71,86	73,21	74,57	75,93	77,28	78,64	79,99	
60	81,35	82,70	84,06	85,42	86,77	88,13	89,48	90,84	92,20	93,55	
70	94,91	96,26	97,62	98,97	100,33	101,69	103,04	104,40	105,75	107,11	
80	108,46	109,82	111,18	12,53	13,89	115,24	116,60	117,96	119,31	120,67	
90	122,02	123,38	124,73	26,09	27,45	128,80	130,16	131,51	132,87	134,23	
100	135,58	136,94	138,29	39,65	41,00	142,36	143,72	145,07	146,43	147,78	

CONVERSION IN.LB. TO NM											1 NM = 8,85077 IN.LB.
Nm	0	1	2	3	4	5	6	7	8	9	
0	0,00	8,85	17,70	26,55	35,40	44,25	53,10	61,96	70,81	79,66	
10	88,51	97,36	106,21	115,06	123,91	132,76	141,61	150,46	159,31	168,16	
20	177,02	185,87	194,72	203,57	212,42	221,27	230,12	238,97	247,82	256,67	
30	265,52	274,37	283,22	292,08	300,93	309,78	318,63	327,48	336,33	345,18	
40	354,03	362,88	371,73	380,58	389,43	398,28	407,14	415,99	424,84	433,69	
50	442,54	451,39	460,24	469,09	477,94	486,79	495,64	504,49	513,34	522,20	
60	531,05	539,90	548,75	557,60	566,45	575,30	584,15	593,00	601,85	610,70	
70	619,55	628,40	637,26	646,11	654,96	663,81	672,66	681,51	690,36	699,21	
80	708,06	716,91	725,76	734,61	743,46	752,32	761,17	770,02	778,87	787,72	
90	796,57	805,42	814,27	823,12	831,97	840,82	849,67	858,52	867,38	876,23	
100	885,08	893,93	902,78	911,63	920,48	929,33	938,18	947,03	955,88	964,73	

CONVERSION NM TO IN.LB.											1 IN.LB. -> 0,11298 NM
in.lb.	0	1	2	3	4	5	6	7	8	9	
0	0,00	0,11	0,23	0,34	0,45	0,56	0,68	0,79	0,90	1,02	
10	1,13	1,24	1,36	1,47	1,58	1,69	1,81	1,92	2,03	2,15	
20	2,26	2,37	2,49	2,60	2,71	2,82	2,94	3,05	3,16	3,28	
30	3,39	3,50	3,62	3,73	3,84	3,95	4,07	4,18	4,29	4,41	
40	4,52	4,63	4,75	4,86	4,97	5,08	5,20	5,31	5,42	5,54	
50	5,65	5,76	5,87	5,99	6,10	6,21	6,33	6,44	6,55	6,67	
60	6,78	6,89	7,00	7,12	7,23	7,34	7,46	7,57	7,68	7,80	
70	7,91	8,02	8,13	8,25	8,36	8,47	8,59	8,70	8,81	8,93	
80	9,04	9,15	9,26	9,38	9,49	9,60	9,72	9,83	9,94	10,06	
90	10,17	10,28	10,39	10,51	10,62	10,73	10,85	10,96	11,07	11,19	
100	11,30	11,41	11,52	11,64	11,75	11,86	11,98	12,09	12,20	12,31	

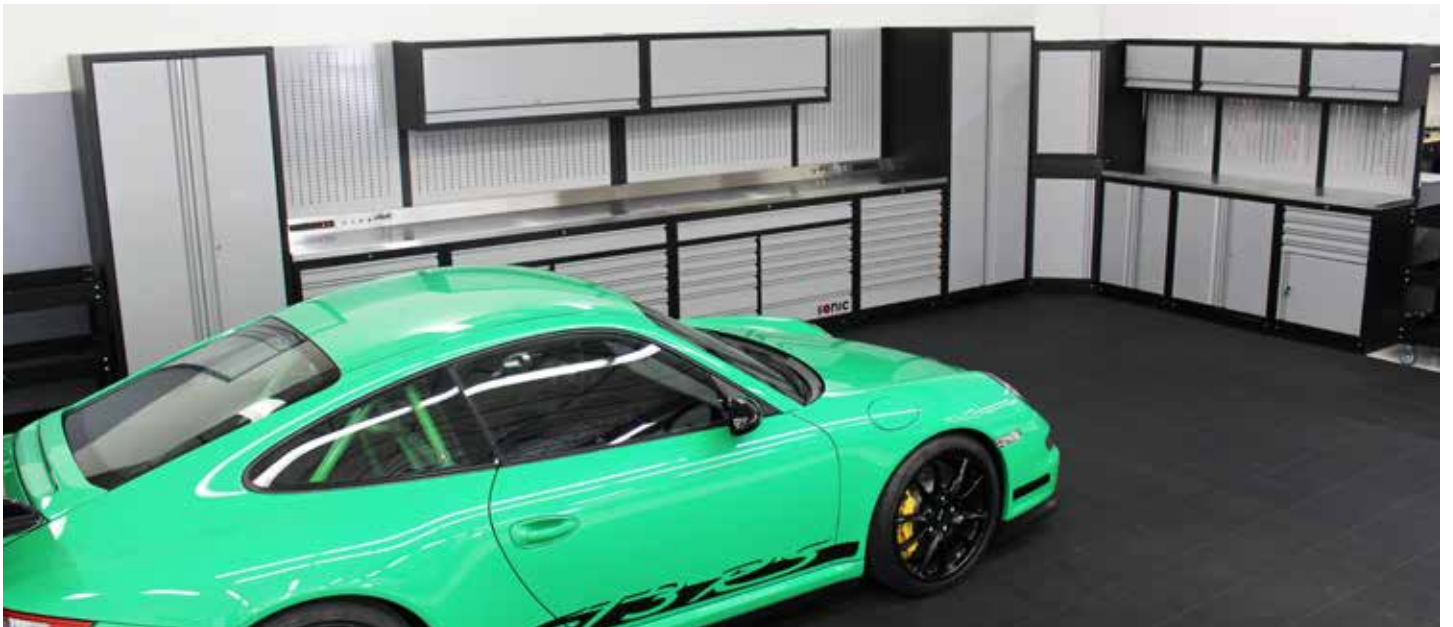

PORSCHE C.J. WILSON, USA



**WORKPLACE JOHAN MEURE
PURMEREND, THE NETHERLANDS**





**WORKPLACE
VOLKSWAGEN, GERMANY**



**WORKPLACE JOHAN MEURE
PURMEREND, THE NETHERLANDS**

Index

1							
100301	130	18603...	281	249...	265	309302	134
100301	173	18613...	281	258...	266	309401	163
100501	156	19501...	259			309402	152
100601	157	19502...	259	3		309502	133
100701	156	19601...	259	300301	171	309901	153
100702	156, 247	19602...	259	300302	171	310001	139, 249
100704	156			300303	172	310101	133
100901	156, 247	2		300304	171	310501	134
100902	156, 247	200801	157, 247	300306	178	311101	135
100903	156	200802	157, 247	300307	172	311801	141
100904	156	200804	147, 312	300308	159, 164	313802	132
101001	156	200805	158	300310	171	313902	134
101002	156	200901	157	300402	172	315601	141
101003	156	200902	157, 247	300504	172	316001	132
101004	156	200903	157	300506	171	325...	266
101005	156	201001	157	300601	164	32563...	266
101105	146	201002	157	300602	164	33101...	266
101201	156	201003	157	300603	164	33102...	266
101202	156	201005	157	300605	164	33103...	266
101203	156	201006	157	300814	159, 164	3310417	266
101204	156	201008	157	300816	149	33105...	266
101901	162	201009	157	300817	149	3310617	266
102801	162	201010	157	300818	149	335...	267
103101	162	201012	157	300819	149	33585...	267
103201	162	201013	157	300820	149	33678...	267
103502	146	201014	157	300821	149	33978...	267
104001	146	201015	158	300822	149	339853...	267
104602	146	201201	158	300823	150	345...	268
106105	130	201203	179	300901	172	34590...	268
106303	124	201401	125	300902	158	34690...	268
106304	129, 248	202301	125	300903	158	34990...	268
107403	147	202302	129, 248	300906	159	355...	268
11...	257	202803	147	300908	125	35590...	269
110001	194	203001	125	300910	164		
110201	125	203703	148	301002	158, 247	4	
111...	256	204003	148	301003	158	402001	164
111...S	256	204101	125	301005	159	403201	135
112...	256	204102	129, 248	301006	159	403301	135
112...S	256	206101	163	301007	158	408...	273
112102	130	206102	148	301008	159	411...	273
113...	256	206501	131	301201	158	412...	273
1130...S	257	207601	149	301202	158	41201	273
114602	140	208001	125	301203	158	41202	273
116...	257	213901	131	301204	158	4121...	273
117...	258	214201	131	301302	179	413...	276
120001	195	215...	262	301503	158, 247	414...	273
12425...	258	21550...	262	301504	158, 247	415...	274
12525...	258	215702	132	301601	163	41502...	253, 274
130001	196	216...	262	301603	125	41503...	274
131...	256	216401	140	301702	150	416...	276
131...S	256	21650...	262	301904	150	41701...	275
132...	256	218...	262	302001	173	41702...	274
132...S	256	21850...	262	302003	125	41703...	274
133...	257	219...	252, 262	302004	129, 248	41704...	275
1330...S	257	21950...	252, 262	302005	129, 248	41706...	275
136...	258	221201	141	302104	126	4176...	275
13625...	258	225...	263	302204	126	4177...	274
137...	258	22563...	263	302404	150	418...	275
144230...	258	226...	263	303101	134	419...	275
145230...	258	22663...	264	303805	126	420...	276
15...	256	228...	263	303806	129, 248	4200113	275
151...	256	22863...	263	304201	164	421...	276
153...	257	229...	252, 263	304501	150	422...	253, 273
15301...	257	22963...	252, 263	305605	126	423...	276
16...	256	235...	264	306101	133	425...	253, 273
163...	257	23577...	264	306601	134	426...	274
17320002	257	236...	265	306701	151	427...	253, 275
18403...	281	23677...	265	307301	163	4311165	284
18502...	281	238...	264	307302	135	4311175	284
18503...	281	23877...	265	307603	151	4312180	284
18506...	281	239...	252, 265	308401	142	4312200	284
18601...	281	23977...	252, 265	309101	152	432100	284
		248...	252, 266	309301	139, 249	4321160	284

4321170	284	47002	291	4730415	26	4731703	51
4322160	284	47003	291	47306	44	4731704	51
4322200	284	47004	291	4730670	35	4731705	51
4323275	286	47005	291	47307118	23	4731706	51
4331200	284	47006	291	47308	39	4731707	40
4333270	286	47010	291	47308113	22	4731708	41
4333275	286	47013	291	47309	144	4731709	42
4341145	284	47015	179	4730918	16	4731710	41
4341175	284	47016	257	4730928	16	4731711	51
4341180	284	47017	187	4730938	16	4731713	50
4341190	284	47018	187	4730948	16	4731714	41
4342160	285	47019	187	47310	61	4731715	50
4342200	285	47022	187	4731118	18	47318	59
4342240	285	47023	174	4731128	18	4731801	48
4343200	285	47024	291	4731138	18	4731802	48
4351180	285	47025	187	4731148	18	4731803	48
4351250	285	47026	186	4731196	52	4731804	48
4351300	285	47027	186	4731230	50	4731805	49
4351400	285	47028	291	4731281	46, 47	4731806	49
4352250	285	47029	188	4731301	52	4731807	49
43611	285	4720101	45	4731302	53	4731808	49
43612	285	4720102	45	4731303	53	4731809	47
43613	286	4720103	45	4731304	53	4731810	49
43614	286	4720104	45	4731305	53	4731811	49
4380250	287	4720105	45	4731306	53	4731813	48
4381...	287	47204	56	4731307	53	4731814	48
4382...	287	47205	56	4731308	38	4731815	49
4383...	287	47206	56	4731309	38	4731816	49
4384250	287	47209	57	4731310	39	4731817	47
4385...	287	47209F	57	4731311	40	4731818	47
4386...	287	472095	57	4731312	39	4731819	46
4387250	287	47210	62	4731315	38	4731820	37
4388275	287	47211	55	4731317	39	47319	59
4391175	287	47213	54	4731318	38	47320	59
439300...	286	47214	62	4731355	35	4732013	25
4410265	288	47215	58	4731401	50	47321	59
4450...	288	47216	58	4731402	51	4732110	25
44601280	285	47217	58	4731403	51	47322	57
4471180	285	47218	58	4731404	51	4732355	35
4471250	285	47224	54	4731405	51	4732418	14
4472100	170	47230	55	4731406	51	4732718	19
4472160	285	47231	55	4731407	40	47328	58
4473001	287	47232	55	4731408	41	47329	58
4473002	287	47242	180	4731409	42	4733014	26
4473003	288	47243	58	4731410	41	4733115	17
4473004	288	47244	58	4731411	51	473316	39
4473005	288	47251	55	4731414	41	47334	55
4474001	288	47252	54	4731415	50	47337	59
4474002	288	47253	59	4731416	41	4733716	12
4476001	286	47254	59	4731501	48	47338	59
4476002	286	47257	54	4731502	48	47338114	24
4476004	286	47258	56	4731503	48	47339	59
4476005	286	47259	57	4731504	48	47340	59
4476006	286	47261	58	4731505	49	4734218	20
4476007	286	47262	54	4731506	49	47346	56
451...	288	47264	57	4731507	49	47347	56
4527190	288	47265	59	4731508	49	47348	56
453...	288	47266	59	4731509	47	47350	56
455...	289	47267	55	4731510	49	47353	56
45602	289	47272	42	4731511	49	47364	54
4560201	167	47273	57	4731513	48	47365	59
4560202	167	47275	61	4731514	48	47366	59
4565185	289	47276	43	4731515	49	47368	57
4611200	289	47279	44	4731516	49	47369	55
4611400	289	47280	38	4731517	47	47374	54
4620400	289	47281	60	4731518	47	47376	44
4621000	289	47282	60	4731520	37	47377	44
4631000	289	47283	44	4731601	52	47378	44
466...	289	47284	44	4731602	53	47379	41
46601	289	47288	38	4731603	53	47380	44
467...	289	47289	61	4731604	53	47381	44
46701	290	47290	45	4731605	53	47382	44
46803	290	47291	45	4731606	53	47383	44
46804	290	47292	43	4731607	53	47384	44
46806	290	47295	44	4731608	38	47385	44
46806-1	290	47296	40	4731609	38	47386	62
46807	290	47297	60	4731610	39	47387	62
46807-1	290	47298	60	4731611	40	47389	61
46901	290	4730167	13	4731612	39	47391	59
46902	290	4730196	52	4731613	52	47392	59
46903	290	47302	41	4731614	52	47393	59
46904	290	4730224	26	4731615	38	47394	59
46905	290	4730230	50	4731616	39	47395	56
46911	290	4730281	46, 47	4731617	39	47396	59
46912	290	47303	61	4731618	38, 41	47401	179
46913	290	4730314	52	4731701	50	47402	179
46914	290	4730414	26	4731702	51	47403	179

47404	179	47543	62	47906	292	4821102	204
47410	56	47544	44	47907	293	4821105	204
474109	87	47545	44	47908	293	4821106	204
47411	56	47546	59	47909	293	4821109	204
474116	87	47547	59	47910	293	4821110	205
474119	87	47548	54	47911	293	4821111	205
47412	56	47549	55	47912	293	4821112	205
47414	60	47550	59	480...	200	48212...	168
47415	45	47551	55	48001	198	48213	294
47416	45	47553	59	48002	197	4821301	168
47417	45	47561	57	48003	199	4821302	168
47418	45	47568	57	48004	199	4821303	168
47419	45	47568F	57	48005	198	4821304	168
47420	45	47568S	57	4802...	312	4821305	168
47421	45	47570	180	48023	200	48215...	187
47422	55	47571	180	48025	200	4821511	45
47423	55	47573	57	48104	180	4821512	45
47424	55	47573F	57	48105	180	4821514	45
47425	55	47573S	57	48106	209	4821515	45
47431	39	47580	54	48107	209	4821517	45
47432	39	47581	54	48108	209	4821518	45
47433	43	47600	41	48109	209	4821519	45
47434	61	47601	54	48110	209	48217...	187
47447	44	47602	60	48111	209	4821901	180
47448	44	47603	60	48112	180	4821902	180
47449	44	47604	60	48112...	211	4822010	186
47450	39	47605	56	4811208	211	4822015	186
47451	40	47606	54	4811213	211	482210...	170
47452	60	47607	59	4811214	211	4822101	170
47455	31	47608	59	4811215	211	4822102	289
47456	31	47609	56	4811216	211	4822301	189
47457	30	47610	59	4811217	211	4822302	189
47458	30	47612	139	4811218	211	4822303	189
47459	61	47613	128	4811219	211	4822304	189
47460	62	47614	54	4811220	211	4822305	189
47461	61	47615	54	4811221	211	4822306	189
47462	61	47622	62	4811228	211	4822307	189
47463	61	47623	62	4811241	211	4822308	189
47464	60	47624	62	4811242	211	4822309	189
47465	60	47625	62	4811243	211	4822310	189
47466	60	47630	60	4811244	211	4822311	189
47467	60	47631	57	4811245	211	4822312	189
47468	60	47631F	57	4811254	291	4822313	190
47469	31	47631S	57	4811260	291	4822314	190
47470	31	47632	45	4811262	211	4822315	190
47471	30	47636	55	48113	178	4822316	190
47472	30	47637	60	48114	214	4822317	190
47473	61	47638	45	48115	214	4822318	190
47474	62	47639	45	48116	214	4822319	190
47475	61	47640	38	48117	214	4822320	190
47476	61	47641	60	48118	214	4822321	190
47478	60	47642	60	48119	214	4822322	190
47479	60	47647	38	48120	214	4822323	190
47480	60	47801	291	48121	214	4822324	190
47481	60	47802	291	48122	214	4822325	191
47482	60	47803	292	48123	214	4822326	191
47484	61	47804	292	48124	214	4822327	191
47485	61	47805	292	48125	214	4822328	191
47486	61	47806	292	48126	180	4822329	191
47487	61	47807	292	48127	214	4822330	191
47488	61	47808	293	48128	214	4822331	200
47489	61	47809	293	48129	214	4822332	185
47491	60	47810	293	48130	214	4822333	191
47494	57	47811	293	48131	178	4822334	191
47494B	57	47812	293	48132	209	4822335	191
47494S	57	47814	293	48134	216, 311	4822336	191
47498	54	47815	183	48135	216	4822337	191
47499	54	47816	183	48137	216	4822338	191
4750...	258	47817	292	4820101	294	4822339	192
47501	55	47818	292	4820106	294	4822340	192
47502	27	47819	292	4820107	294	4822341	192
47503	27	4782...	257	4820110	294	4822342	192
47504	27	47820	292	4820111	294	4822343	192
47505	41	47824	291	4820207	294	4822344	192
47513	60	47825	292	48203	294	4822345	192
47514	60	47826	174	48203210	294	4822346	192
47515	60	47827	174	48203300	294	4822347	192
47516	60	47828	259, 312	48203460	294	4822348	193
47517	59	47829	293	48203610	294	4822349	193
47518	59	47830	293	4820503	205	4822350	193
47519	56	47831	293	4820509	205	4822351	193
47520	56	47832	294	4820513	205	4822352	193
47521	56	47901	291	4820514	204	4822353	193
47522	55	47902	292	4820515	202	4822354	193
47523	59	47903	292	4820516	202	4822355	193
4753...	258	47904	292	4820517	203	4822356	193
47541	61	47905	292	4820518	203	48307...	180

4830801	174	601106	302	71103	297	7260...	298
4830802	175	601204	165, 247	7110301P	297	726131	75
4831101	288	601207	138	7110302P	297	726209	76
4831201	171	601209	166	71104...	296	726215	76
4831302	175	601210	166	71105	297	726216	76
487001	180	601218	166	7110501P	297	726219	76
487002	180	601219	166	7110502P	297	726231	76
		601223	166	7110503P	297	727...	298
5		601225	127	71201...	296	7271P	298
501401	164	601227	128	71202	297	727409	94
		601228	127	7120201P	297	727415	94
6		601229	127	7120202P	297	727416	94
600203	165	601230	127	7120203P	297	727419	94
600308	170	601231	126	71203	297	727709	78
600318	168	601232	127	7120301P	297	727715	78
600319	128	601305	279	7120302P	297	727716	78
600320	167	601306	279	7120303P	297	727719	78
600401	167	601307	280	71207...	296	727731	78
600402	165, 247	601401	165	7120701P	296	728406	71
600403	167	601404	137	7120702P	296	728528	119
600430	127	601406	129, 248	7120703P	296	728534	119
600432	127	601503	162	7120704	297	728907	108
600434	127	601506	137	7120704P	297	729509	90
600435	127	601601	138	71209...	296	729515	90
600436	167	601702	165	7120901P	296	729516	90
600437	167	601706	139	7120902P	296	729519	90
600439	167	601707	137	7120903P	296	730209	79
600503	161	601802	138	7121	297	730215	79
600506	168	601903	126	7121204P	297	730216	79
600507	165	601904	126	7121205	297	730219	79
600512	161	602006	161	7121205P	297	730231	79
600513	124	602103	138	713...	298	731...	302
600514	162	602104	139	713201	116	73110420P	302
600603	161	602105	139	713202	116	73121060P	302
600614	128	602204	142	7135	299	731220100P	302
600618	161	602205	127	7135550	298	7313P	302
600619	161	602209	137	714...	298	73141000P	302
600620	161	602302	137	714040	69	7314P	302
600621	278	602303	162	715...	299	73151000P	302
600622	280	602304	138	71501...	308	7315800P	302
600623	128	602406	136	71502...	267	732...	302
600624	288	602407	130	7150310	172	73210525P	302
600701	165, 247	602603	165	71511P	299	7322P	302
600705	128	602605	143	71516...	262	7323P	302
600708	126	602708	130	71518...	262	7324550P	302
600709	127	602709	130	71521P	299	7324750P	302
600712	278	602803	144	7152450	298	7325P	302
600713	278	602904	131	715261...	264	732809	92
600716	278	603002	136	715281...	264	732815	92
600717	124	603003	136	71531P	299	732816	92
600718	124	603004	127	71536...	265	732819	92
600719	124	603101	139, 249	71623	299	733809	80
600806	165, 247	603102	143	71632	299	733815	80
600813	280	603202	140	716931	73, 250	733816	80
600822	128	603506	130	717...	269	733819	80
600823	124	603601	138	71712...	269	733831	80
600824	124	603701	136	71713...	269	733909	84
600825	128	603903	136	71722...	269	733915	84
600826	124	604001	143	71723...	269	733916	84
600828	278	604002	136	717331	72	733919	84
600830	280	604101	136	71762...	264	733931	84
600902	280	604102	130	718...	298	734...	299
600907	302	604202	143	7184400	299	7344...	299
600908	302	604301	135	719...	299	7345...	299
600909	280	604601	136	720...	300	734511	96
600912	279	604702	136	7201001	300	734517	96
600913	124	604801	142	7202001	300	734518	96
600914	124	604901	137	720606	70	734520	96
600918	279	604903	142	720628	119	734529	96
600919	162	605301	142	720634	119	735...	299
600923	279	606901	142	7211	299	735231	251
600924	280			72225	300	736...	299
600925	278	7		723...	297	73645	299
600926	280	704721	117	7232P	298	736842	65
600927	278	706001	114	7233600	298	736931	81
600928	139	706201	118	7233601	298	73721	300
601001	161, 259	709101	115	7233P	298	737512	241
601003	247, 280	709412	243	723931	74	737709	82
601006	279	709601	117	72401	298	737715	82
601007	278	71101...	296	724842	64	737716	82
601008	279	7110101P	296	724912	244	737719	82
601014	167	7110102P	296	725109	77	737731	82
601015	167	711013P	296	725115	77	739009	85
601016	126	71102...	296	725116	77	739015	85
601017	126	7110201P	296	725119	77	739016	85
601103	126	7110202P	296	725131	77	739019	85
601105	302	7110203P	296	726...	298	739131	85

746009	86	810005	181	828001	174	829090	235
746015	86	81037...	304	82848...	306	829091	235
746016	86	811002	175	82890...	306	829092	235
746019	86	811003	175	829001	176	829093	236
746929	97	81137...	304	829002	178	829094	236
747115	87	812001	179	829003	181	829095	236
747131	87	812002	171	829004	173	829096	236
747243	66	812003	174	829005	176	829097	237
748512	100	812005	184	829006	172	829098	237
748517	100	812006	178	829007	170	829099	237
748518	100	812007	175	829008	173	829100	237
748520	100	81237...	304	829009	173	829101	238
748529	100	813001	169	829015	218	829102	238
751...	312	813002	169	829016	218	829103	238
75101	311	813003	285	829017	218	829104	238
75103	312	81302	169	829018	218	829105	239
75104	311	81303	169	829019	218	829106	239
75115	311	81304	169	829020	219	829107	239
75166	311	81305	169	829021	219	829108	239
75184	311	81306	169	829022	219	829109	239
75185	311	81307	169	829023	219	829110	171
75190	311	81308	169	829024	219	829111	173
75191	311	81309	169	829025	220	82948...	306
75193	312	81310	169	829026	220	82990...	306
75194	312	81311	169	829027	220	830100...	307
752709	88	81337...	304	829028	220	830140...	307
752715	88	814...	179	829029	221	83406...	306
752716	88	814137...	252, 304	829030	221	834100...	306
752719	88	81437...	304	829031	221	8341062...	307
752731	88	815001	55	829032	221	834140...	307
753311	99	81537...	304	829033	222	83414062...	253
753317	99	816001	178	829034	222	83424806	307
753318	99	816137...	304	829035	222	836062...	307
753320	99	81637...	304	829036	222	836100...	307
753329	99	817006	173	829037	222	836140...	307
753909	89	817007	174	829038	223	83706...	307
753915	89	81737...	304	829039	223	837100...	307
753916	89	818001	180	829040	223	83805517	174
753919	89	818002	181	829041	223	83806...	308
753931	89	818003	181	829042	224	838100...	308
754007	109	818004	181	829043	224	838140...	308
757511	102	818007	174	829044	224	83880...	308
757517	102	818008	181	829045	224	83906...	308
757518	102	818009	181	829046	224	839100...	308
757520	102	818010	182	829047	225	83912011	308
757529	102	818011	182	829048	225	83914010	308
757544	112	818012	182	829049	225	839240...	309
760508	110	818014	182	829050	225	86807818	309
760544	113	818015	182	829051	226	86907...	308
760546	106	818016	182	829052	226	87810518	309
764408	111	818017	182	829053	226		
764411	104	818021	183	829054	226		
764417	104	818023	183	829055	227	9	
764418	104	818024	183	829056	227	91125...	309
764420	104	818025	184	829057	227	91325...	309
764429	104	818026	172	829058	227	91425...	309
		818028	183	829059	228	91825...	309
		818030	172	829060	228	92130...	309
8		81837...	305	829061	228	92136...	309
801003	176	819001	183	829062	228	92230...	309
801016	176	819002	183	829063	228	92330...	309
801018	176	819005	181	829064	229	92336...	310
801206	172	819008	184	829065	229	92430...	310
801305	173	819009	182	829066	229	92436...	310
802214	173	81937...	305	829067	229	92630...	310
803001	167	820005	170	829068	230	92830...	310
803003	175	820006	183	829069	230	93430...	310
803004	168	820007	178	829070	230	93475...	310
803005	168	820011	170	829071	230	93630...	310
805001	172	820012	170	829072	231	93675...	310
805002	177	82090...	305	829073	231	93830...	310
805003	167	821001	168	829074	231	93875...	310
805007	184	82148...	305	829075	231		
80501...	176	822001	174	829076	231	A	
805012	181	822002	174	829077	232	ASE27600100000	21
805013	184	82248...	305	829078	232	ASE27600300000	15
805015	171	82348...	305	829079	232		
805016	174	824148...	252	829080	232	S	
805017	183	82418...	305	829081	233	S403	153
805018	178	82448...	305	829082	233	S404	153
805019	267	82490...	305	829083	233	S407	153
806001	173	825001	178	829084	233	S409	153
807001	164	826001	182	829085	234	S409-1	153
808001	179	82648...	305	829086	234	S413	153
809007	177	82690...	306	829087	234		
810002	170	82748...	306	829088	234		
810003	174	82790...	306	829089	235		
810004	174						

Alpha index

A		CATALOGUE	311
ADAPTOR	299	CENTER PUNCH	289
ADAPTOR SET	164	CHISEL	288
ADAPTOR SET, ON RAIL	159, 164	CHISEL SET, SFS	128, 137, 138, 139, 143
ADAPTORS FOR DRILLS	173	CIRCLE NOSE PLIERS	286
ADJUSTABLE WRENCH	276	CIRCLIP ASSORTMENT	189
AIR CONDITIONER TOOL SET	183, 184	CLAMP TENSIONER CV BOOT TOOL	178
AIR HOSE REEL	186	CLEANING BRUSH KIT	178
ALTERNATOR BIT SOCKET	173	CLEVIS PIN ASSORTMENT	191
ALTERNATOR TOOLS	173	CLIP REMOVAL PLIERS	170
ANGLE WRENCH	276	CLIP REMOVER	167
ANGLE WRENCH SET, SFS	126	CLUTCH ALIGNER SET	180, 181
ASSORTMENT SETS	189-193	COMBINATION PLIERS	284
AUXILIARY DRIVE BELT WRENCH	235, 238	COMBINATION SET, BMCS	146, 147, 148
AXIAL JOINT TOOL	183	COMBINATION SET, SFS	125, 130, 131, 132, 133, 134, 141
B		COMBINATION SET SAE, SFS	129, 248
BALL JOINT SEPARATOR	179	COMBINATION WRENCH	274
BALL JOINT SOCKET	308	COMBINATION WRENCH, SAE	253, 274
BALANCE SHAFT SETTING KIT	237, 238	COMBINATION WRENCH SET	165
BATTERY CHARGER	215	COMBINATION WRENCH SET, SAE	165, 247
BELT GAUGE	181	COMBINATION WRENCH SET SAE, SFS	129, 248
BIN DRAWER FOR MSS	60	COMBINATION WRENCH SET, SFS	126, 127, 131
BIT HOLDER	300	COMMON RAIL FLOW METER	181
BIT SET	162, 164	COMPRESSION TEST SET	182
BIT SOCKET	174, 304-309	CONNECTORS ASSORTMENT	190
BIT SOCKET, SAE	252, 253	COTTON PIN DRIVER	167
BIT SOCKET SET	163, 164	COTTON PIN PULLER	292
BIT SOCKET SET, BMCS	146, 148, 149, 150	CRANKSHAFT HOLDING TOOL	235, 237
BIT SOCKET SET, ON RAIL	156, 157, 158, 159	CRAW FOOT SET	179
BIT SOCKET SET, SFS	125, 126, 133, 134, 135, 140	CREEPER	180
BIT SOCKET SET SAE, ON RAIL	156, 157, 158, 247	CRIMP TERMINALS ASSORTMENT	191
BIT SOCKET SET SAE, SFS	129, 248	CRIMPING PLIERS SET	169
BITS	309, 310	CROCODILE CLIPS ASSORTMENT	190
BLIND HOLE BEARING PULLER SET	183	CROSS RIM WRENCH	171
BLIND RIVET ASSORTMENT	190	CUTTING SET, SFS	142, 143
BLOW CASE, EMPTY	153	CYLINDER PRESSURE METER SET	182
BLUE TOOTH SPEAKER	311	D	
BMCS (BLOW MOULD CASE STORAGE)	145-153	DAMPER PULLEY HOLDER WRENCH SET	171
BODY BOLTS AND SPEED NUTS ASSORTMENT	190	DIAGONAL PLIERS	284, 285
BOLT, NUT AND WASHER ASSORTMENT	190	DIESEL INJECTION PUMP TIMING KIT	236
BOLT TWISTER SOCKET SET	172, 173	DIESEL INJECTOR SEAT CLEANER SET	178, 181
BOOSTER SPARE PARTS	211	DIESEL INJECTOR SOCKET SET	181
BOOSTER	207-210	DISC RATCHET	297, 312
BOTTLE JACK	200	DISC RATCHET SET	162
BRAKE ADAPTOR SET	176	DOCUMENT HOLDER FOR TOOL BOX	56
BRAKE BLEEDER WRENCH SET	171	DOOR LOCK DISMANTLING TOOL	170
BRAKE CALIPER SERVICE SET	176, 177	DOUBLE OPEN WRENCH	273
BRAKE CALIPER SOCKET	267	DOUBLE OPEN WRENCH, SAE	253, 273
BRAKE FLUID TESTER	174	DOUBLE OPEN WRENCH SET, SAE	165, 247
BRAKE PIPE CORROSION TOOL	176	DOUBLE OPEN WRENCH SET, SFS	126
BRAKE PISTON REWINDING CUBE	178	DOUBLE RING WRENCH	276
BRAKE PISTON SPINDLE	176	DOUGHNUT STRETCHER	183
BRAKE TOOL SET	184	DRAIN PLUG GASKET ASSORTMENT	191
BUT CONNECTOR ASSORTMENT	192	DRAIN PLUG KEY SET	173
C		DRAWER RAILS	58
CABLE REEL	186	DRAWERS FOR MSS	60
CAMBELT TENSIONER TOOL SET	239	DRAWERS FOR SWS	60, 61
CAMBELT TENSIONER WRENCH	235, 237	DRAWERS FOR TOOL BOX	59, 60
CAMSHAFT ALIGNMENT KIT	229	DRAWERS FOR TOP BOX	60
CAMSHAFT HOLDING TOOL	234	DRAWERS FOR WORK BENCH	61
CAMSHAFT LOCKING SET	182	E	
CAMSHAFT SETTING TOOL	231, 235	E-CIRCLIP ASSORTMENT	189
CAMSHAFT TIMING TOOL	239	EMPTY TRAY FOR MSS, MWS	45
CAN HOLDER FOR TOOL BOX	56	ENGINE CRANE	200
CAP	311	ENGINE TIMING KIT	218-234
CAR SEAT COVER	180	EXTENSION	298, 299
CARDAN SOCKET	262, 264, 265	EXTENSION SET	172
CARDAN SOCKET SET, ON RAIL	157	F	
CASTERS FOR SERVICE CART	57	FEELER GAUGE	291
CASTERS FOR TOOL BOX	57	FENDER PROTECTION SYSTEM	180
CASTERS FOR TOP BOX	57		

FENDER PROTECTOR	180	KEY SETS	278-280
FILE	290	KEY WITH LOCK FOR STORAGE SYSTEMS	62
FILE SET, SFS	128	KNEE PAD	187
FILLED SUITCASES	114-116	KNIFE	290
FILLED TOOL BOXES	64-113		
FILLED TOOLBOX	118	L	
FILLED TOP BOXES	117, 119	LEAK BACK TEST SET	182
FITTING HOOK	183	LIGHTS	201-205
FLAG	311	LOCKING NUT ASSORTMENT	192
FLARE NUT WRENCH	276	LOCKING PLIERS	287
FLARE NUT WRENCH, SAE	253, 273	LONG NOSE PLIERS	284, 286
FLARE NUT WRENCH SET	165		
FLARE NUT WRENCH SET, SAE	165, 247	M	
FLARE NUT WRENCH SET, SFS	126	MAGNET	294
FLEXIBLE CABLE HOSE CLAMP REMOVING PLIERS	170	MAGNET PICK-UP	300
FOAM SPACER	128, 139, 144	MAGNETIC TRAY	180
FORK ROD SET	183	MEASURING TAPE	291
FRONT PANEL GUIDE SET	238	MEMO BLOCK	311
FRONT PULLEY HOLDING TOOL	239	METAL KNOP FOR MSS AND MWS SHELVES	60
FUEL LINE DISCONNECT SET	170	MIRROR	294
FUEL PUMP PULLER	236	MSS (MODULAR STORAGE SYSTEM)	36-53
FUEL SENDER/ PUMP CLAMPING RING REMOVAL TOOL	173	MULTI FUNCTION SOCKET SET	163
FUEL TOOL SET	184	MULTIMETER	187
FUSES ASSORTMENT	190, 191	MWS (MASTER WORK STATION)	32-35
G		N	
GEAR AND BEARING SPLIT TOOLS	178	NUT BREAKER SET	183
GLOVES	187	NUTS ASSORTMENT	190
GLOW PLUG PLIERS	286		
GLOW PLUG SOCKET	264	O	
GLOW PLUG SOCKET SET	172	O-RING ASSORTMENT	189
GREASE NIPPLE ASSORTMENT	190	OIL DRAIN PAN	180
GRILL COVER	180	OIL DRAIN REPAIR SET	176
GROMMET ASSORTMENT	190	OIL DRAIN SET	173
		OIL FILTER CAP	175
H		OIL FILTER PLIERS	288
HALF-MOON WRENCH	276	OIL FILTER SET	175
HAMMER	170, 289	OIL FILTER SET, SFS	127
HAMMER HEADS	170	OIL FILTER WRENCH	174, 175
HAMMER SET	170	OIL PRESSURE SET	182
HAMMER SET, SFS	128, 137, 138, 139, 143	OIL PUMP ALIGNMENT PLATE	239
HANDLE FOR TOOL BOX	55	OIL STOPPER SET	174
HEAT INDUCTOR GUN	188	OXYGEN SENSOR SOCKET	181
HEX BALL GRIP KEY	259	OXYGEN SENSOR WRENCH	181
HEX BALL GRIP KEY SET, SFS	124		
HEX KEY SET	167, 278, 279	P	
HEX KEY SET, SAE	247, 278	PANEL REMOVER	291, 292, 293
HEX KEY WRENCH	281	PAPER BASKET FOR TOOL BOX	56, 57
HEX KEY WRENCH, SAE	281	PAPER HOLDER FOR TOOL BOX	55
HEX NUT DRIVER	258	PENTAGON SOCKET SET	178
HEX NUT DRIVER SET, SFS	139, 143, 144	PETROL ENGINE TEST SET	182
HINGED DRIVER	273	PIN ASSORTMENT	189
HINGED SOCKET WRENCH	273	PIN PUNCH	288
HINGED SOCKET WRENCH SET, SFS	126	PIN PUNCH SET	288
HOLLOW PIN ASSORTMENT	189	PLIERS	283-288
HOOK	293, 294	PLIERS HOLDER FOR MSS AND MWS	45
HOOK FOR MSS, MWS	45	PLIERS SET, SFS	127, 128, 137, 138, 142, 143
HOOK SET	167	POCKET BITS	162
HOOK SET, SFS	128	POWER PACK	216, 311
HOSE CLAMP PLIERS	287, 288	PRECISION SCREWDRIVER SET	162
HOSE CLAMP PLIERS SET	170	PROPULSTATION	212-214
HOSE CLAMP SET	170, 190	PROTRACTOR	291
HOSE CLIP PLIERS	288	PRY BAR	168, 294
HOT AIR GUN	178	PRY BAR SET	167
		PRY REMOVER SET	168
I		PULLER	180
IMPACT ADAPTOR	299	PULLER SET	183
IMPACT ADAPTOR SET	164, 171	PULLEY WRENCH SET	171
IMPACT BIT SOCKET	308, 309		
IMPACT BIT SOCKET SET	164	R	
IMPACT DRIVER	162	RADIATOR HOSE REMOVER	292
IMPACT EXTENSION	299	RADIATOR PRESSURE TEST SET	182
IMPACT SOCKET	266-269	RATCHET 296, 297	
IMPACT SOCKET SET	164, 171, 172	RATCHET HANDLE	297
IMPACT SOCKET SET, SFS	125, 134, 135, 143	RATCHET SCREWDRIVER	161, 259
IMPACT UNIVERSAL JOINT	299	RATCHETING WRENCH	274, 275
INFRARED THERMOMETER	179	RATCHETING WRENCH SET	166
INJECTION PUMP WRENCH	275	RATCHETING WRENCH SET, SFS	126, 127
INJECTOR TOOL SET	181	REFRACTOMETER	174
INSERT HOLDER FOR BITS	300	REPAIR SET RATCHET	296, 297
		REPAIR SET SWIVEL HANDLE	298
J		REPAIR SET TORQUE WRENCHES	302
JACK	197, 198, 199, 200	REPAIR SET UNIVERSAL JOINT	299
JACK STANDS	200	REVERSIBLE PULLER	180
JACKET	312	RING WRENCH	275
		RING WRENCH, SAE	253, 275
K		RING WRENCH SET, SAE	165, 247
KEY CORD, 311		RING WRENCH SET, SFS	127
KEY FOR STORAGE SYSTEMS	62	RIVETING PLIERS	288
KEY RING	311	ROLLER SEAT	180

RUBBER MAT FOR TOOL BOX	54	TIMING CHAIN TENSIONER LEVER	236
RULE	291	TIMING TOOLS	218
S			
S7 TOOL BOX, EMPTY	12	TOOL BOX COVER	55
S7 TOOL BOX, FILLED	69	TOOL BOXES, EMPTY	12-24
S8 TOOL BOX, EMPTY	13	TOOL BOXES, FILLED	64-113, 250-251
S8 TOOL BOX, FILLED	70-71	TOOL HOLDER FOR TROLLEY	55
S9 TOOL BOX, EMPTY	14-15	TOOLBOX, EMPTY	26
S9 TOOL BOX, FILLED	64, 65, 72-85, 87-89, 250-251	TOOLS KIT SET, SFS	135
S10 TOOL BOX, EMPTY	16-17	TOOTH BELT TOOL SET	182
S10 TOOL BOX, FILLED	76-80, 82-95	TOP BLADE FOR TOOL BOX	54
S11 TOOL BOX, EMPTY	18	TOP BOXES, EMPTY	26
S11 TOOL BOX, FILLED	96, 99-105	TOP BOXES, FILLED	117, 119
S12 TOOL BOX, EMPTY	19-21	TORQUE MULTIPLIER	179
S12 TOOL BOX, FILLED	66-67, 96-107	TORQUE WRENCH SET	302
S13 TOOL BOX, EMPTY	22	TORQUE WRENCHES	302
S13 TOOL BOX, FILLED	108-109	TOWER PINCERS	285
S14 TOOL BOX, EMPTY	23	TPMS SET, BMCS	146
S14 TOOL BOX, FILLED	110-111	TRIM CLIP ASSORTMENT	192, 193
S15 TOOL BOX, EMPTY	24	TRIM PAD TOOL	292, 293
S15 TOOL BOX, FILLED	112-113	TRIM REMOVAL	292
SAFETY SET	178	TWIN CAMSHAFT LOCKING TOOL	219
SAMPLE SET, BMCS	147, 312	TWIST SOCKET SET	172
SAW	289	TX KEY SET	167
SCISSOR JACK	200	TX KEY WRENCH SET, SFS	124
SCISSOR JOINT PLIERS	286	TX SET	163
SCRAPER	291, 292	TX SET, BMCS	151
SCRAPER SET	167	TX WRENCH	276
SCREWDRIIVER	256-259	TYRE CARRIER	185
SCREWDRIIVER HOLDER FOR MSS AND MWS	45	TYRE PROFILE GAUGE	291
SCREWDRIIVER SET	161, 162	TYRE REPAIR TOOLS SET	174
SCREWDRIIVER SET, SFS	124, 130, 131, 139, 140	TYRE VALVE DRIVER	174
SEAL ASSORTMENT	189	TYRE VALVE STEM FITTING TOOL	174
SEALING RINGS ASSORTMENT	189	U	
SEPARATING FORK	183	UNIVERSAL JOINT	299
SERVICE CART	25	UNIVERSAL JOINT SET, ON RAIL	159, 164
SHEARS	289, 290	V	
SHELF FOR MSS	61, 62	VACUUM PUMP SET	182
SHELF FOR SWS	62	VALVE SETTING KIT	226
SHIRT	312	VERNIER CALIPER	291
SHRINK TUBE ASSORTMENT	192	VOLT CIRCUIT TESTER	187
SHRINKING HOSE ASSORTMENT	189	VOLTAGE TESTER	257
SIDE CUTTER	285	W	
SIDE TABLE FOR TOOL BOX	57	W-CLIP ASSORTMENT	189
SKIRTING BOARDS MSS	61	WALL DISPLAY	241-245
SKIRTING BOARDS SWS	61	WASHER ASSORTMENT	191
SLIDE HAMMER PULLER SET	179	WATER PUMP PLIERS	285
SLIDING T-HANDLE	298	WATER PUMP PULLER KIT	239
SNAP RING ASSORTMENT	189	WEDGE	168
SNAP RING PLIERS	285, 286	WEDGE SET	168
SNAP RING PLIERS SET, SFS	127	WHEEL HANGER SET	173
SOCKET	262-269	WHEEL SOCKET	266
SOCKET, SAE	252, 262, 263, 265	WHEEL SOCKET SET	171, 172, 173
SOCKET SET	162, 163, 164, 171, 172	WHEEL WEIGHT BALANCE PLIERS	288
SOCKET SET, BMCS	146-153	WING AND GRILL COVER	180
SOCKET SET, ON RAIL	156, 157, 158	WIPER REMOVAL KIT	179
SOCKET SET, SFS	124, 125, 126, 131, 134, 135, 140, 142	WIRE BRUSH	291
SOCKET SET SAE, ON RAIL	156, 157, 158, 247	WIRE STRIPPER	285
SOCKET SET SAE, SFS	129, 135, 139, 248, 249	WOODEN TOP BLADE FOR TOOL BOX	54
SOCKET SET IMPACT, SFS	125	WRENCHES	273-276
SPARK PLUG PLIERS	286	WRENCHES, SAE	253
SPARK PLUG SOCKET	269	WRENCH SET	165, 166
SPARK PLUG WIRE PULLER	170	WRENCH SET, BMCS	148, 150
SPEEDY GRIP	298	WRENCH SET, SAE	165, 247
SPINNER	298	WRENCH SET SAE, SFS	129, 139, 248, 249
SPIRAL SOCKET SET	172	WRENCH SET, SFS	126, 131, 134, 136, 142
SPRING COMPRESSOR	184, 194, 195, 196	X	
SPROCKET HOLDING TOOL	237	WEDGE SET	126
STAINLESS STEEL TOP BLADE FOR TOOL BOX	54	WHEEL SOCKET	194
STAR GRIP KEY	259	WHEEL SOCKET SET	128, 129, 130
STAR KEY SET	280	WHEEL WEIGHT BALANCE PLIERS	215
STAR KEY WRENCH	281	WING AND GRILL COVER	137
STRIPPING PLIERS	285	WIPER REMOVAL KIT	137
SUITCASES, EMPTY	27	WIRE BRUSH	217
SUITCASES, FILLED	114-116	WIRE STRIPPER	142, 211
SUMP PLUG REMOVAL TOOL	173	WOODEN TOP BLADE FOR TROLLEY	81
SUPPORT SHAFT FOR S10 GLASS TOOL BOX	55	WRENCHES	199-204
SWIVLE HANDLE	297, 298	WRENCH, SAE	123, 180
SWS (SONIC WORK STATION)	28-31	WRENCH SET	123
SYNCHRONISER RINGS ASSORTMENT	189	WRENCH SET, SAE	179
T			
TAPER PUNCH	289	WRENCH SET, MBS	110
TENSILE AND COMPRESSION SPRING ASSORTMENT	189	WRENCH SET SAE, SFS	104
TENT	312	WRENCH SETS, SFS	92, 93, 95, 100, 101, 107
TERMINAL RELEASE TOOL SET	184		
TEST LEAD SET	183		
TIE RAP HOLDER FOR MSS, MWS	45		
TIE RAPS	187		

**JOIN THE WINNERS
JOIN SONIC**



WINNING TEAM, EQUIPMENT.





SONIC EQUIPMENT BV
COMPONENT 114 - 116
1446 WP PURMEREND
THE NETHERLANDS
TEL. +31 299 437 000
FAX +31 299 436 610
INFO@SONIC-EQUIPMENT.COM
WWW.SONIC-EQUIPMENT.COM

WORK



SONIC TECHNICAL PARTNER
equipment

